

### BEFORE YOU BEGIN YOUR INSTALLATION



Shut off water supply



Flush hot and cold water supply lines



Required tools



Installation by License Professional Plumber



Flush the water pipe before installation



Drawings are for reference only



Do not disassemble the body

### FAUCET INSTALLATION

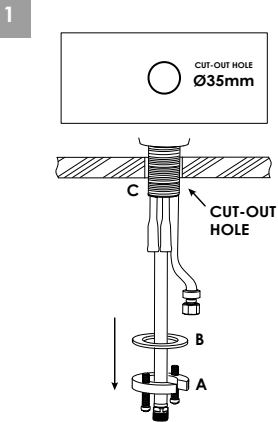

Ensure there is a  $\varnothing 35\text{mm}$  through-hole on the kitchen counter. Remove the mounting nut (A) and washer (B) from the threaded shroud (C).

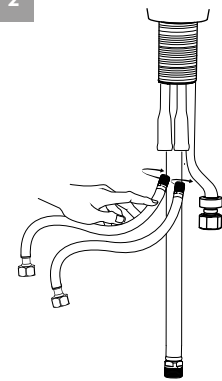

Connect braided supply hoses to faucet female outlets, secure firmly by hand until hose is snug to pipe.

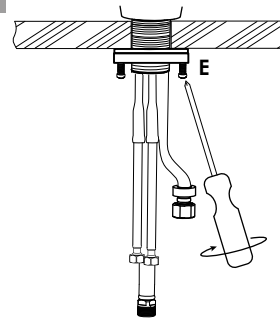

Position faucet on the installation surface. Fit flexible hoses through hole on countertop or sink.

Slide washer and thread the mounting nut onto threaded shroud. Turn faucet to desired handle position. Securely tighten clamp screws (E).

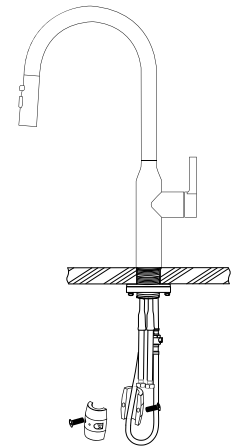

Connect pullout hose to quick connect and insert weight (loose-install).

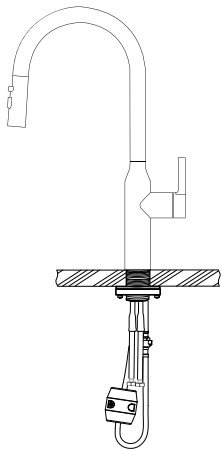

Secure weight on lowest vertical point on pull-out hose side. (not on quick connect side).

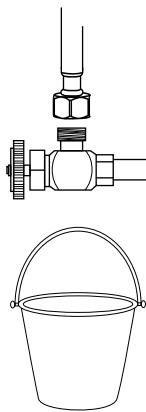

Before connecting supply hose, flush supply valves to clear any debris. Place a bucket underneath valves and run water for 5 to 10 seconds. Turn water off.

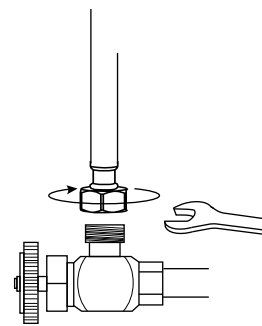

Connect hot and cold water lines to the inlet pipe and tighten with a wrench until snug. Do not over tight.

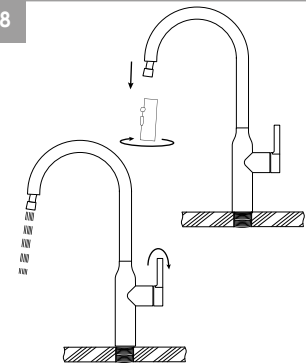

Unscrew spray head by hand. Hold the tip of the spray hose down and turn on the faucet and let the water run 60 seconds to flush any debris, the re-connect spray head. Ensure gasket is present.

### CARE AND CLEANING

Clean the faucet frequently using mild soap or an on-abrasive cleaner and then quickly rinse with water and dry with soft cloth only.

Using abrasive cleaners, solvents, acid cleaners or any scrubbing detergent, polisher or scraper will damage the finish and void the warranty.

### WARRANTY

For additional technical assistance or for any questions or concerns about your kitchen faucet's warranty, please contact us.

[www.stylishkb.com](http://www.stylishkb.com)

[care@stylishkb.com](mailto:care@stylishkb.com)

[www.stylishkb.com/warranty](http://www.stylishkb.com/warranty)

+1-855-789-5352

BEFORE YOU BEGIN YOUR INSTALLATION



Shut off water supply



Flush hot and cold water supply lines



Required tools



Installation by License Professional Plumber



Flush the water pipe before installation



Drawings are for reference only



Do not disassemble the body

FAUCET INSTALLATION

1

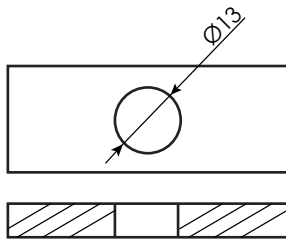

Ensure there is a Ø13mm hole diameter in the countertop.

2

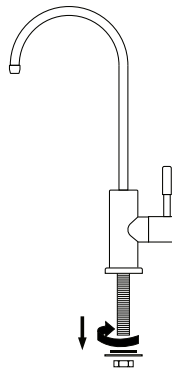

Remove the mounting nut from faucet.

3

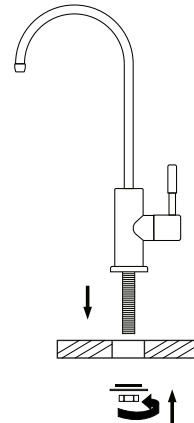

Insert faucet into countertop hole and secure mounting nut.

4

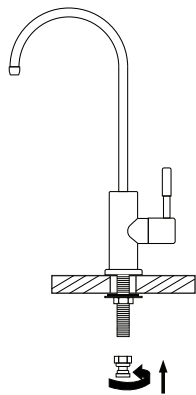

Connect the appropriate connector size. We include a 1/4" and a 3/8" connector. Attached supply hose (not provide with this water tap)

5

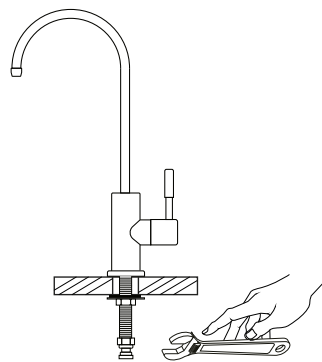

Tighten gently hose connection with a wrench.

6

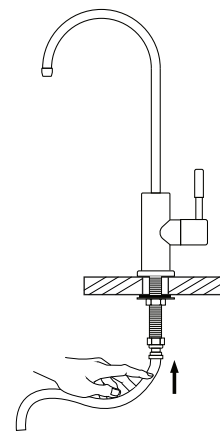

Check for any water leak or kinked hose and correct accordingly.

CARE AND CLEANING

Clean the faucet frequently using mild soap or an on-abrasive cleaner and then quickly rinse with water and dry with soft cloth only.

Using abrasive cleaners, solvents, acid cleaners or any scrubbing detergent, polisher or scraper will damage the finish and void the warranty.

WARRANTY

For additional technical assistance or for any questions or concerns about your faucet's warranty, please contact us.

[www.stylishkb.com](http://www.stylishkb.com)

[care@stylishkb.com](mailto:care@stylishkb.com)

[www.stylishkb.com/warranty](http://www.stylishkb.com/warranty)

+1-855-789-5352

## CONNECTION OPTIONS

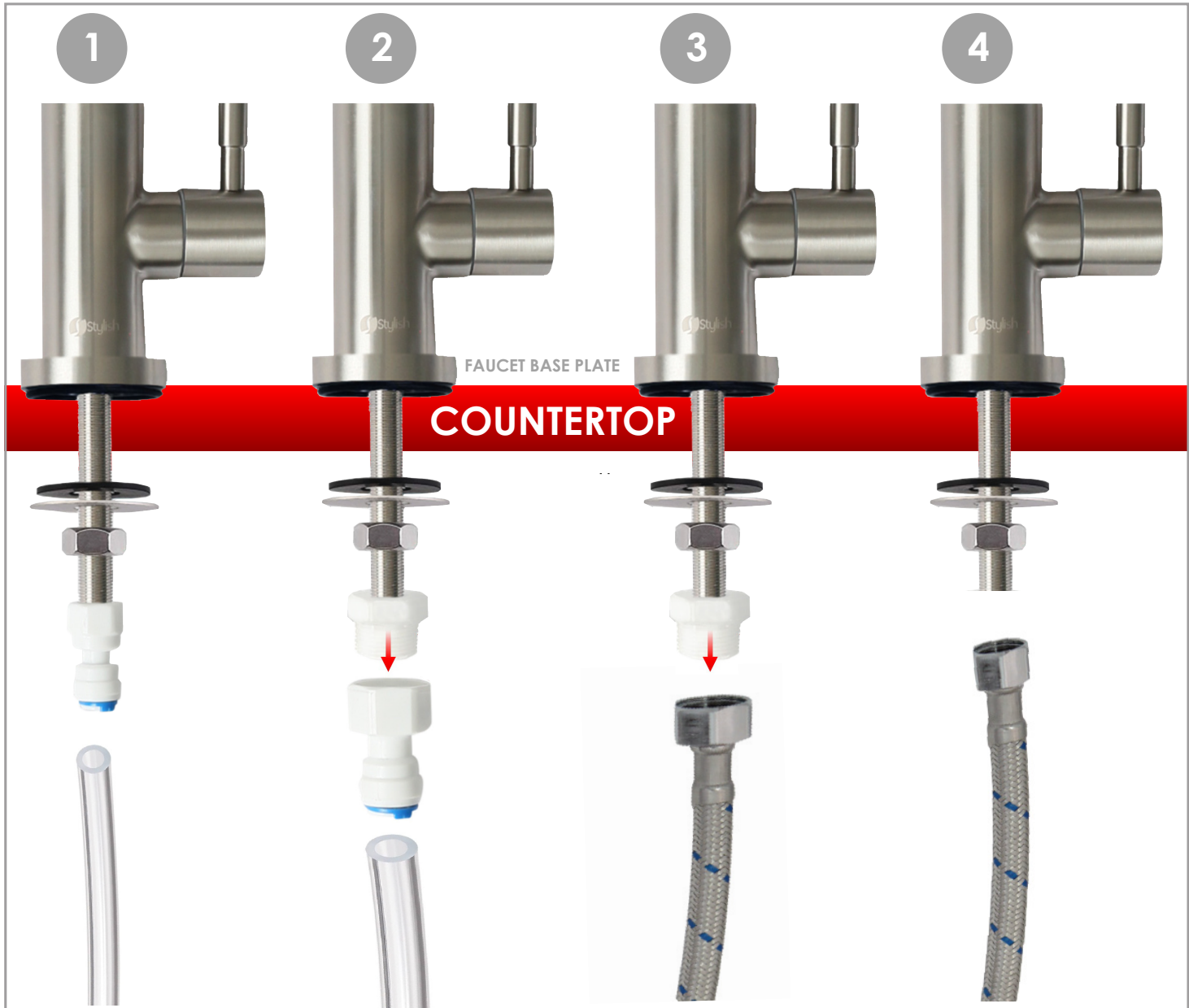

This faucet offers multiple connection options as shown in diagram

1.  $\frac{1}{4}$  inch hose to shark bite
2.  $\frac{3}{8}$  inch hose to shark bite
3.  $\frac{1}{2}$  inch to male connector (compression hose no included)
4.  $\frac{1}{4}$  inch compression hose direct to metal threaded rod (M11x1.5) (hose not included)