

# ASSEMBLY INSTRUCTIONS

---

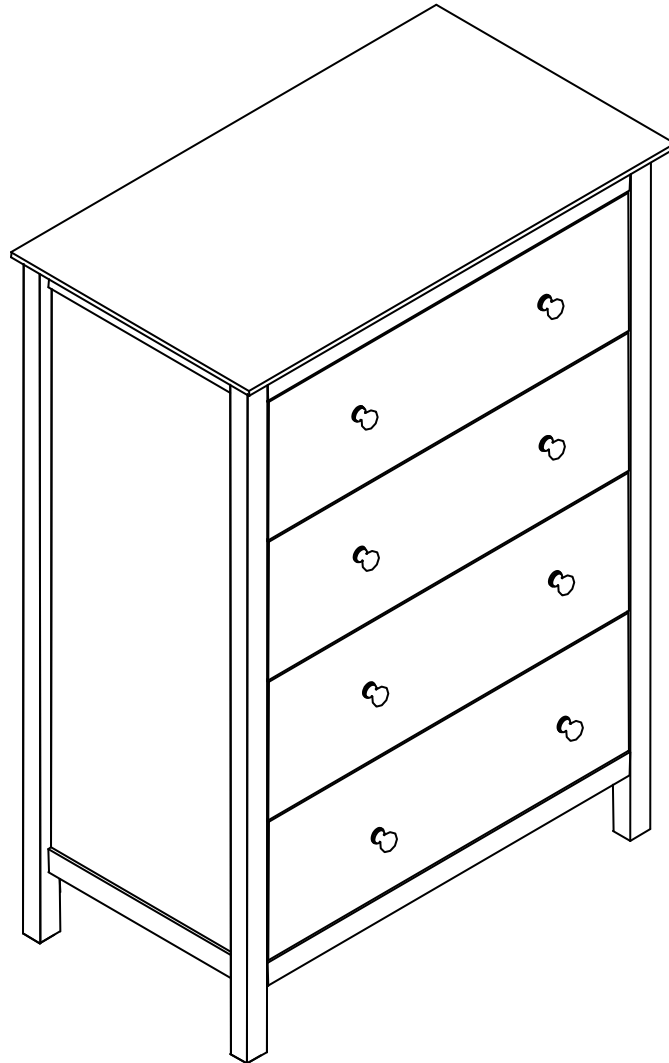

**WARNING!**

*Serious or fatal injuries can occur from furniture tip over. Use tip over restraint (provided) to secure this product to the wall.*

---

Description : BROOKLYN 4 DRAWER CHEST

Item No. : BD-8004

## BEFORE ASSEMBLY

Thank you for purchasing this quality product. This product has been designed for easy assembly and constructed for durability. All parts were checked prior to packaging to insure quality. Prior to beginning assembly, however, make sure all parts and hardware are included and free of obvious defect. If a part is missing or defective, please contact the store where purchased. If hardware is missing, or you need help with assembly, please call toll free 888-944-8396.

### IMPORTANT NOTE:

- Place all wooden parts on a clean and smooth surface such as a rug or carpet to avoid the parts from being scratched.
- Remove all wrapping material, including staples & packing straps before you start to assemble.
- DO NOT tighten all screws and bolts until completely assembled.
- Keep all hardware parts out of reach of children.

### WARNING:

Long exposure to rubber or soft plastic may cause a chemical reaction and damage the finish of your product. Protect the surface of the product with cloth if you are using any product with rubber feet or base.

### ASSEMBLY TOOLS REQUIRED NOT INCLUDED







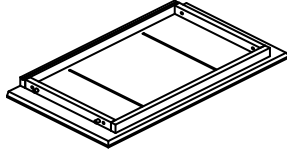
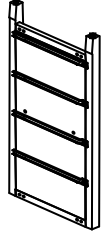
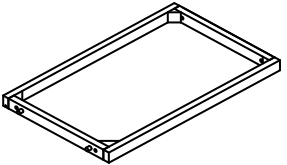
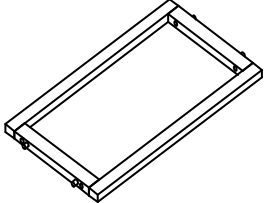
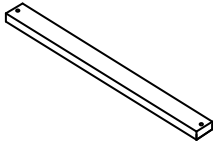
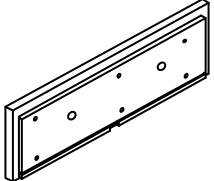
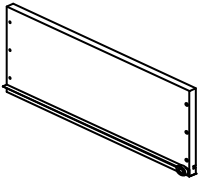
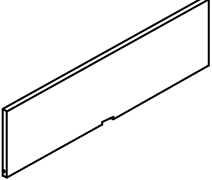
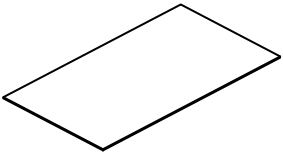
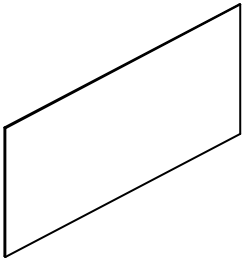
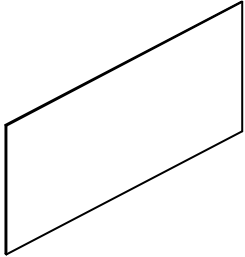

# PART LIST

When unpacking, please be careful not to discard any parts with the packaging. Before continuing, please make sure you have the following parts:

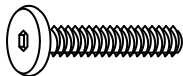
NO	Description	Qty	Sketch	NO	Description	Qty	Sketch
A	Top	1		B	Side panel (L-R)	2	
C	Bottom frame	1		D	Center frame	1	
E	Support bar	4		F	Drawer front	4	
G	Drawer side (L-R)	8		H	Drawer back	4	
I	Drawer bottom	4		J	Back panel upper (Large)	1	
K	Back panel lower (Small)	1					

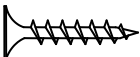
# HARDWARE LIST

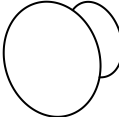
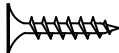
When unpacking, please be careful not to discard any parts with the packaging. Before continuing, please make sure you have all of the following hardware:

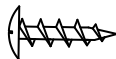
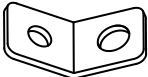
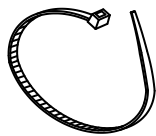
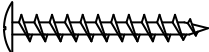
NO	Description	Qty	Sketch	NO	Description	Qty	Sketch
1	Allen key (M4 x 30mm x 110mm)	1		2	Bolt (M6 x 30mm)	12	
3	Spring Washer (Φ6.5 x 11mm)	12		4	Flat Washer (Φ6.5 x 13mm)	12	
5	Long Screw (M4 x 35mm)	48		6	Medium Pan head screw *Metal knob: (M4x22mm) *Wooden knob: (M4x25mm)	8	
7	Wooden Knob (Φ30 x 30mm)	8		8	Short Screw (M4 x 30mm)	8	
	<b>METAL KNOB</b> (Φ30 x 25mm) <b>GOES WITH FINISHED ITEM ONLY.</b>	8		10	Short Pan head screw (M4 x 15mm)	2	
9	Steel Tip Bracket	4		12	Flat Nylon Tie	2	
11	Long Pan head screw (M4 x 50mm)	2					

## NOTE: WARNING LABEL (INCLUDED)

<b>⚠ WARNING</b>	
	<p><b>Children have died from furniture tipover. To reduce the risk of furniture tipover:</b></p> <ul style="list-style-type: none"> <li>•ALWAYS install tipover restraint provided.</li> <li>•NEVER put a TV on this product.</li> <li>•NEVER allow children to stand, climb or hang on drawers, doors, or shelves.</li> <li>•NEVER open more than one drawer at a time.</li> <li>•Place heaviest items in the lowest drawers.</li> </ul>
	<p style="text-align: center;"><b><i>This is a permanent label. Do not remove!</i></b></p>

ITEM NO.: BD-8004  
REVISED MAR 20, 2020

Printed in Vietnam

## STEP 1

Attach top (A), center frame (D) and bottom frame (C) to side panel (B) with bolts (2), and washers (3) and (4) as shown below. Tighten with Allen key (1).  
Slide back panels (J) and (K) into the grooves, as shown below.

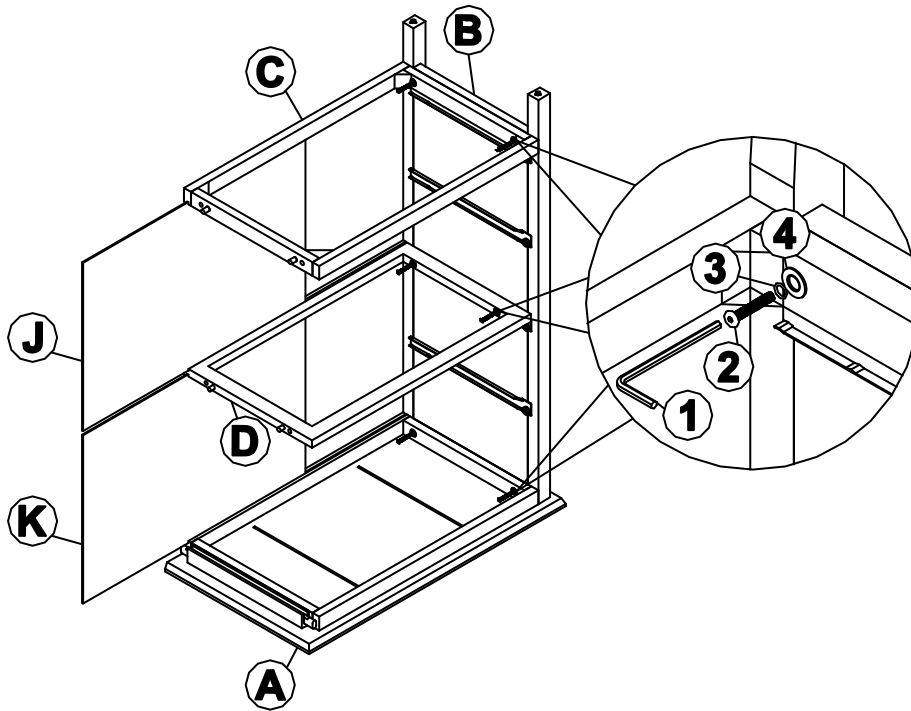

## STEP 2

Attach bottom frame (C), center frame (D) and top (A) to the other side panel (B) with bolts (2), and washers (3) and (4) as shown below. Tighten with Allen key (1).

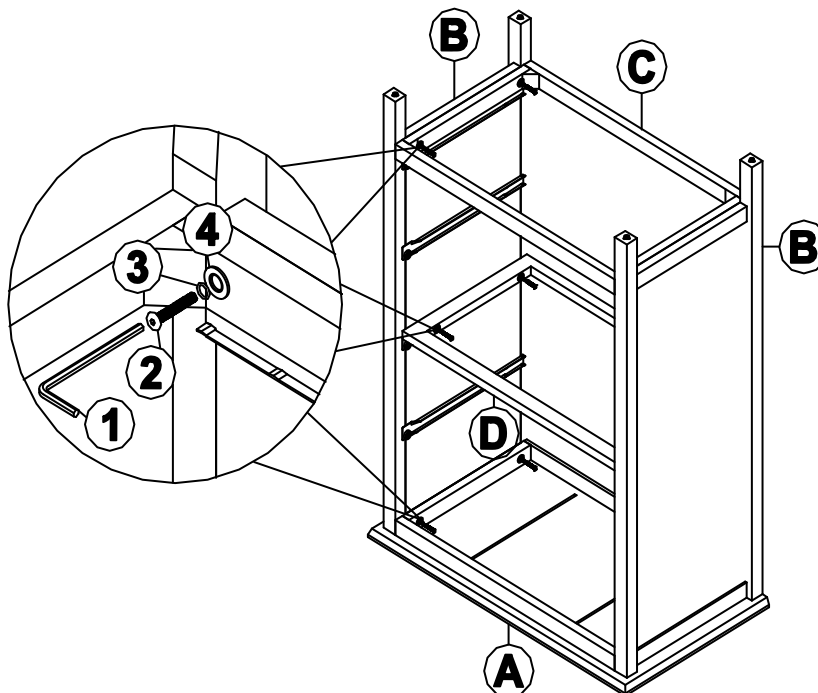

## STEP 3

Attach drawer sides (G) to drawer front (F) with screws (5) as shown below. Tighten with a screwdriver. Insert drawer bottom (I) into the grooves at bottom of drawer sides (G) and drawer front (F) as shown below. Attach drawer back (H) to drawer sides (G) with screws (5) as shown below. Tighten with a screwdriver.

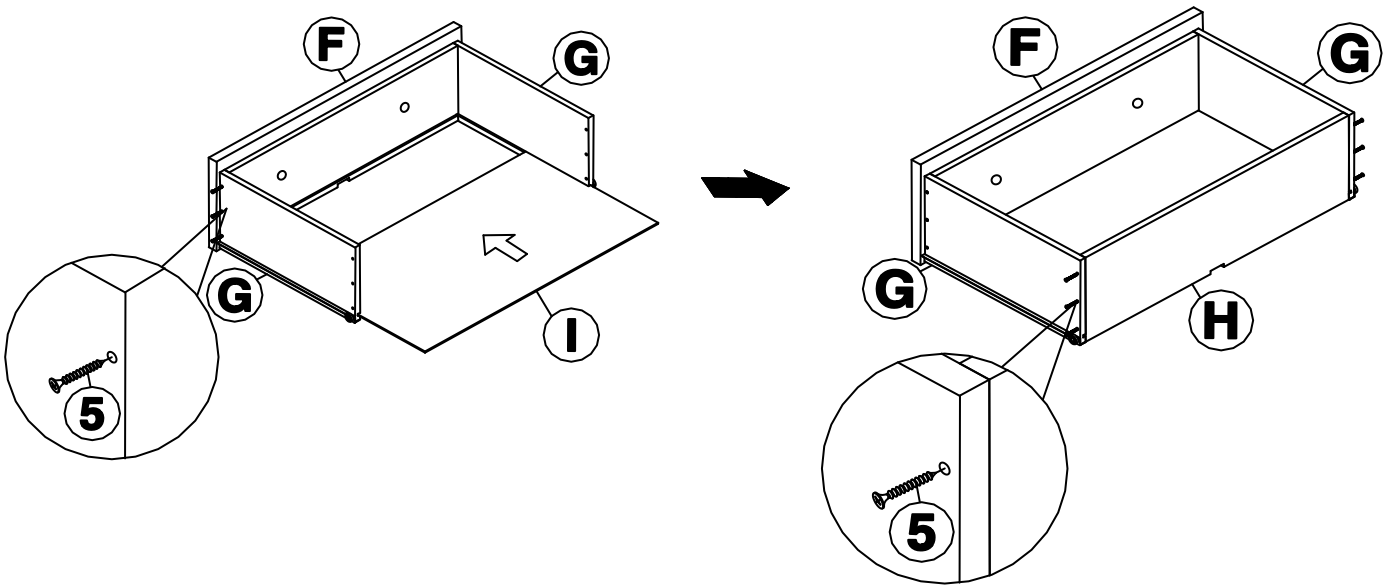

## STEP 4

Attach support bars (E) to bottom of drawers with screws (8) as shown below. Tighten with a screwdriver. Attach knobs (7) to front of drawers with pan head screws (6) as shown below. Tighten with a screwdriver. Carefully put the drawers into the unit.

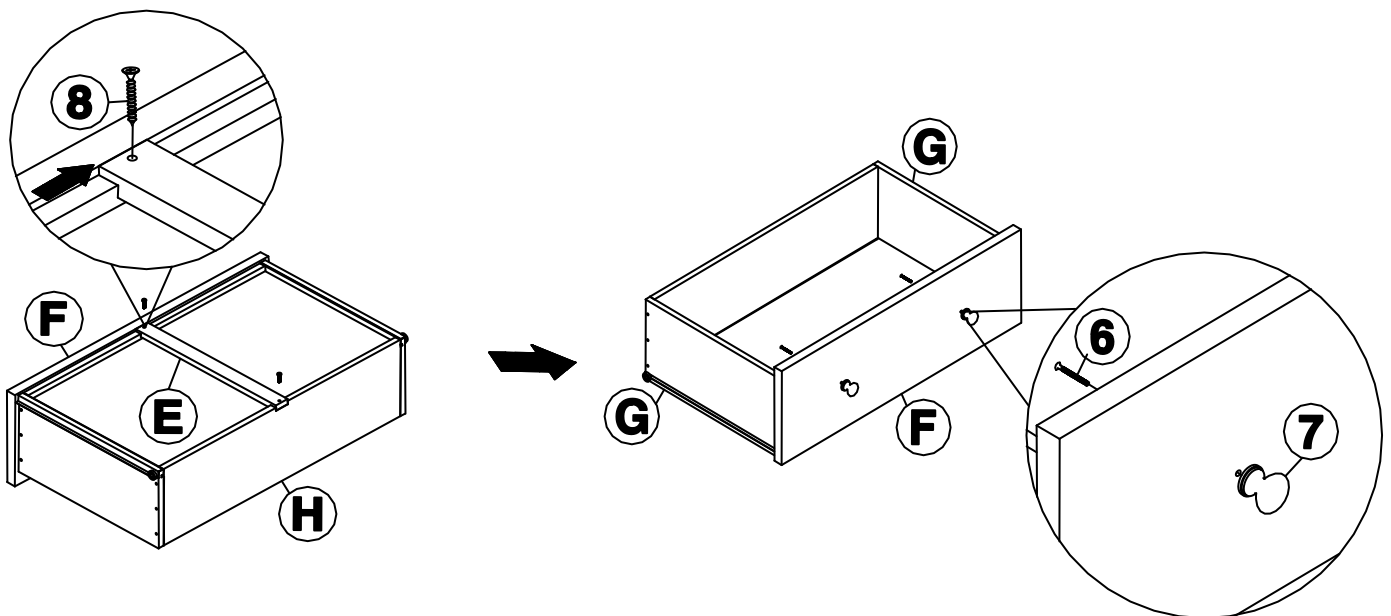

## STEP 5

Attach brackets (9) to the back of the unit with screws (10) through the smaller holes in the brackets as shown below.

### Important!

Properly attach the other brackets (9) to the wall in an area of ***drywall or plaster with a wood stud***: Mark the attachment point(s) with a pencil at the appropriate height **positioned over the wood stud(s) in the wall**.

Place the unit into position so both mounting brackets are vertically in line.

Adjust the levelers to the appropriate height to level the unit.

Properly attach the other brackets (9) to the wall stud with screws (11) through the smaller holes as shown below.

Lace the end of flat nylon ties (12) through the larger holes in each mounting bracket. Bring both ends together and slide the flat ends through the locking ends and draw it through until all slack is removed.

**Confirm that the strap is securely laced and locked.**

