



**INSTRUCTIONS D'ASSEMBLAGE
ASSEMBLY INSTRUCTIONS**

MONARCH
SPECIALTIES INC.

I 9758-1

**LUMINAIRE -
62"H LAMPE SUR PIED NOIR METAL / IVOIRE**

**LIGHTING -
62"H FLOOR LAMP BLACK METAL / IVORY SHADE**





**POUR DE L'ASSISTANCE OU POUR COMMANDER
DES PIÈCES CONTACTEZ NOTRE DÉPARTEMENT
DE SERVICE À LA CLIENTÈLE.**

**FOR ASSISTANCE OR TO ORDER PARTS
CONTACT OUR CUSTOMER SERVICE DEPARTMENT**

WWW.MONARCHSERVICE.COM

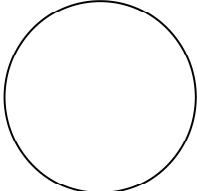
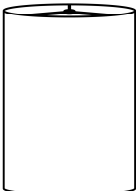
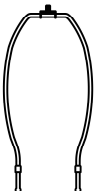
LISTE DES PIÈCES
PARTS LIST

| PIÈCE / PART # | IMAGE | DESCRIPTION | QTY / QTÉ |
|----------------|---|-------------------------------------|-----------|
| 1 |  | <p>FINIAL FAÎTEAU</p> | 1 |
| 2 |  | <p>SHADE ABAT-JOUR</p> | 1 |
| 3 |  | <p>HARP LYRE</p> | 1 |
| 4 |  | <p>LAMP BASE SOCLE DE LAMPE</p> | 1 |

ÉTAPE / STEP 1

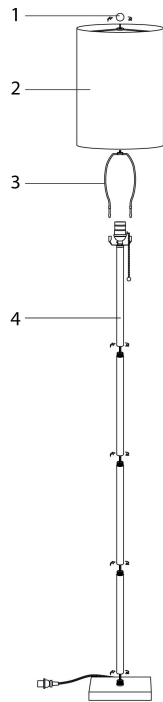

ÉTAPE / STEP 1

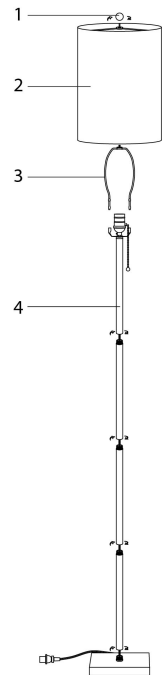

ÉTAPE / STEP 2

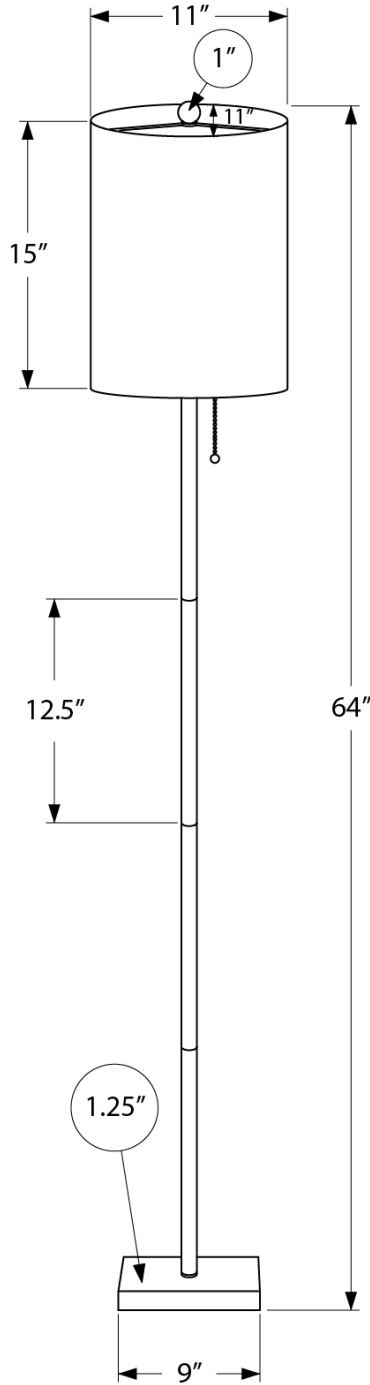

ÉTAPE / STEP 2

