

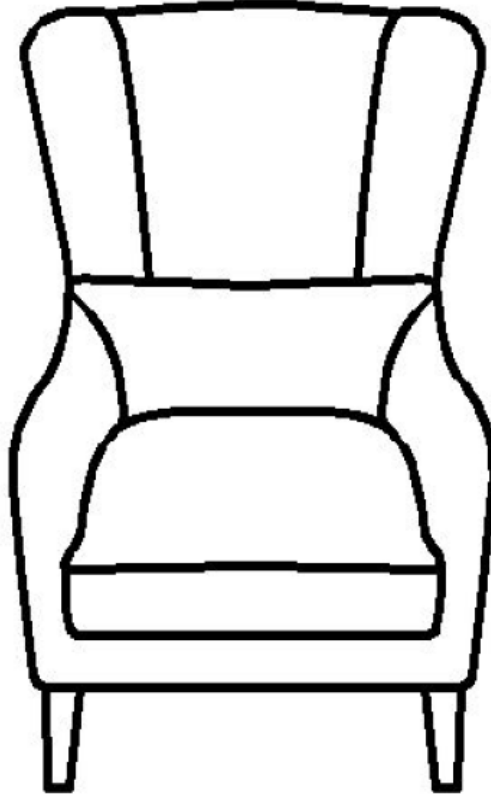



Assembly Instructions

Caution : You must read this before you proceed

Club Chair



Parts List

Label	Picture	Description	QTY
A		Chair	1
B		Front Wooden Legs	2
C		Hind Wooden Legs	2

Hardware

Label	Picture	Description	QTY
①		Washer Rings	7 pcs

Assembly Preparation

Before Beginning Assembly:

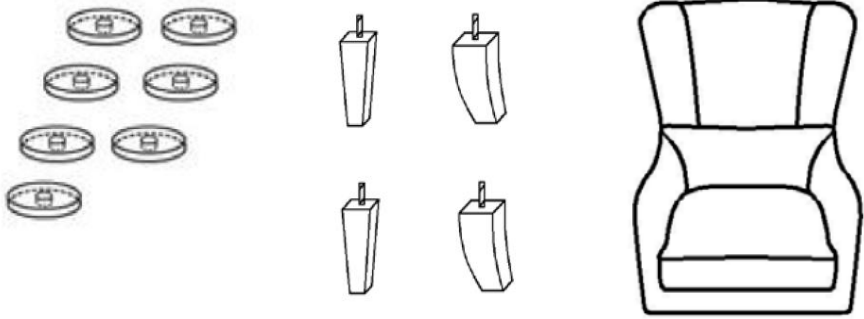

- Read instructions, cover to cover-



- Have 2 adults on hand for assembly-



- Do not assemble on flooring or carpet-



- Assemble on a clean non-marring surface (packing foam)-



- Save all packaging until finished-

Assembly Steps

Overview

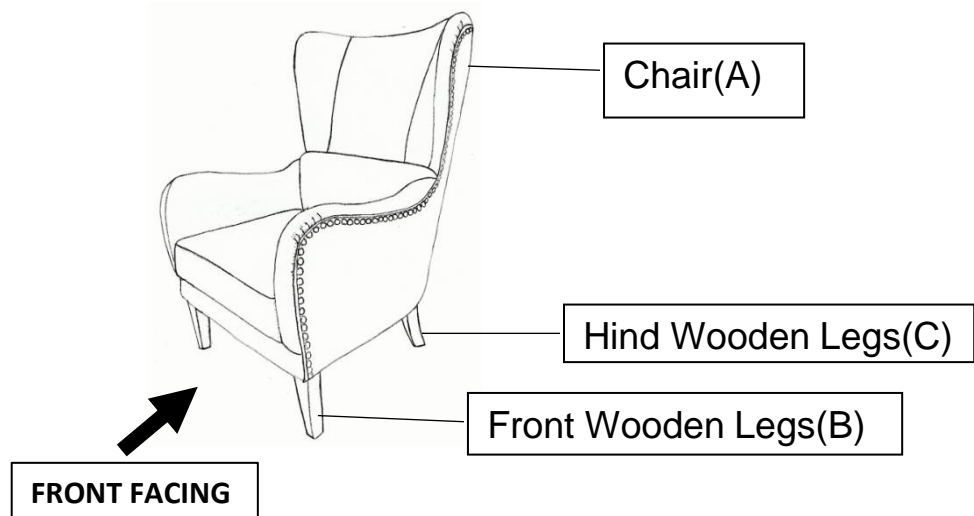

This Club Chair has multiple parts and may require up to some 30 minutes to assemble. To give you an overview of the Club Chair parts, the above picture is to help you put the various parts into perspective. Please read through the instructions below to familiarise yourself with the parts and steps before assembly.

Step 1

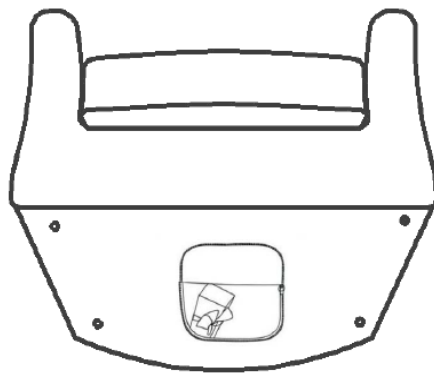

Position the Chair on its back, as shown.
Preferrably on a surface that will not scratch the upholstery.
Unzip pouch to open and remove the 4 wooden legs.
Close the pouch.

Step 2

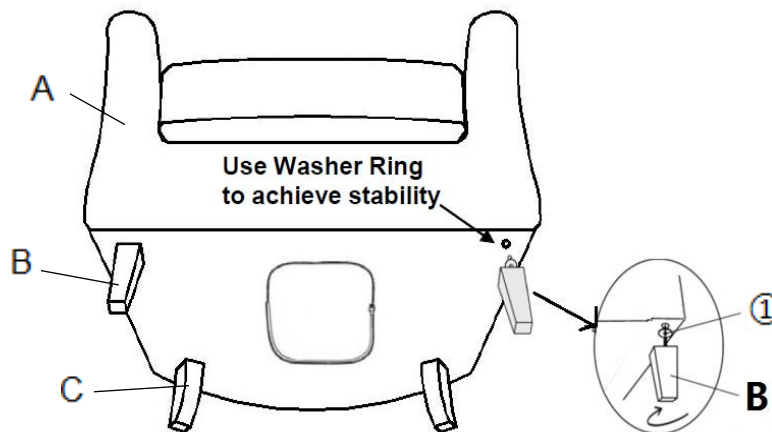

Install Leg into the Chair by putting a plastic washer ring (①) on the threaded Stem and then Insert the threaded Stem into the threaded Hole at each Corner of the Bottom of the Chair(A).

Tighten by turning Leg clockwise.

Repeat the same step to install the three remaining legs(B,C).

Note: The use of Gaskets are OPTIONAL and are especially useful to help alleviate slight wobbleness. Some Legs may need more than one gasket whilst some legs may not need any.

Step 3

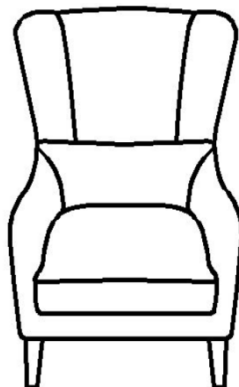

Make sure all parts are connected and locked into position.

Stand the Chair right side up.

Your chair is ready for use now.

This Club Chair can only be used on a flat, level surface.

Care & Maintenance



- Furniture may scratch floors. We recommend using furniture pads to protect your floors.



- Do not put hot items directly on furniture surface.



- Do not clean furniture with harsh cleansers or polish.



- Do not place furniture under direct sunlight.



- Do not place furniture near heating or cooling vents.



- Do not write on furniture without a padded barrier to protect the surface.



- Do not place furniture outside . For indoor use only.



- Not for commercial use. For residential use only.



- Stains may be removed with mild soap solution and damp cloth.



- Children should not climb or jump on the furniture.



- Dust and pick-up spills using a clean, non-colored, lint-free cloth.