

# Assembly Instructions

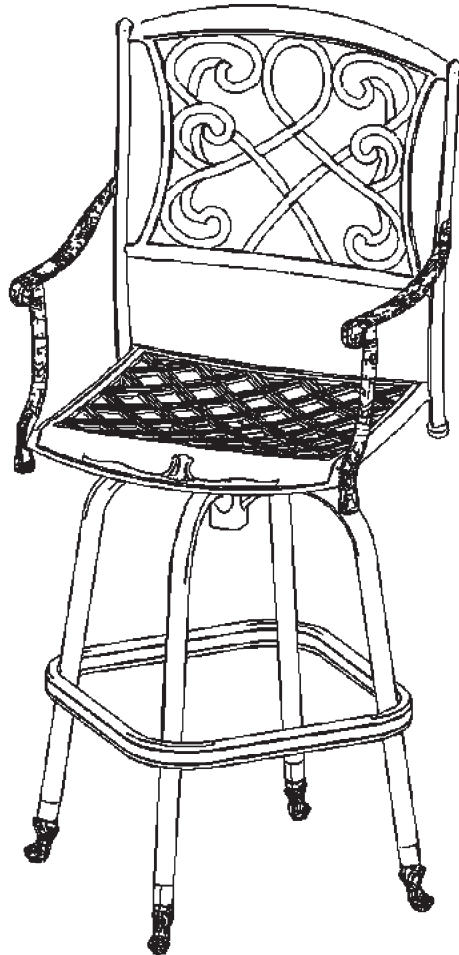

**Caution : You must read this before you proceed.**

## Swivel Barstool



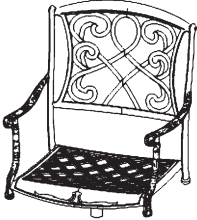

**CAUTION : This barstool is NOT a TOY.  
Keep your child / children at bay in the process of assembly.**

### Parts List

No.	Picture	Description	Qty
A		Barstool Seat	1
B		Iron Plate	1

c		Barstool Leg base With Pre-attached Leveller	1
---	---	--	---

## Hardware

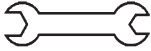
No.	Picture	Description	Qty
①		Bolts(M8*20mm)	5
②		Washers ( 8mm )	5
③		Springs Washers ( 8mm)	5
④		Spanner	1

## Assembly Preparation

Before Beginning Assembly:

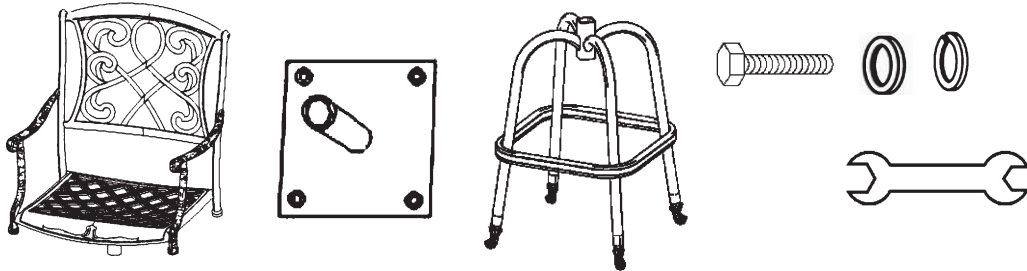

**Note:** There are extra hardware provided for this assembly.



- Read instructions, cover to cover-



- Have 2 adults on hand for assembly-



- Do not assemble on flooring or carpet-



- Assemble on a clean non-marring surface (packing foam)-



- Save all packaging until finished-

## Assembly Steps

## Overview

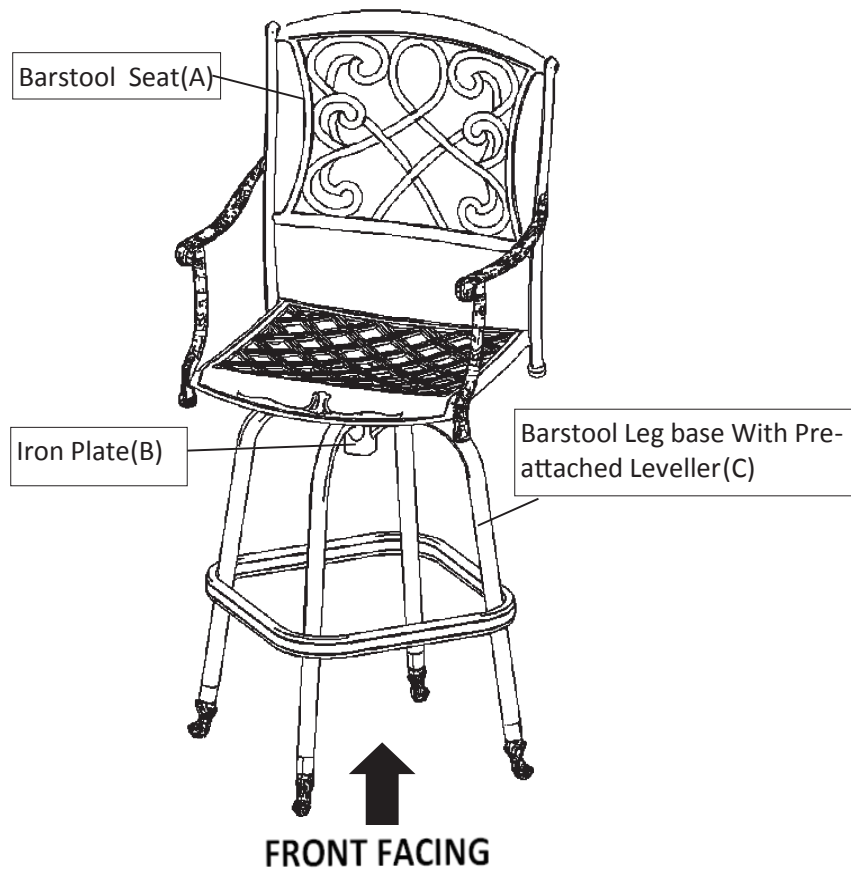

This Barstool has multiple parts and may require up to 30 minutes to assemble. To give you an overview of the Barstool parts, the above picture is to help you put the various Barstool parts into perspective. Please read through the instructions herebelow to familiarise yourself with the parts and steps before assembly.

## Step 1

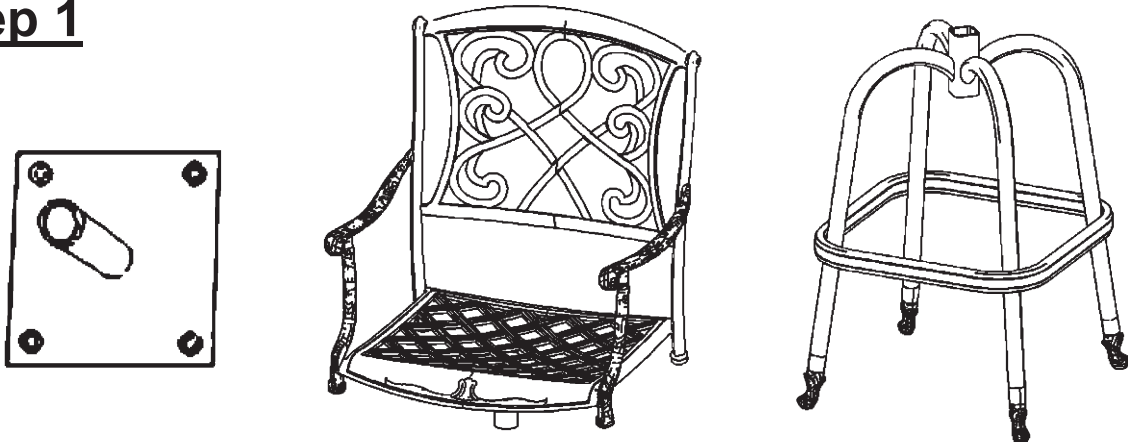

Place all parts on a clean soft surface.

## **Step 2**

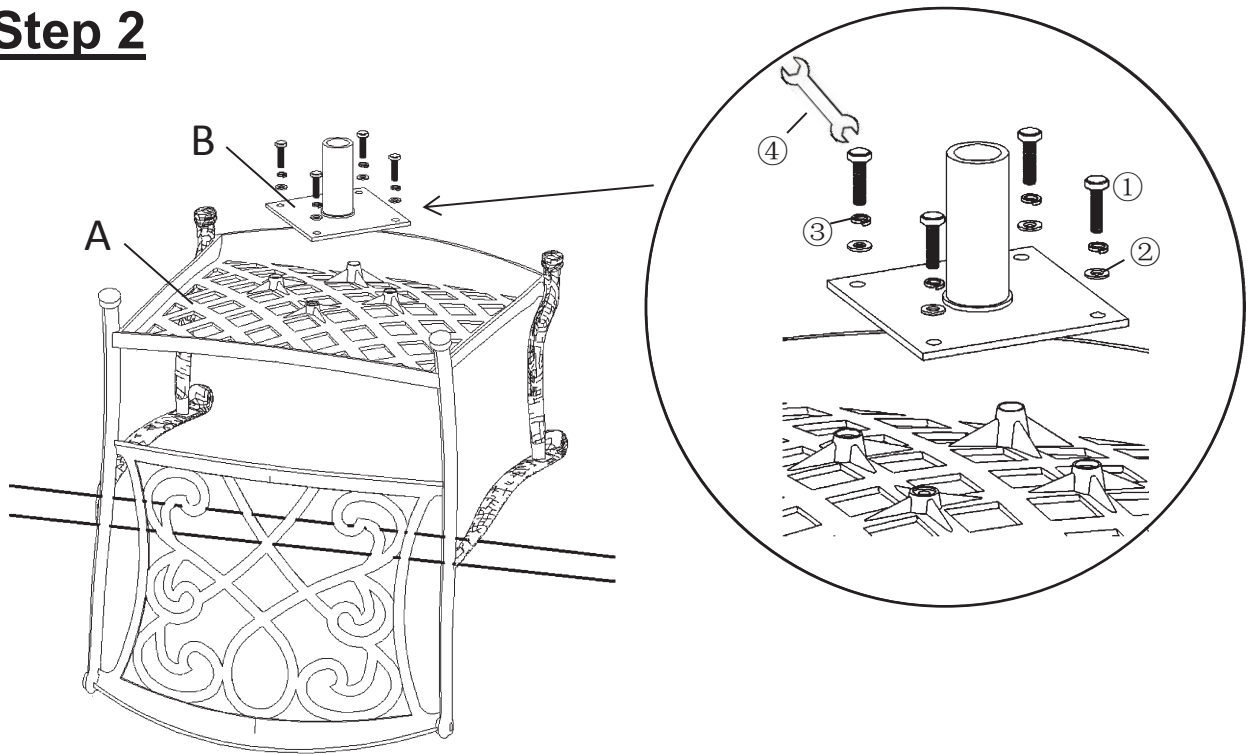

Place Barstool Seat onto the side of a table as seen in the picture.

Attach the Iron Plate(B) to the underside base of the Barstool Seat(A).

Align the mountings on the Iron Plate(B) with the mountings on the bottom of the Barstool Seat(A).

Insert bolts(①) from the mountings on the Iron Plate to the mountings on the seat.  
Put Flat washers(②) ,Spring washers(③) to the Blots,partially tighten all bolts into position.

Once all Bolts are in postion, use Spanner (④) to turn lock the Bolt.

**Do this in a sequential manner.**

## **Step 3**

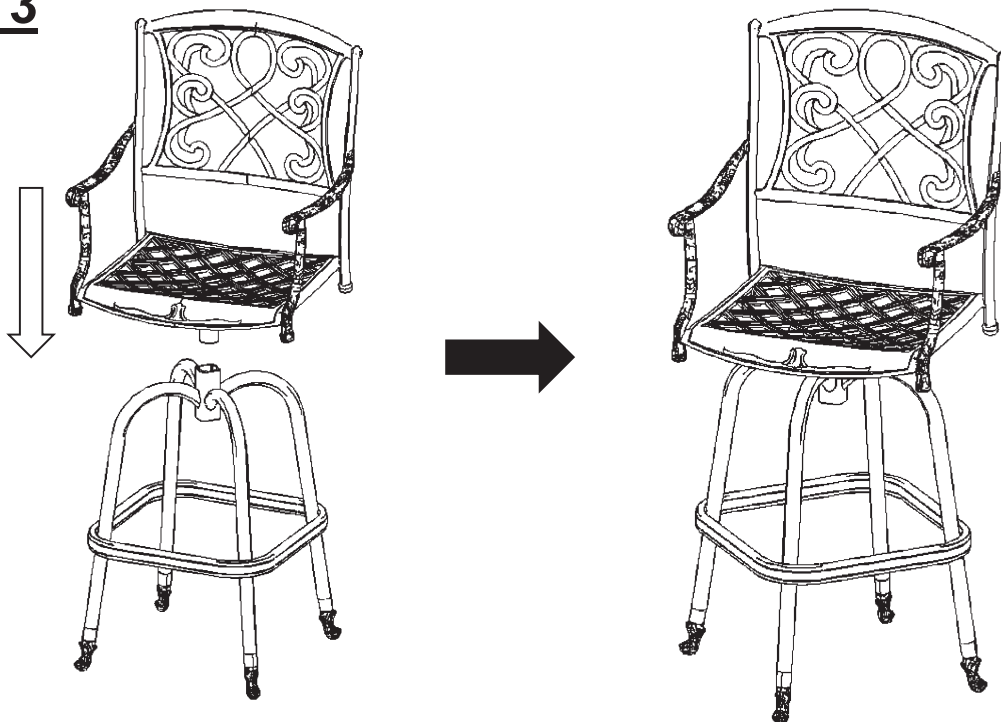

Turn the Barstool Seat(A) right side up.

Attach the Barstool Seat(A) with attached Iron Plate to the Barstool Leg Base With Pre-attached Leveller(C) as pictured above.

The Stem from the Iron Plate is to be aligned and fully inserted into the end of the Barstool Leg Base Stem.

Once into its housing, exert force and weight on the Barstool seat so as to force the Barstool Seat into a locking position into the Barstool Leg Base stem.

**Notes:if the Barstool seat (A) is not sliding into the Barstool base stem smoothly, apply extra grease to the base stem as to provide extra lubrication for assembly.**

## **Step 4**

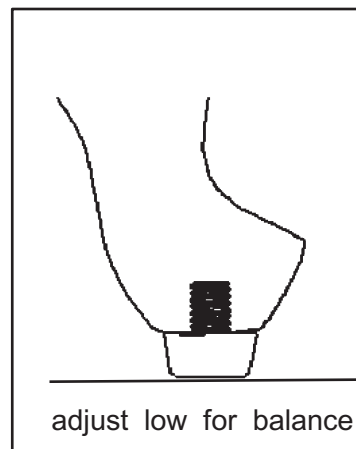
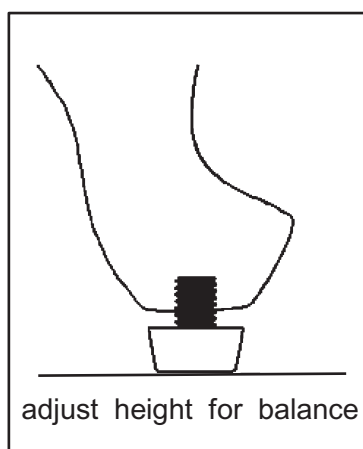
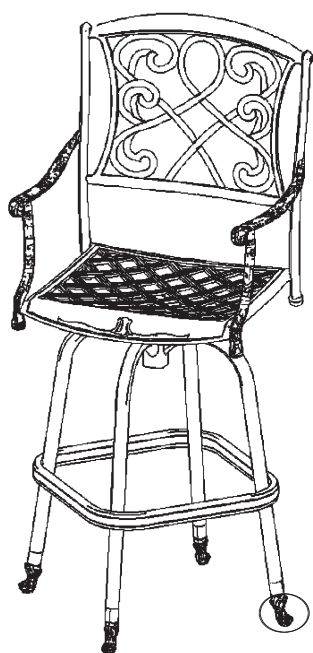

**CAUTION :** At this point, ensure all bolts are fully tightened and secured.

Then adjust the Legs Pre-installed Levellers until the table is level with the ground.









To adjust the Levellers, with the help from an adult partner, tilt the Barstool to rest on the 2 feet.

Adjust the levellers to the desired height to avoid wobbles.

**The Barstool is ready for use.**

**Caution: This Barstool can only be used on a flat, level surface.**

## Care & Maintenance

-  Do not put hot items directly on furniture surface.
  -  Do not clean furniture with harsh cleansers or polish.
  -  To obtain the longest lifespan of your outdoor products, minimizing exposure to direct sunlight is recommended.
  -  Children should not climb or jump on the furniture.
  -  Do not write on furniture without a padded barrier to protect the surface.
  -  To obtain the longest lifespan of your outdoor products, avoid extended and lengthy exposure to rain, snow, and direct sunshine. Whenever possible cover the product and /or place under patio or awnings.
  -  Not for commercial use. For residential use only .
  -  Stains may be removed with mild soap solution and damp cloth.
- 
-  Dust and pick-up spills using a clean, non-colored, lint-free cloth .