

Assembly Instructions

Caution: You must read this before you proceed

Chair

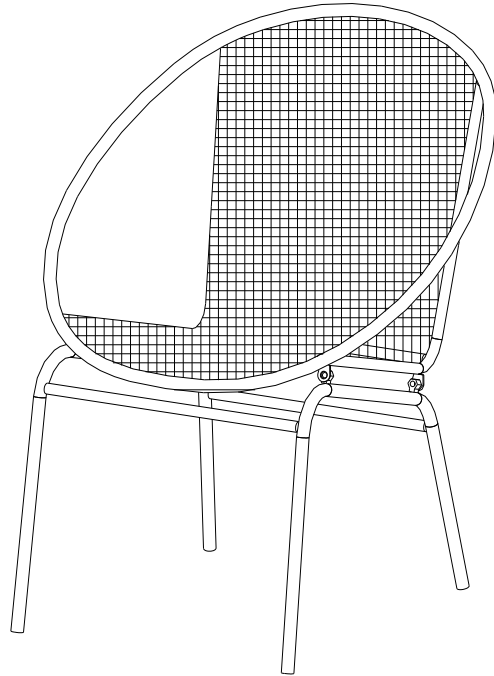

Part List

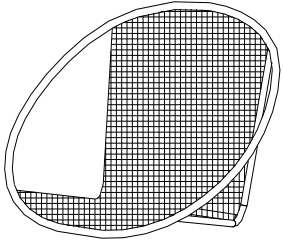
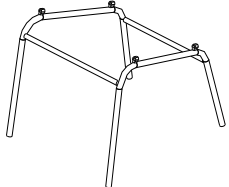
Label	Picture	Description	QTY
A		Chair Part	1
B		Leg Part	1

Hardware

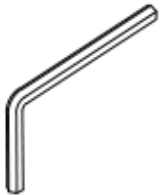
Label	Picture	Description	QTY
①		Bolt (M8*20mm)	5
②		Allen Key	1

Assembly Preparation

Before
Beginning
Assembly:

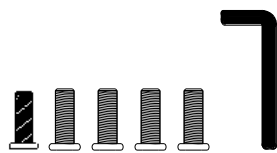
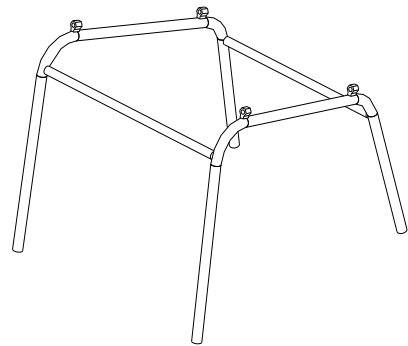
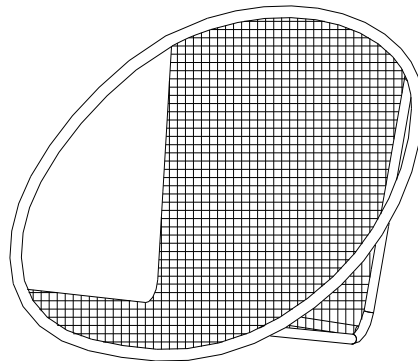

- Read instructions, cover to cover-



- Have 2 adults on hand for assembly-



- Do not assemble on flooring or carpet-



- Assemble on a clean non-marring surface (packing foam)-



- Save all packaging until finished-

Assembly Steps

Overview

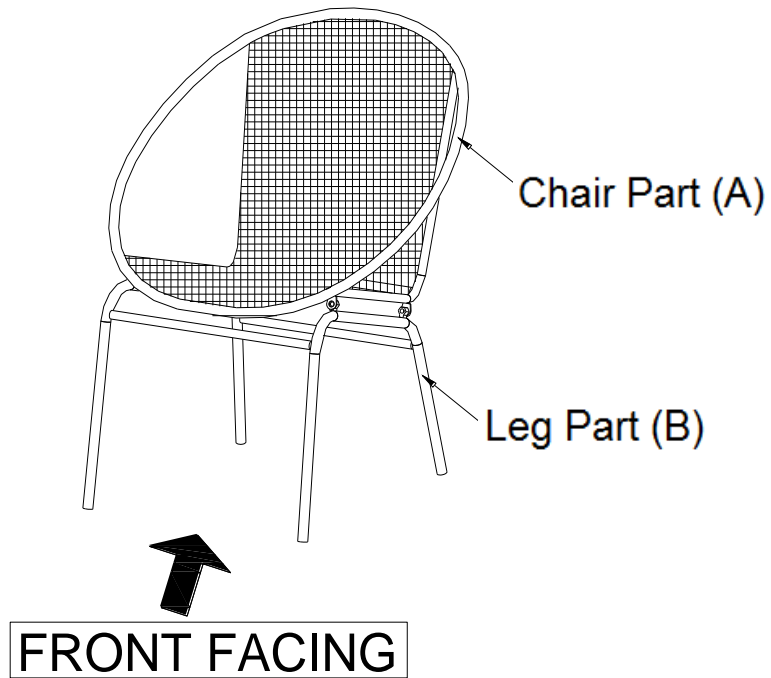

This Chair has multiple parts and may require up to 30 minutes to assemble. To give you an overview of the Chair parts, the above picture is to help you put the various parts into perspective. Please read through the instructions below to familiarise yourself with the parts and steps before assembly.

Step 1

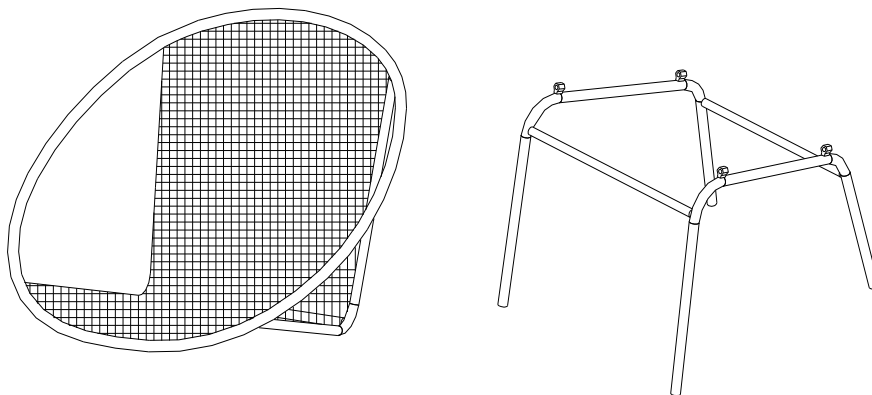

Unpack and place all parts on a clean, non-marring surface.

Step 2

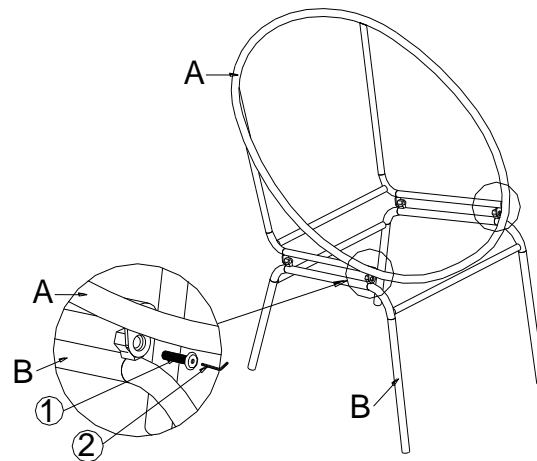

Align Chair Part(A) to Leg Part(B) as shown above.

Note: The higher side of the Leg Part(B) is the front side.

Attach Chair Part(A) to Leg Part(B) using Bolts(①) with Allen Key(②).

Do not fully tighten the Bolts.

Step 3

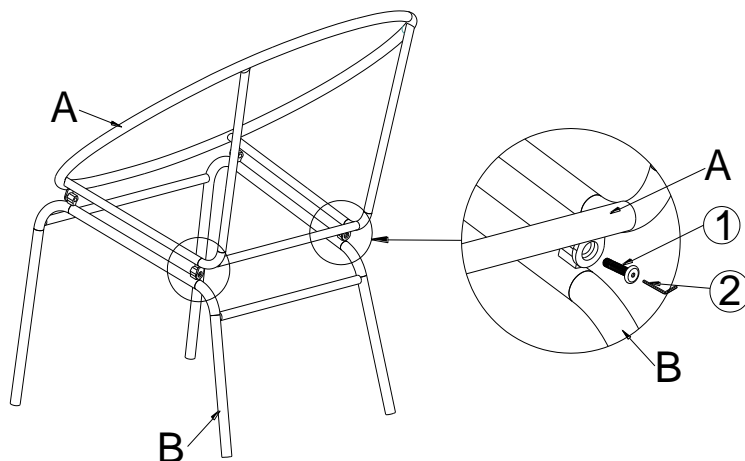

Attach Chair Part(A) to Leg Part(B) using Bolts(①) with Allen Key(②).

Place the Chair on a **LEVEL SURFACE**.

Inspect it and make sure all parts are adequately connected.

Gently and carefully sit onto the Chair

This will help to align all parts at all joints.

Then get off the Chair, and in a sequential manner, proceed to tighten all Bolts.

When tightening the Bolts, tighten sequentially.

DO NOT tighten any Bolt fully and then move on to the next one.

This may cause the frame to warp.

If there are still wobbles, loosen the Bolts and execute this same process.

Note: This step is done best with the assistance of a second adult.



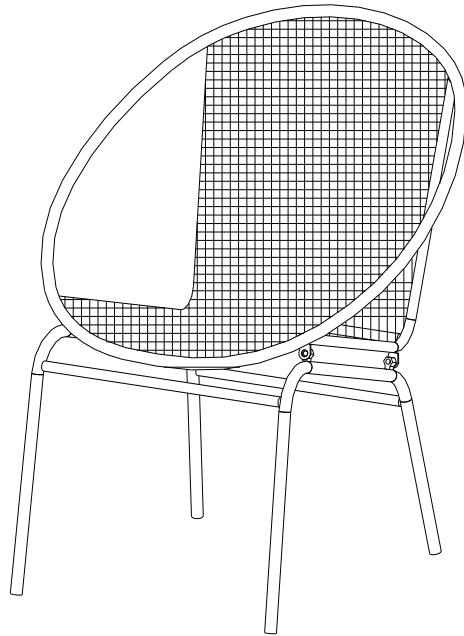

















Step 4



Your Chair is ready for use.

This Chair can only be used on the flat, level surface.

Care & Maintenance

-   ● Do not put hot items directly on furniture surface
 -   ● Do not clean furniture with harsh cleansers or polish.
 -   ● To obtain the longest lifespan of your outdoor products, minimizing exposure to direct sunlight is recommended.
 -   ● Children should not climb or jump on the furniture.
 -   ● Do not write on furniture without a padded barrier to protect the surface.
 -   ● To obtain the longest lifespan of your outdoor products, avoid extended and lengthy exposure to rain, snow, and direct sunshine. Whenever possible cover the product and /or place under patio or awnings.
 -   ● Not for commercial use. For residential use only .
 -   ● Stains may be removed with mild soap solution and damp cloth.
 -   ● Keep away from sources of ignition.
-
-   ● Dust and pick-up spills using a clean, non-colored, lint-free cloth.