

1444869COM

Fireplace TV stand



Date of Purchase ___ / ___ / ___
Lot Number:

B341444869COM00GO

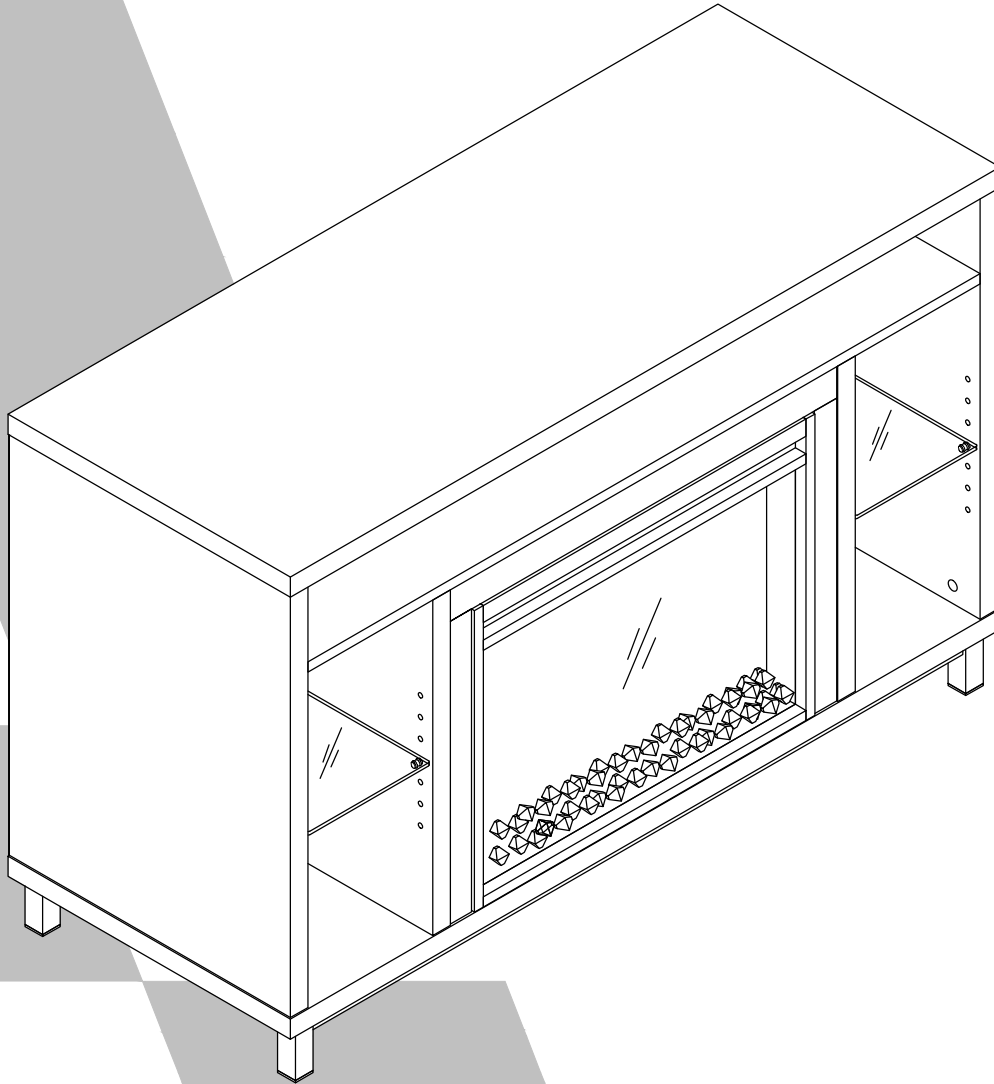

THIS INSTRUCTION BOOKLET CONTAINS **IMPORTANT** SAFETY INFORMATION. PLEASE READ AND KEEP FOR FUTURE REFERENCE.

Do Not Return This Product!

Contact our customer service team for help first.

Call: 1-800-489-3351 (toll free)

Monday-Friday 9am - 5pm CST

Visit: www.ameriwoodhome.com

WARNING

- Unit can tip over causing severe injury or death.
- Anchor unit to stud in wall (if instructed to).
- Do Not allow children to climb on unit.
- Put heavy items on lower shelves or drawers.

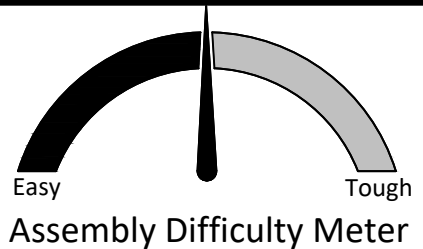

Follow Ameriwood Home



Contact Us!

Do NOT return this product!

Contact our friendly customer service team first for help.

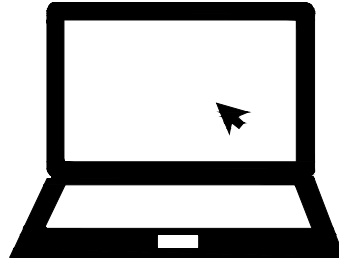
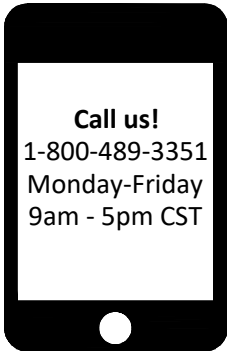

Visit ameriwoodhome.com

Assembly Tips



Helpful Hints

PEOPLE NEEDED FOR ASSEMBLY: 2

ESTIMATED ASSEMBLY TIME: 1 HOUR

- Open your item in the area you plan to keep it to avoid excessive heavy lifting.
- Identify, sort and count the parts before attempting assembly.
- Compression dowels are lightly tapped in with a hammer.
- Slides are labeled with a **R** (right) and **L** (left) for proper placement.
- Make sure to always face the point on the top of the Cam Lock towards the outer edge.
- Use all the nails provided for the back panel and spread them out equally.
- Back panel must be used to make sure your unit is sturdy.
- Do NOT use harsh chemicals or abrasive cleaners on this item.
- Never push, pull, or drag your furniture.

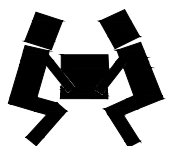
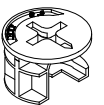
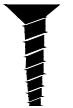

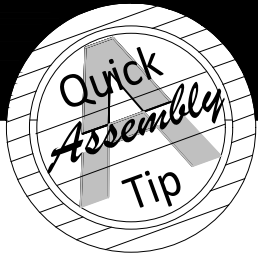

Before You Start

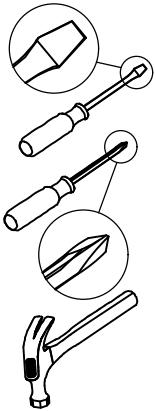

- ✓ Read through each step carefully and follow the proper order
- ✓ Separate and count all your parts and hardware
- ✓ Give yourself enough room for the assembly process
- ✓ Have the following tools: Flat Head Screwdriver, #2 Phillips Head Screwdriver and Hammer
- ✓ Caution: If using a power drill or power screwdriver for screwing, please be aware to slow down and stop when screw is tight. Failure to do so may result in stripping the screw.

Cam Lock Fastening System

This Cam Lock Fastening System will be used throughout the assembly process.

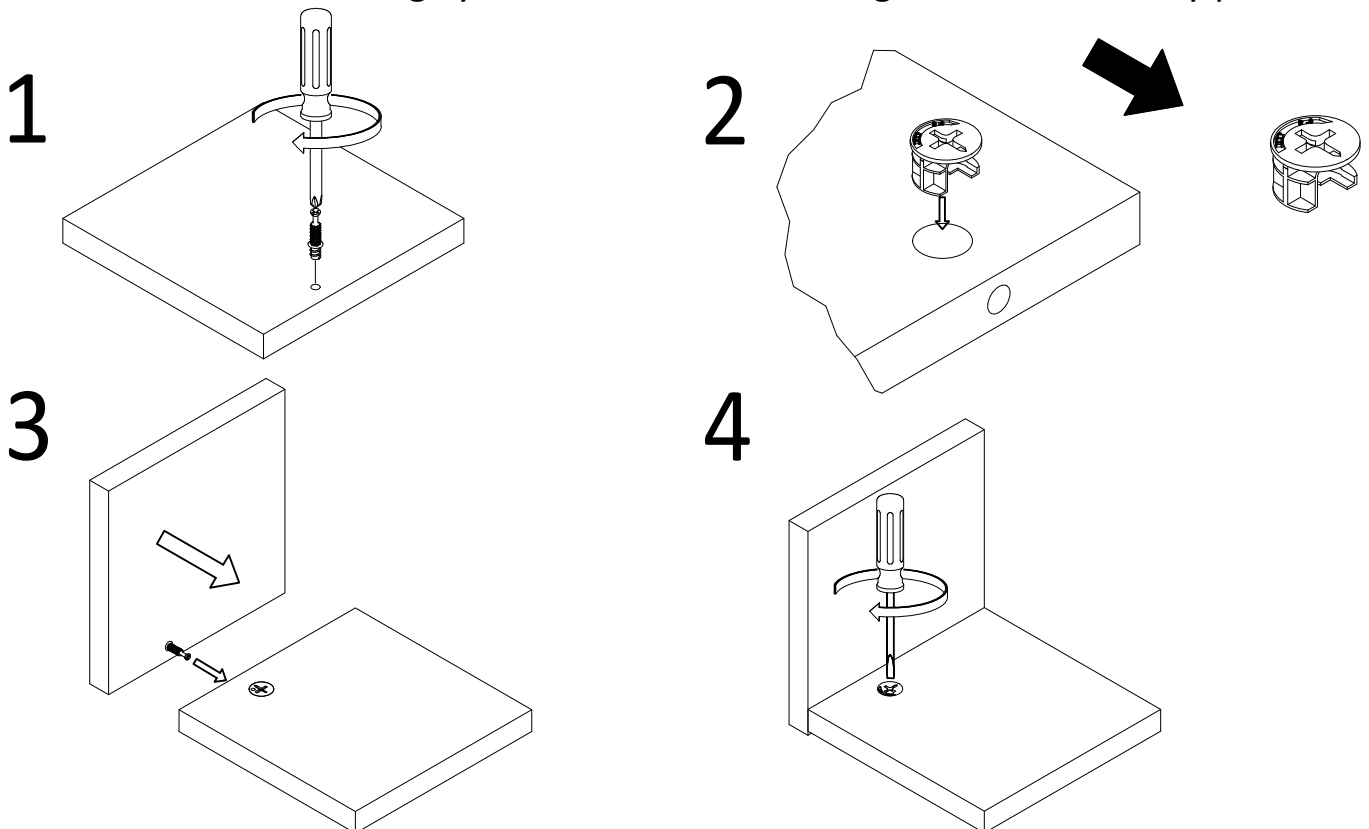

Board Identification

Not actual size

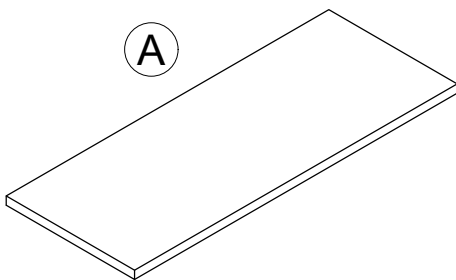

A
TOP PANEL
T1444869010GO
QTY: 1 PC

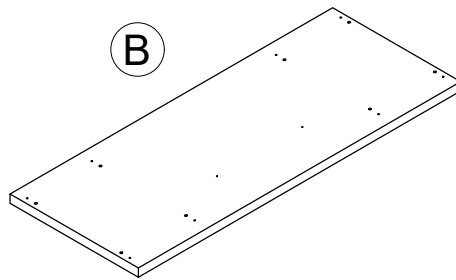

B
BOTTOM PANEL
T1444869020GO
QTY: 1 PC

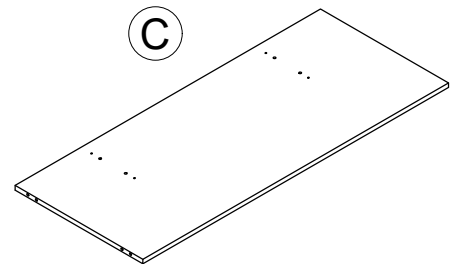

C
FIXED SHELF
T1444869030GO
QTY: 1 PC

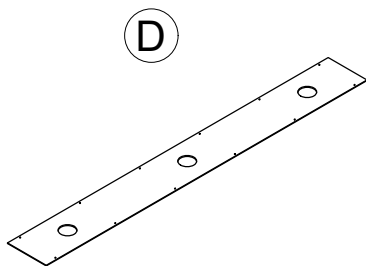

D
UPPER BACK PANEL
T1444869040GO
QTY: 1 PC

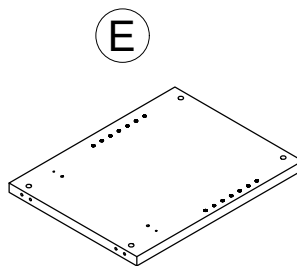

E
LEFT SIDE PANEL
T1444869050GO
QTY: 1 PC

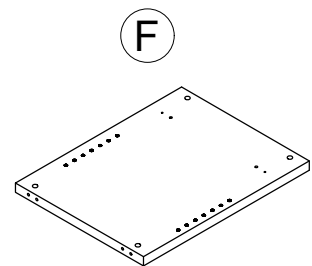

F
RIGHT SIDE PANEL
T1444869060GO
QTY: 1 PC

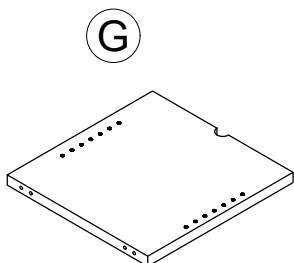

G
LEFT MIDDLE PANEL
T1444869070GO
QTY: 1 PC

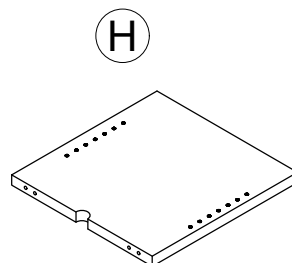

H
RIGHT MIDDLE PANEL
T1444869080GO
QTY: 1 PC

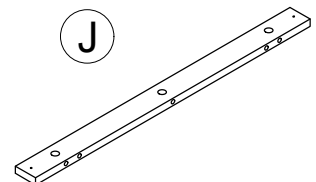

J
UPPER RAIL
T1444869090GO
QTY: 1 PC

Board Identification

Not actual size

(K)

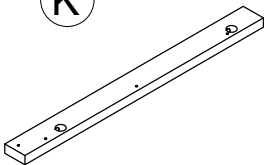

LEFT RAIL
T1444869100GO
QTY: 1 PC

(L)

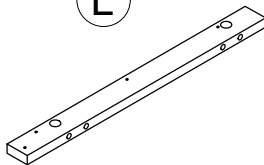

RIGHT RAIL
T1444869110GO
QTY: 1 PC

(M)

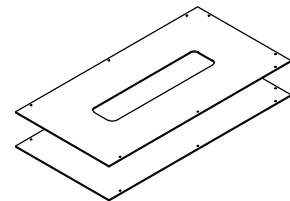

BACK PANEL
T1444869120GO
QTY: 2 PCS

(N)

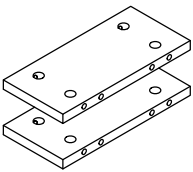

UPPER MIDDLE PANEL
T1444869130GO
QTY: 2 PCS

(P)

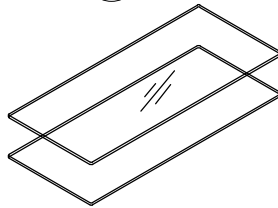

GLASS SHELF
T1444869140GO
QTY: 2 PCS

(Q)

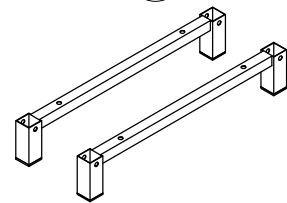

SIDE FRAME TUBE
T1444869150GO
QTY: 2 PCS

(R)

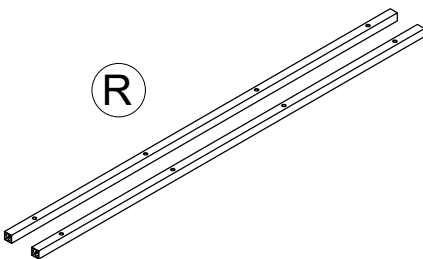

SUPPORTING PIPE
T1444869160GO
QTY: 2 PCS

(S)

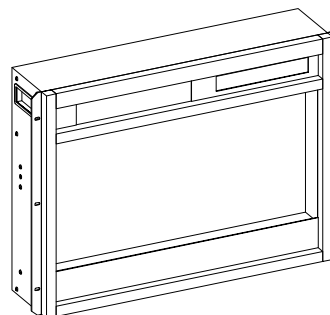

FIREPLACE
FA23V60L-C8
QTY: 1PC

Remote control	FA23V60L-C801
Acrylic crystal	FA23V60L-C802
LED light bar (2)	FA23V60L-C803

Board Identification

Not actual size

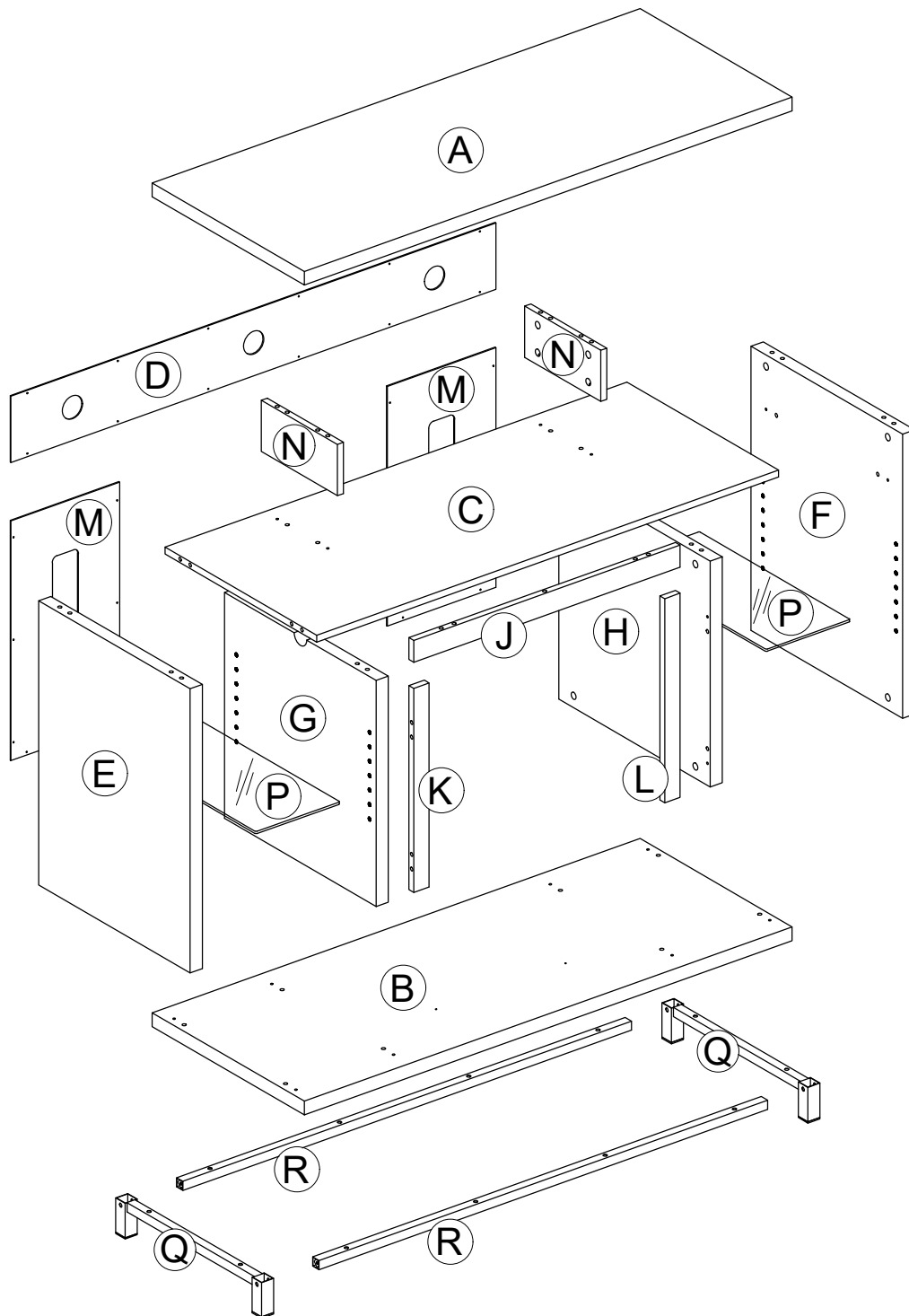

Part List

Actual Size

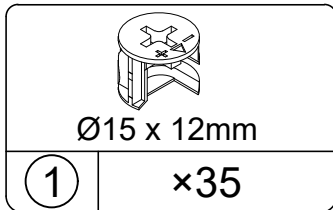

CAM LOCK
TGO2101

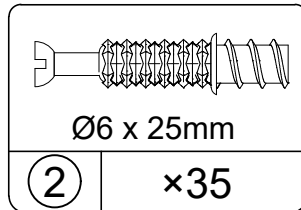

CAM BOLT
TGO2001

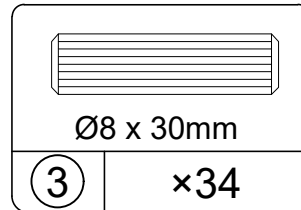

WOOD DOWEL
TGO2900

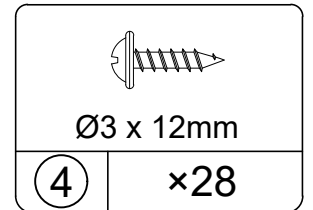

SCREW
TGO1301W

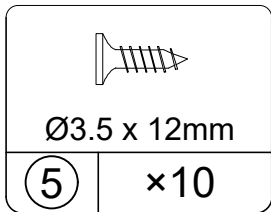

SCREW
TGO1007

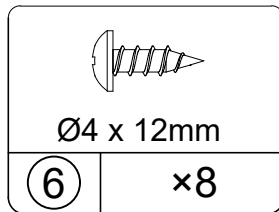

SCREW
TGO1323

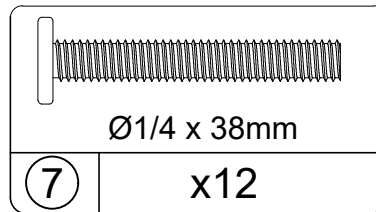

BOLT
TGO1630W

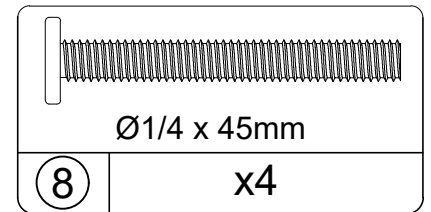

BOLT
TGO1623W

No Actual Size

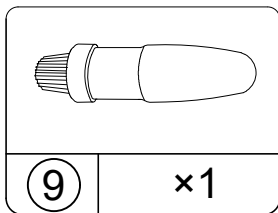

GLUE
TGO9001

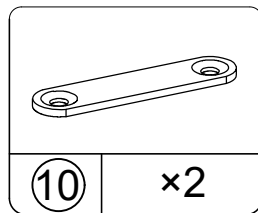

METAL PLATE
TGO3525

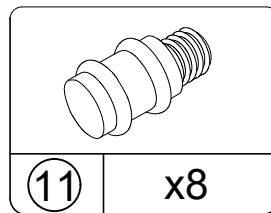

SHELF SUPPORT
TGO2811

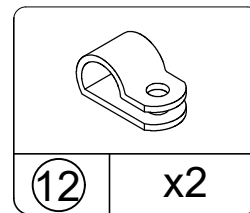

WIRE CLIP
TGO9093

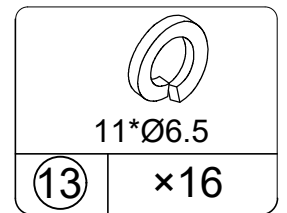

SPRING WASHER
TGO4606W

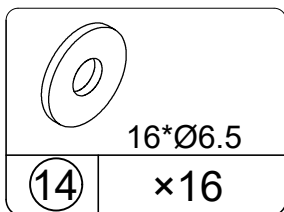

WASHER
TGO4604W

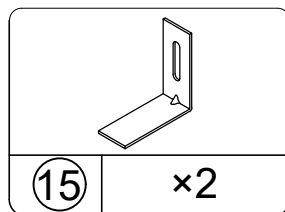

ANGLE BRACKET
TGO3539

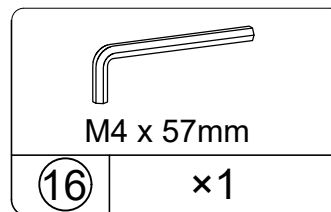

HEX KEY
TGO7001

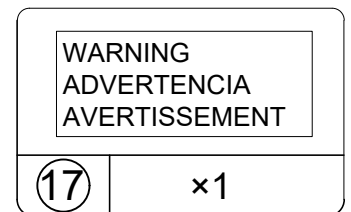

WARNING LABEL
TGO6594

STEP 1

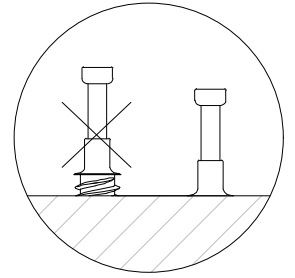
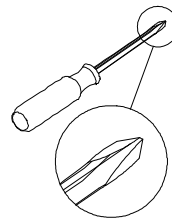
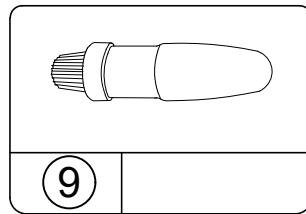
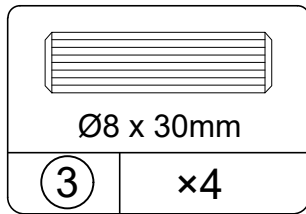
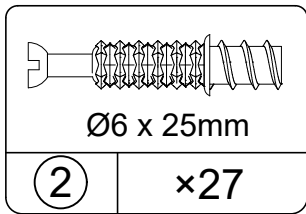

1.1 Attach cam bolt (2) into (A), (B) and (C) as illustrated.

1.2 Insert (3) into (C) as illustrated.

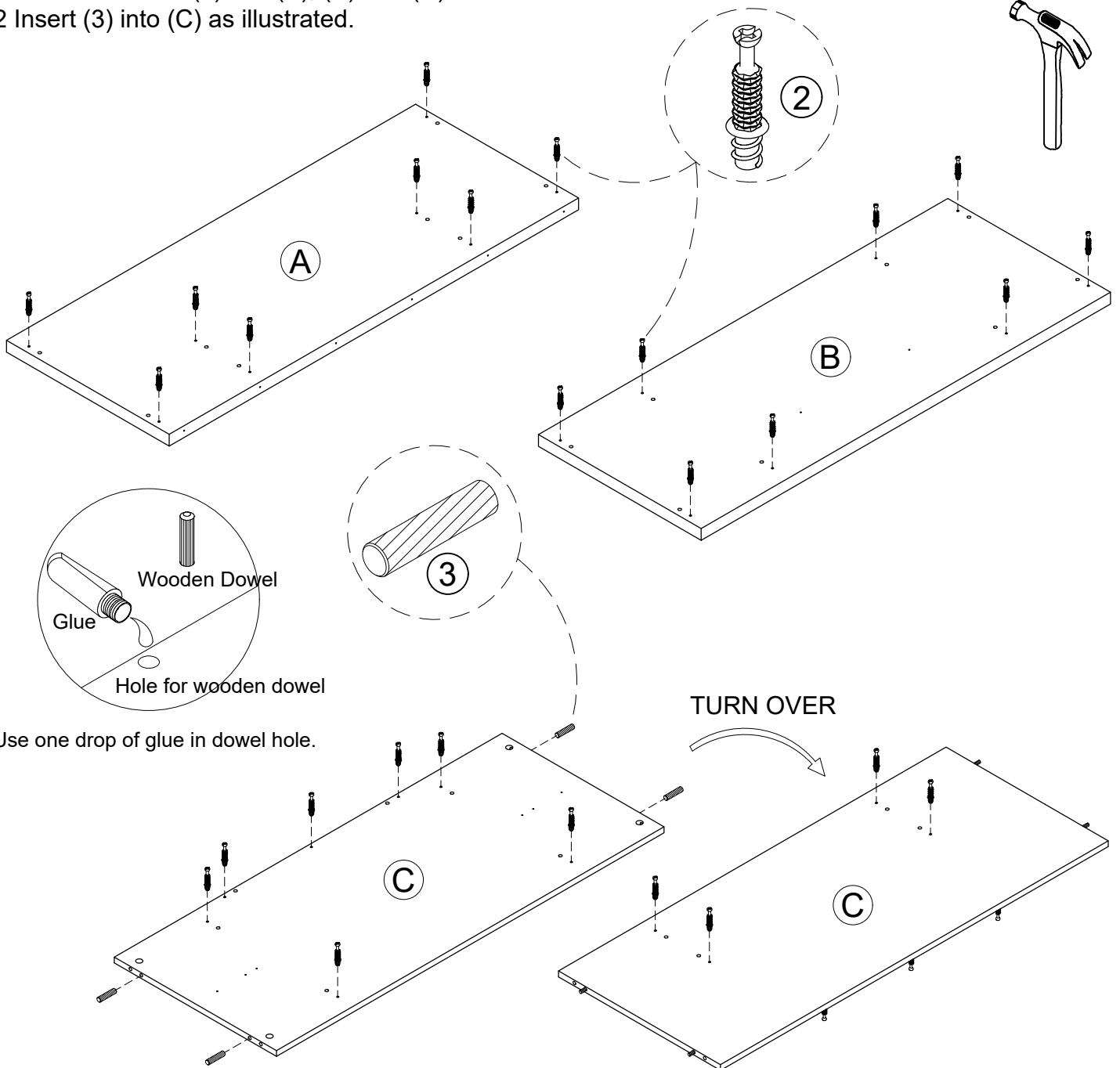

STEP 2

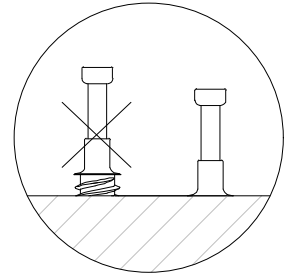
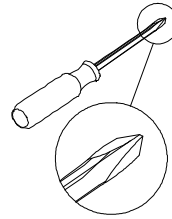
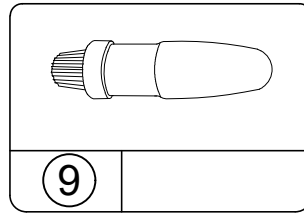
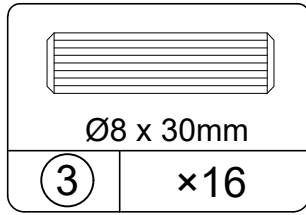
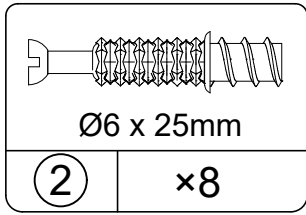

- 2.1 Attach cam bolt (2) into (E), (F), (G) and (H) as illustrated.
2.2 Insert (3) into (E), (F), (G) and (H) as illustrated.

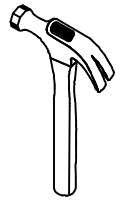
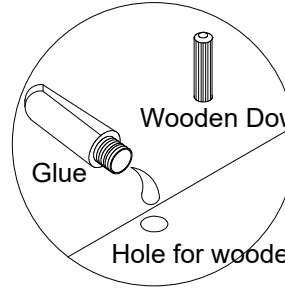

Use one drop of glue in dowel hole.

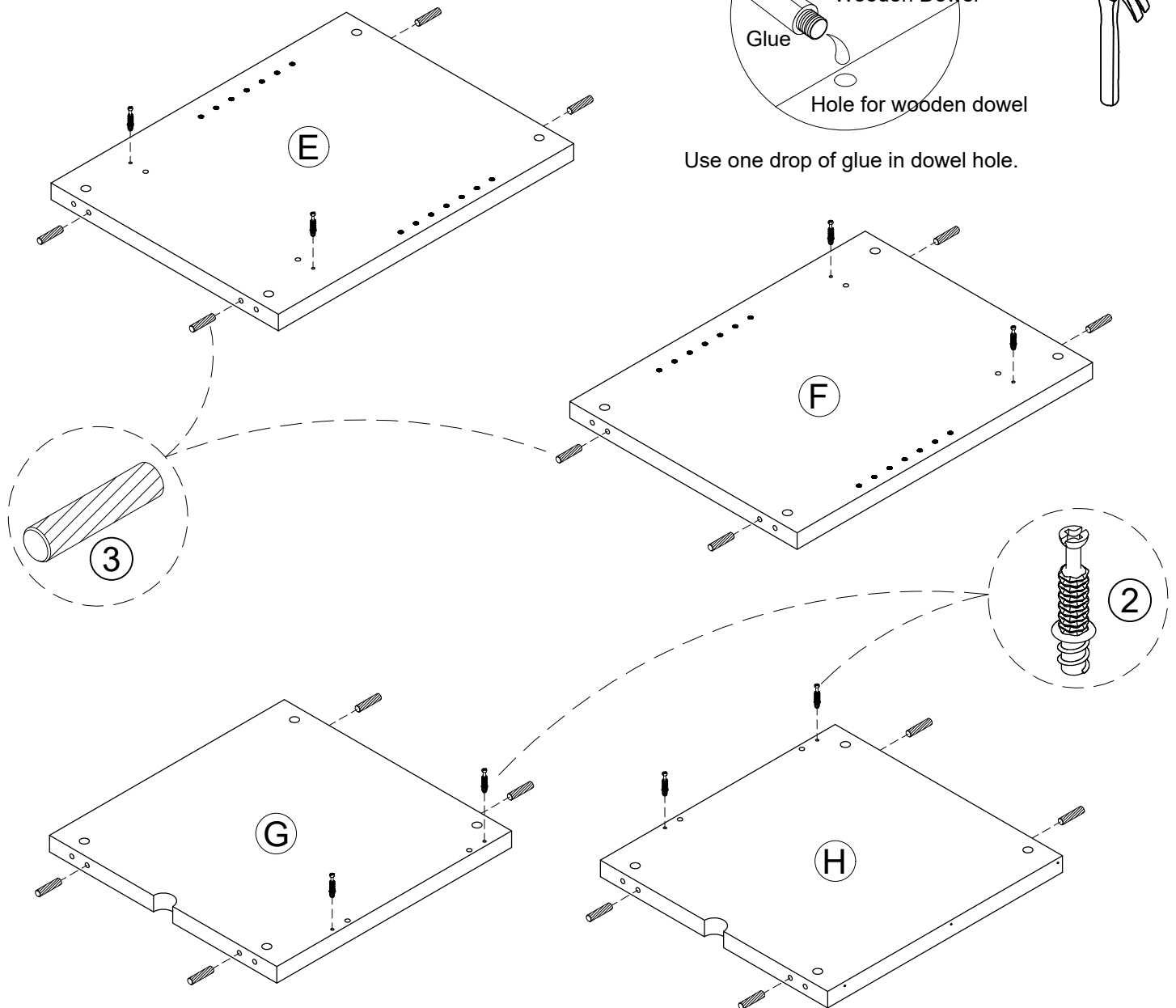

STEP 3

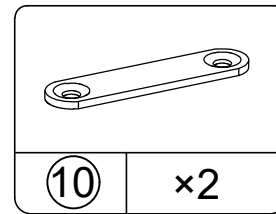
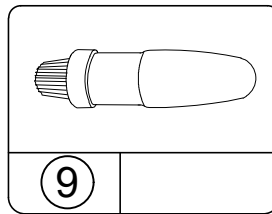
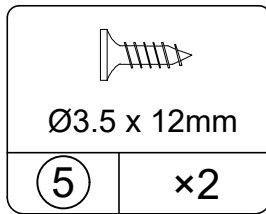
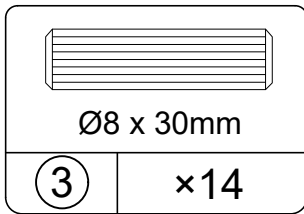

3.1 Insert (3) into (N) x 2, (J), (K) and (L) as illustrated.

3.2 Attach (10) into (J) with (5) as illustrated.

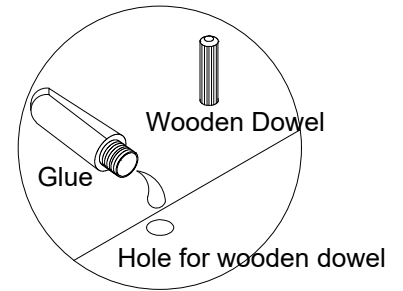

Use one drop of glue in dowel hole.

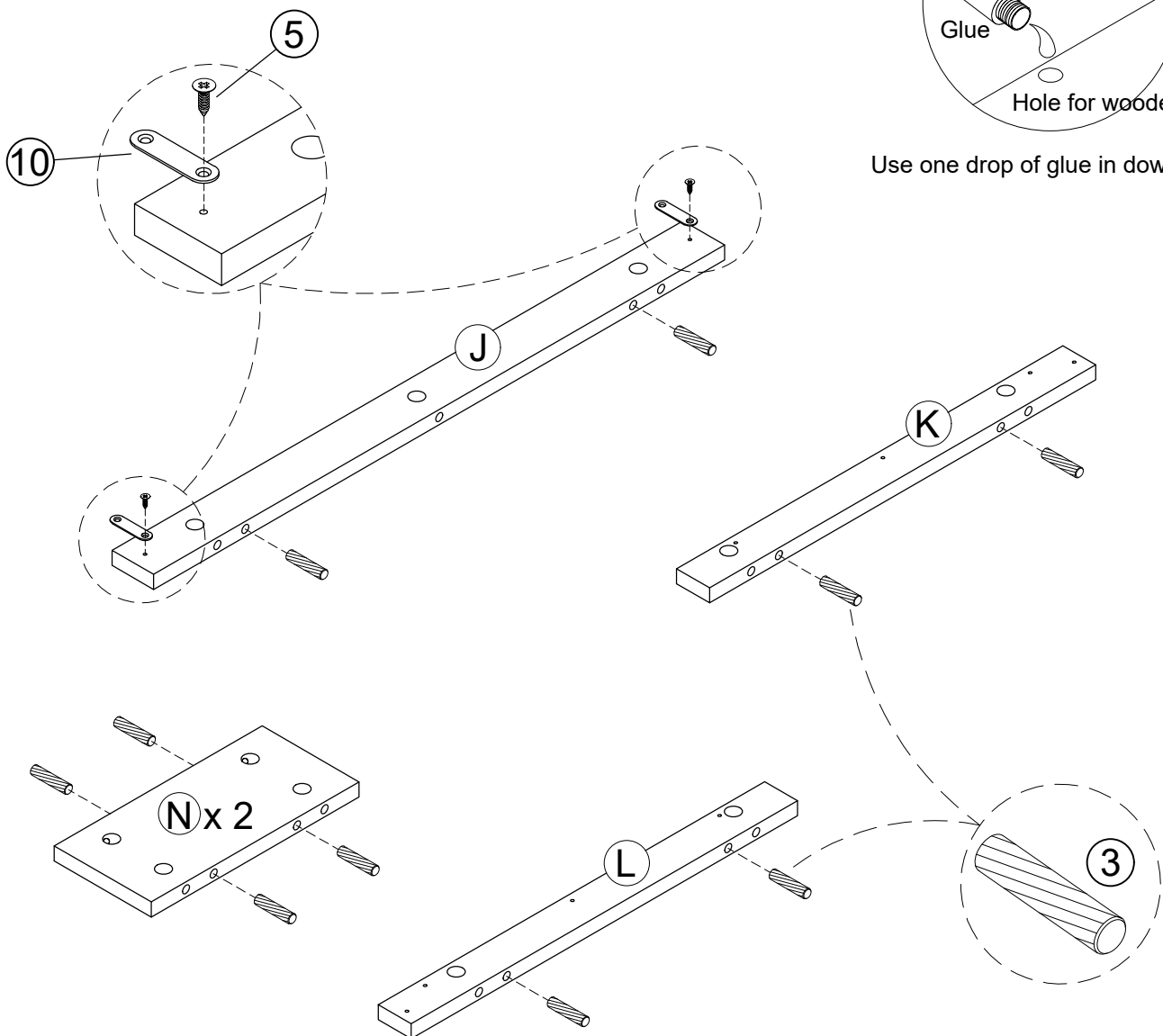

STEP 4

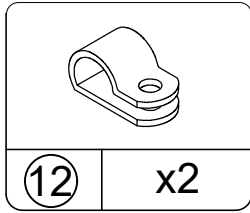
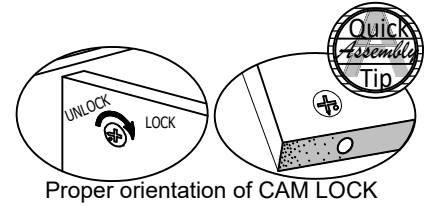
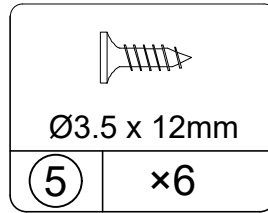
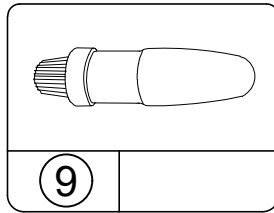
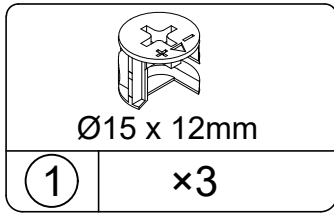

- 4.1 Attach (J) to (C) with (1) as illustrated.
- 4.2 Attach LED light bar into (C) with (5) as illustrated.
- 4.2 Attach (12) into (C) with (5) as illustrated.

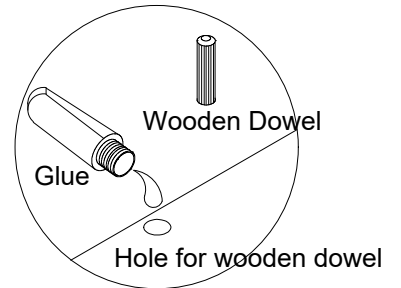
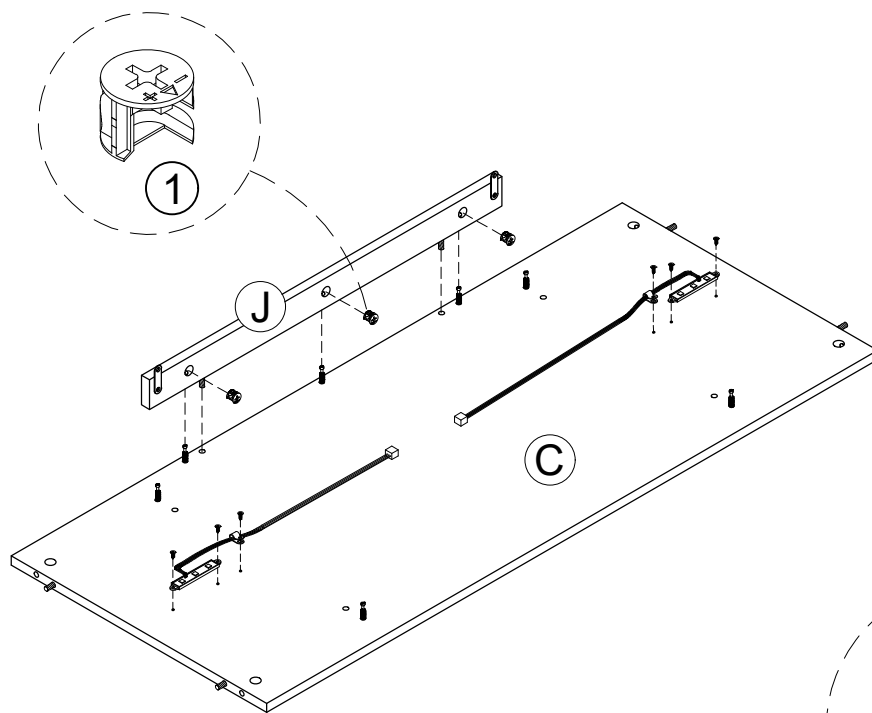
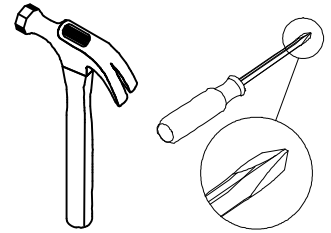

Use one drop of glue in dowel hole.

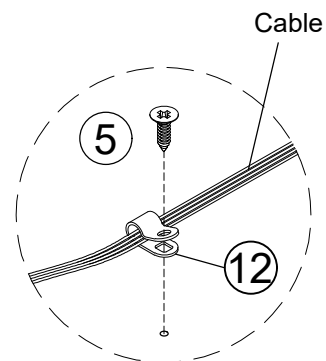
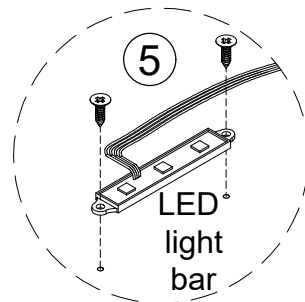

STEP 5

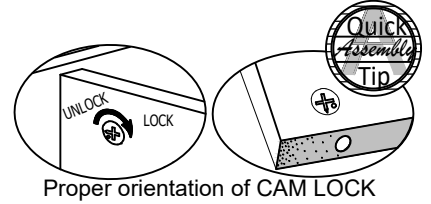
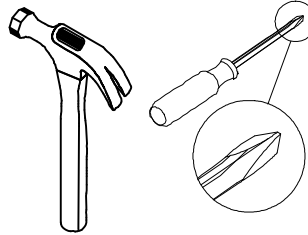
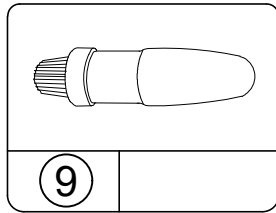
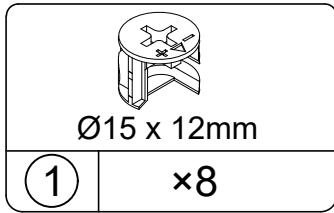

- 5.1 Attach (K) into (G) with (1) as illustrated.
- 5.2 Attach (L) into (H) with (1) as illustrated.
- 5.3 Attach (G), (H) into (C) with (1) as illustrated.

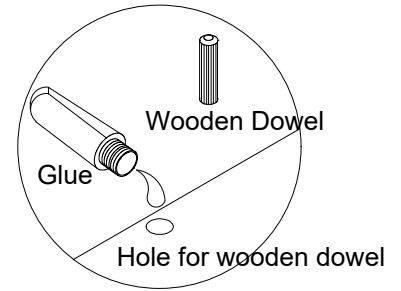

Use one drop of glue in dowel hole.

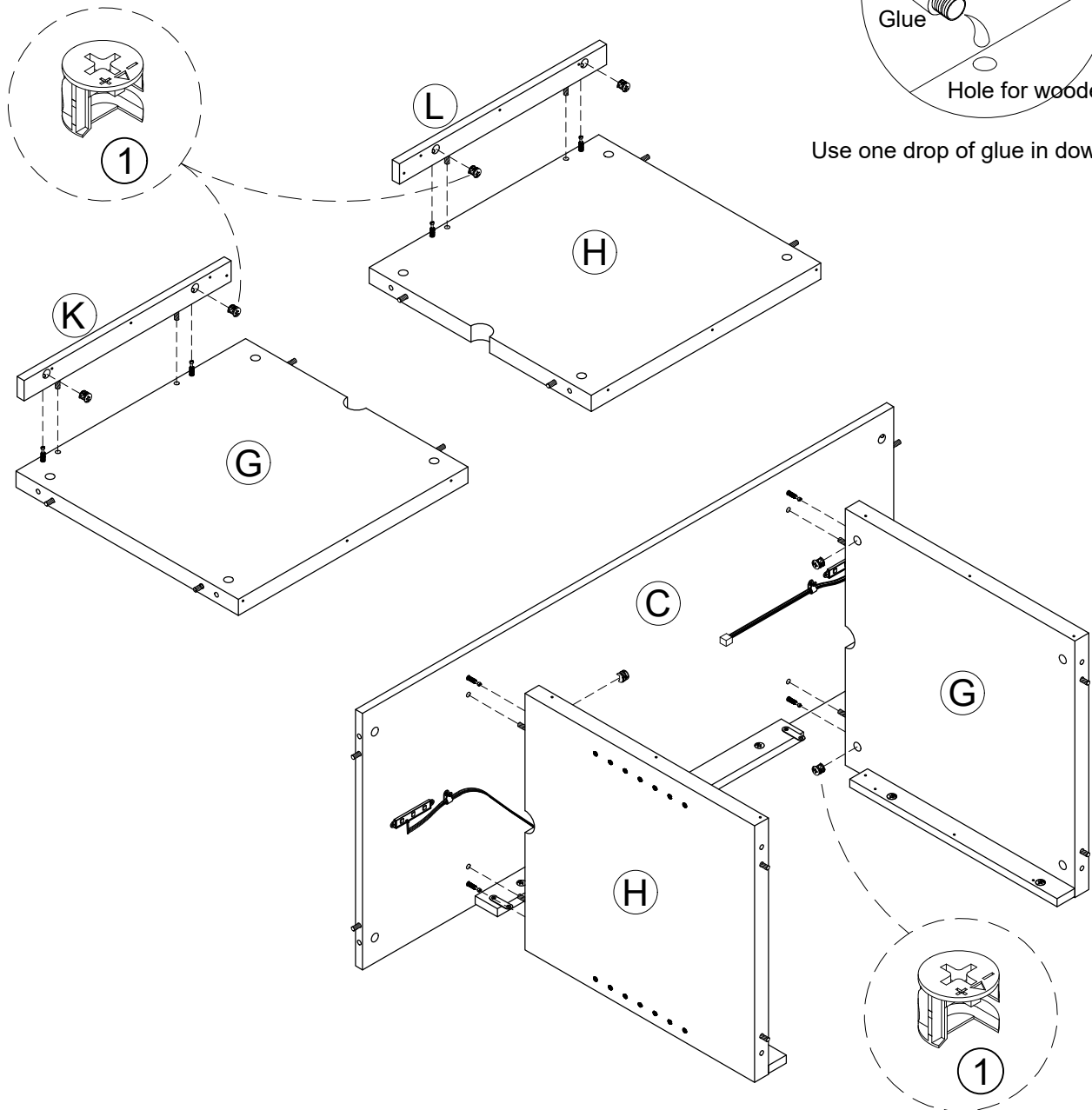

STEP 6

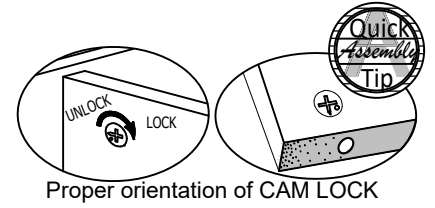
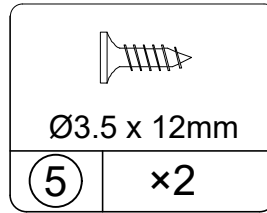
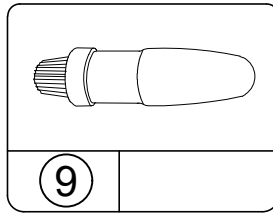
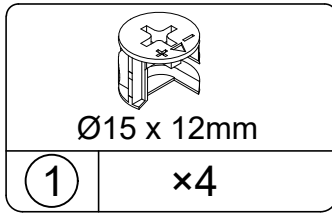

- 6.1 Attach (E), (F) into (C) with (1) as illustrated.
6.2 Attach (K), (L) into (10) with (5) as illustrated.

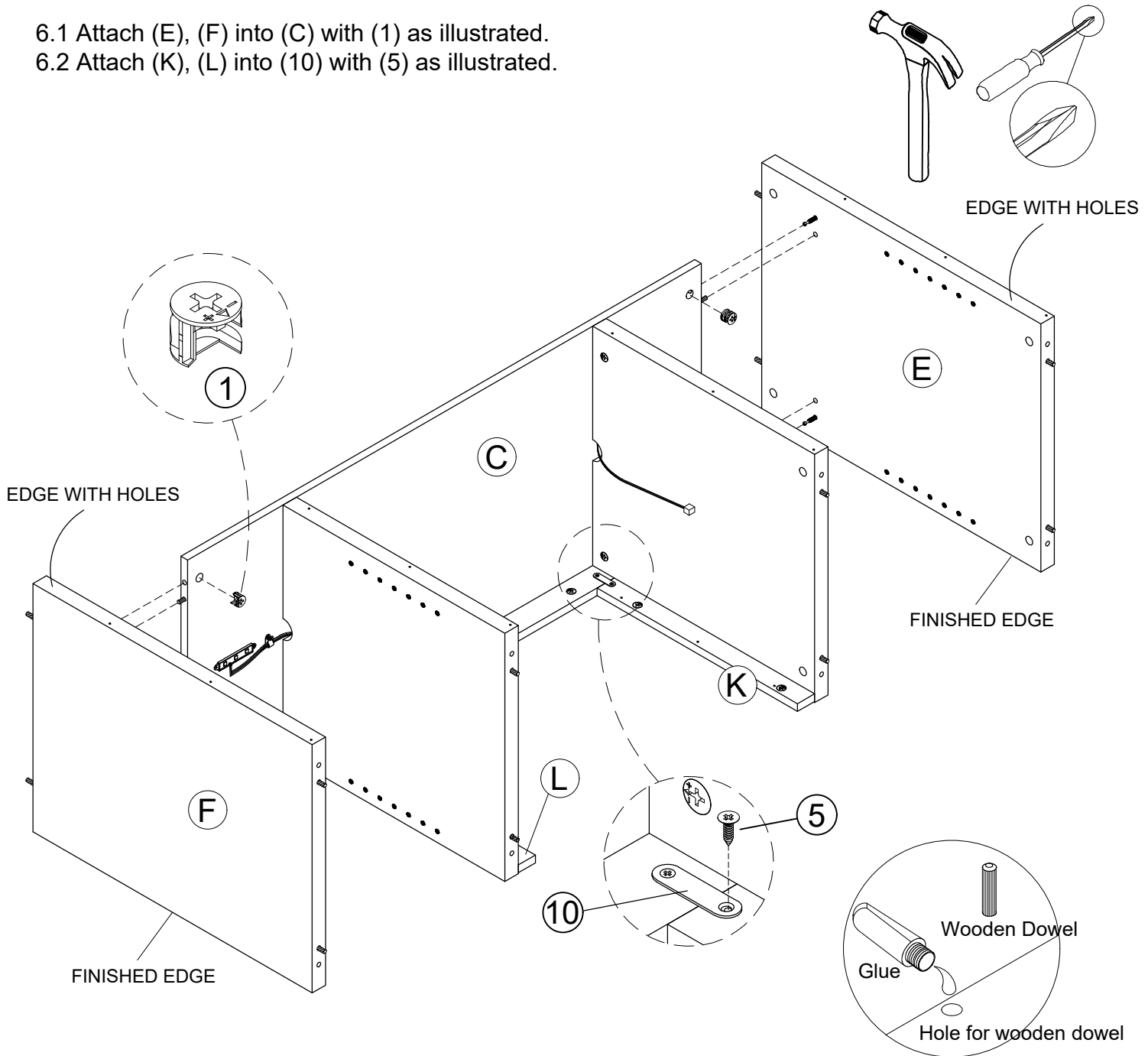

Use one drop of glue in dowel hole.

STEP 7

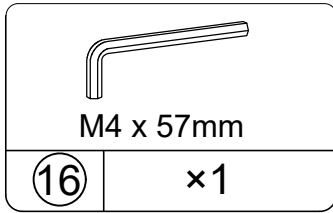
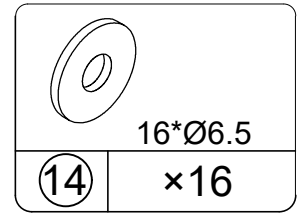
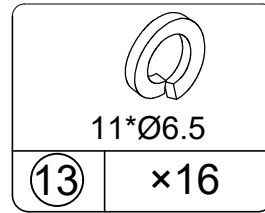
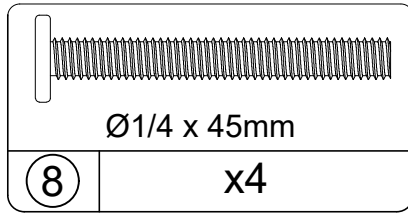
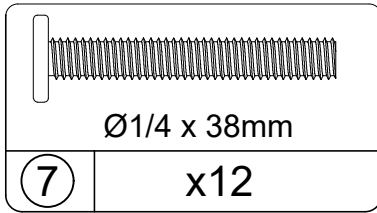

- 7.1 Attach (Q) into (B) with (7), (13) and (14) as illustrated.
- 7.2 Attach (R) into (B) with (7), (13) and (14) as illustrated.
- 7.3 Attach (R) into (Q) with (8), (13) and (14) as illustrated.

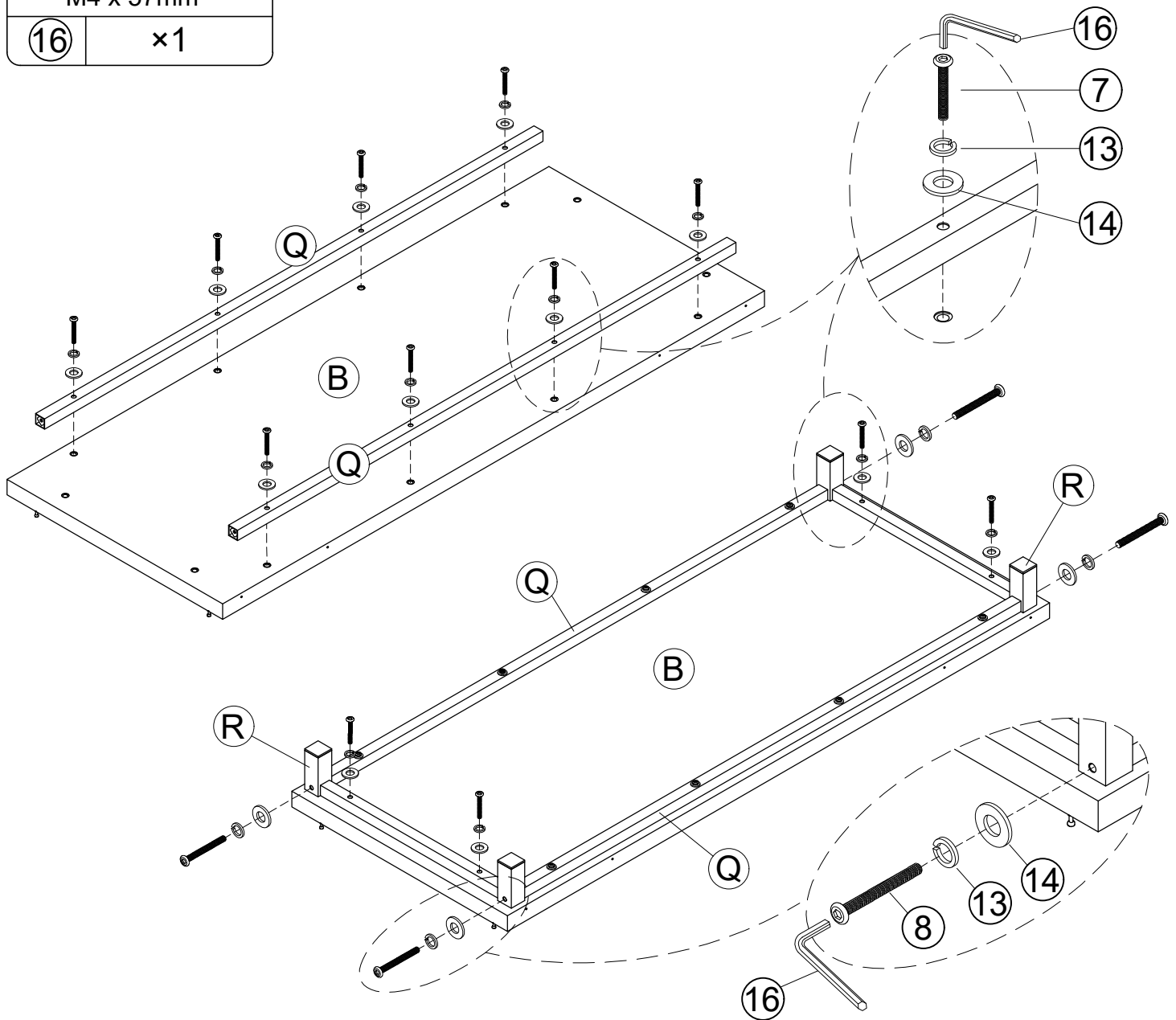

STEP 8

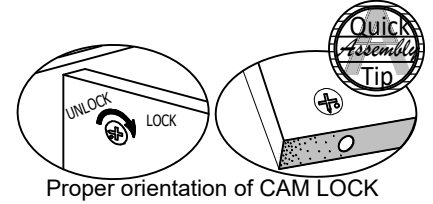
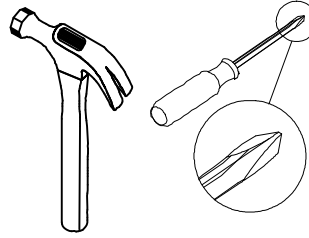
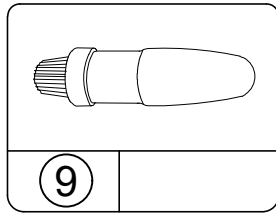
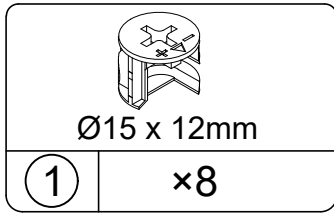

8.1 Attach (B) into (E), (F), (G) and (H) with (1) as illustrated.

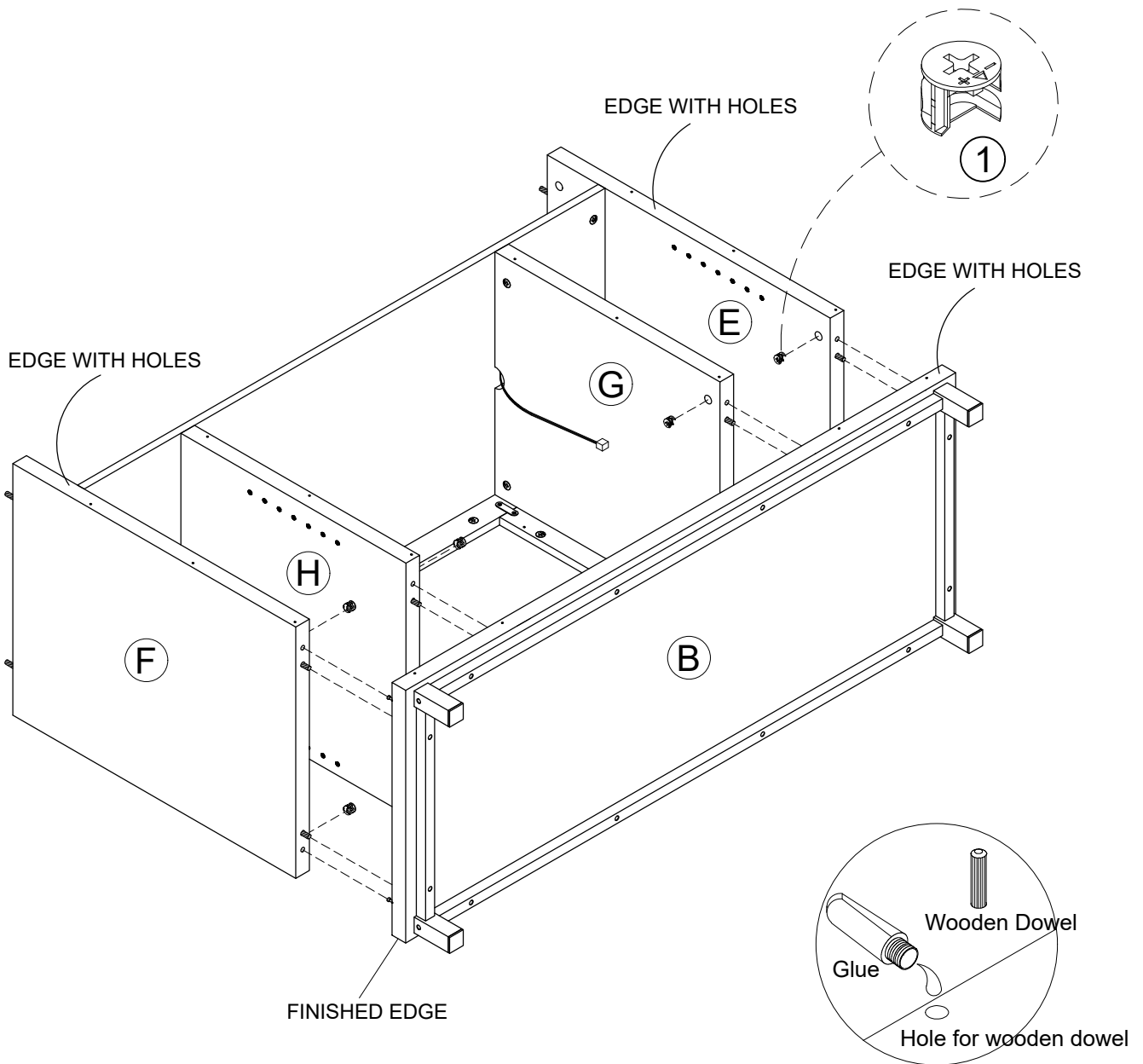

Use one drop of glue in dowel hole.

STEP 9

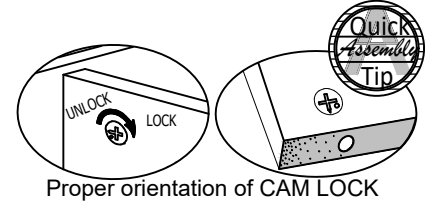
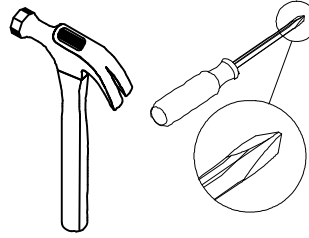
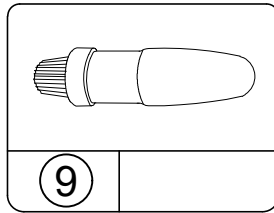
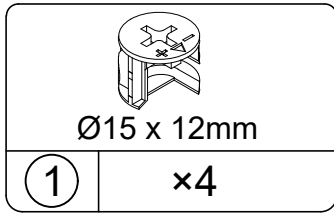

9.1 Attach (N) x 2 into (C) with (1) as illustrated.

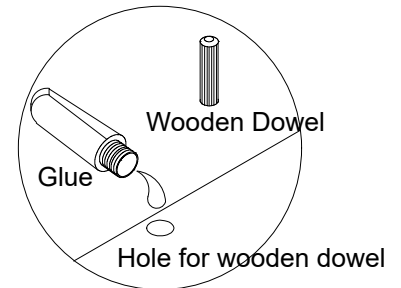

Use one drop of glue in dowel hole.

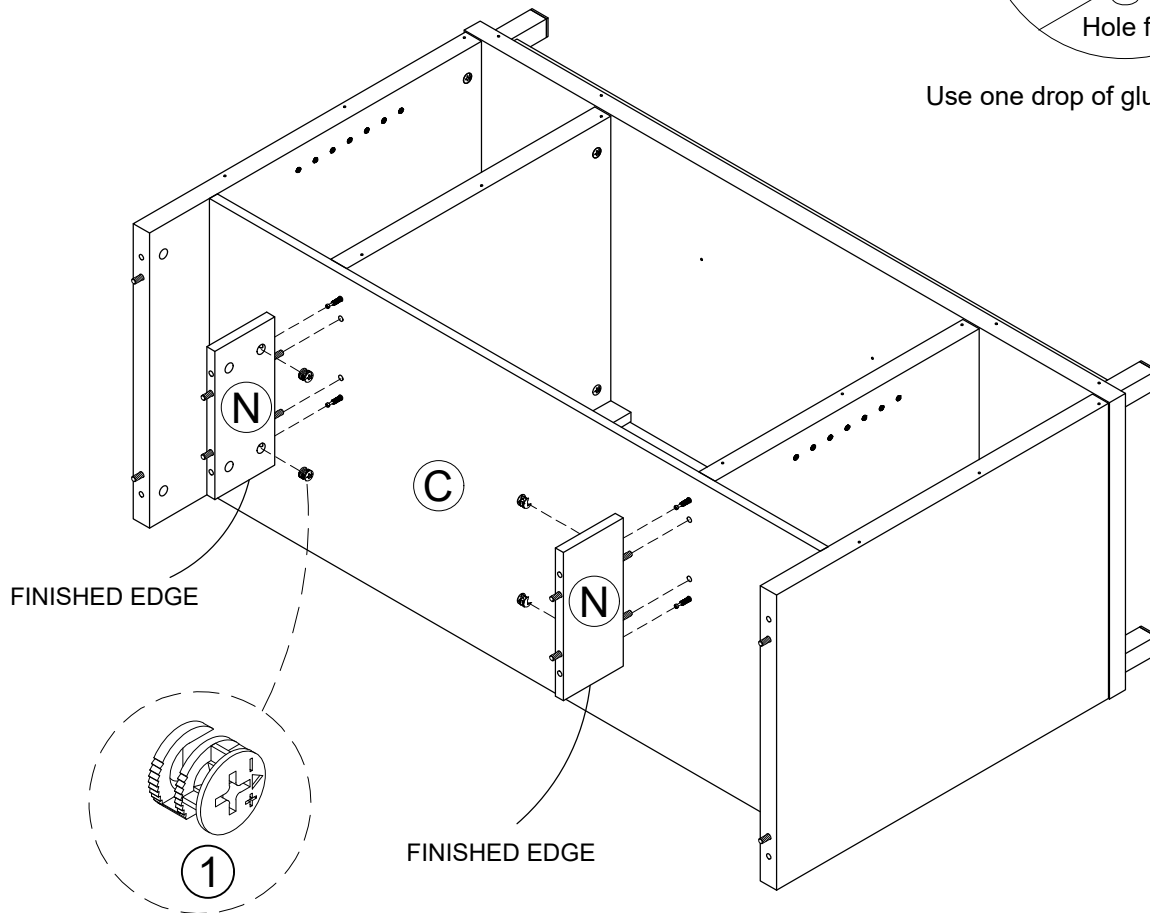

STEP 10

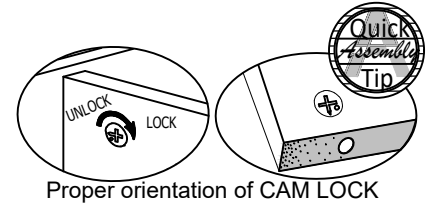
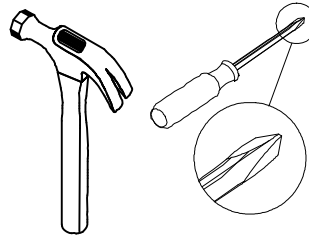
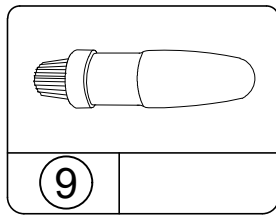
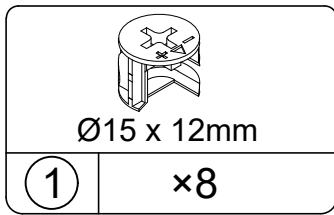

10.1 Attach (A) into (E), (F) and (N) with (1) as illustrated.

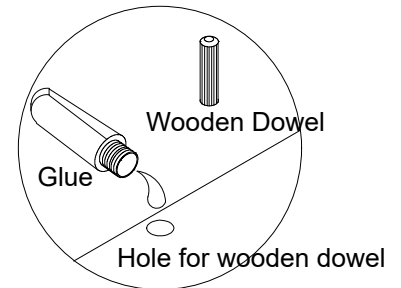

Use one drop of glue in dowel hole.

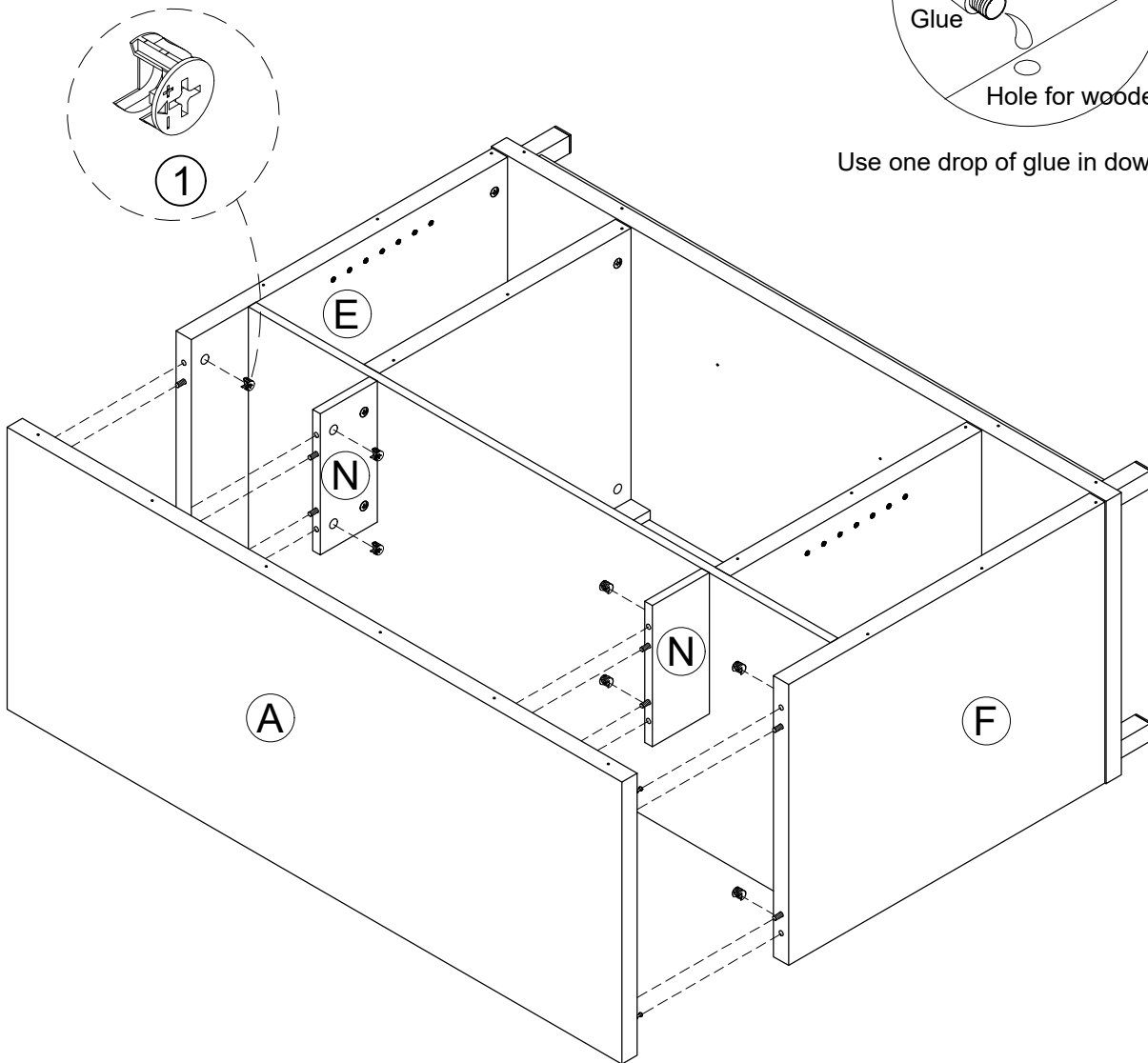

STEP 11

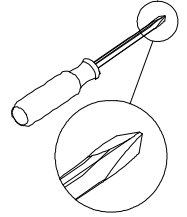
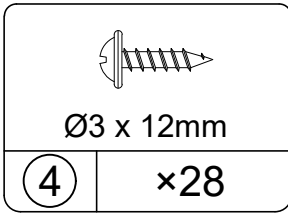

11.1 Attach (D) into (A), (C) with (4) as illustrated.

11.2 Attach (M) x 2 into (B) (E), (F), (G) and (H) with (4) as illustrated.

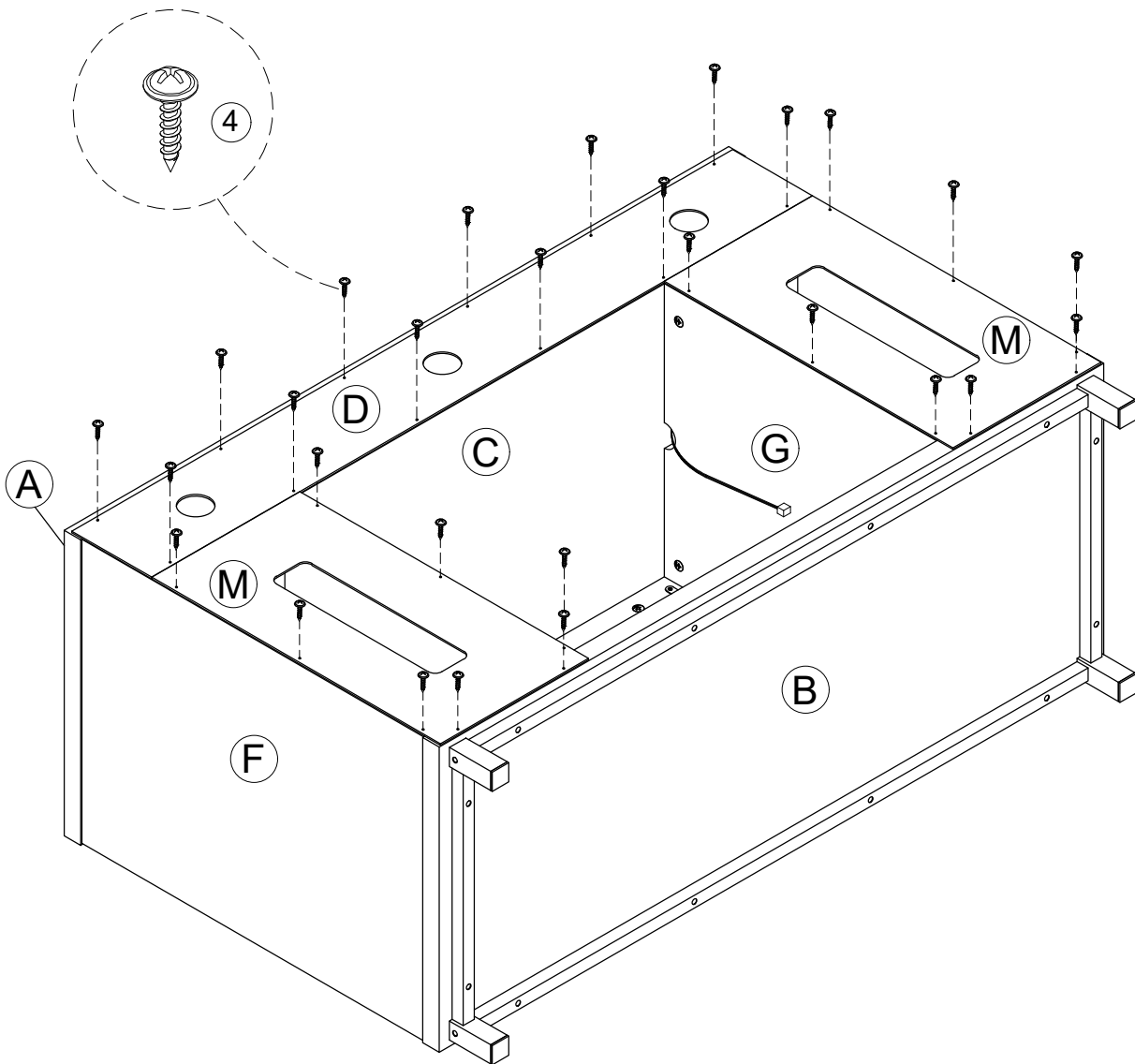

STEP 12

- 12.1 Insert fireplace into TV STAND as illustrated.
- 12.2 Insert the LED power cord to fireplace as shown below.

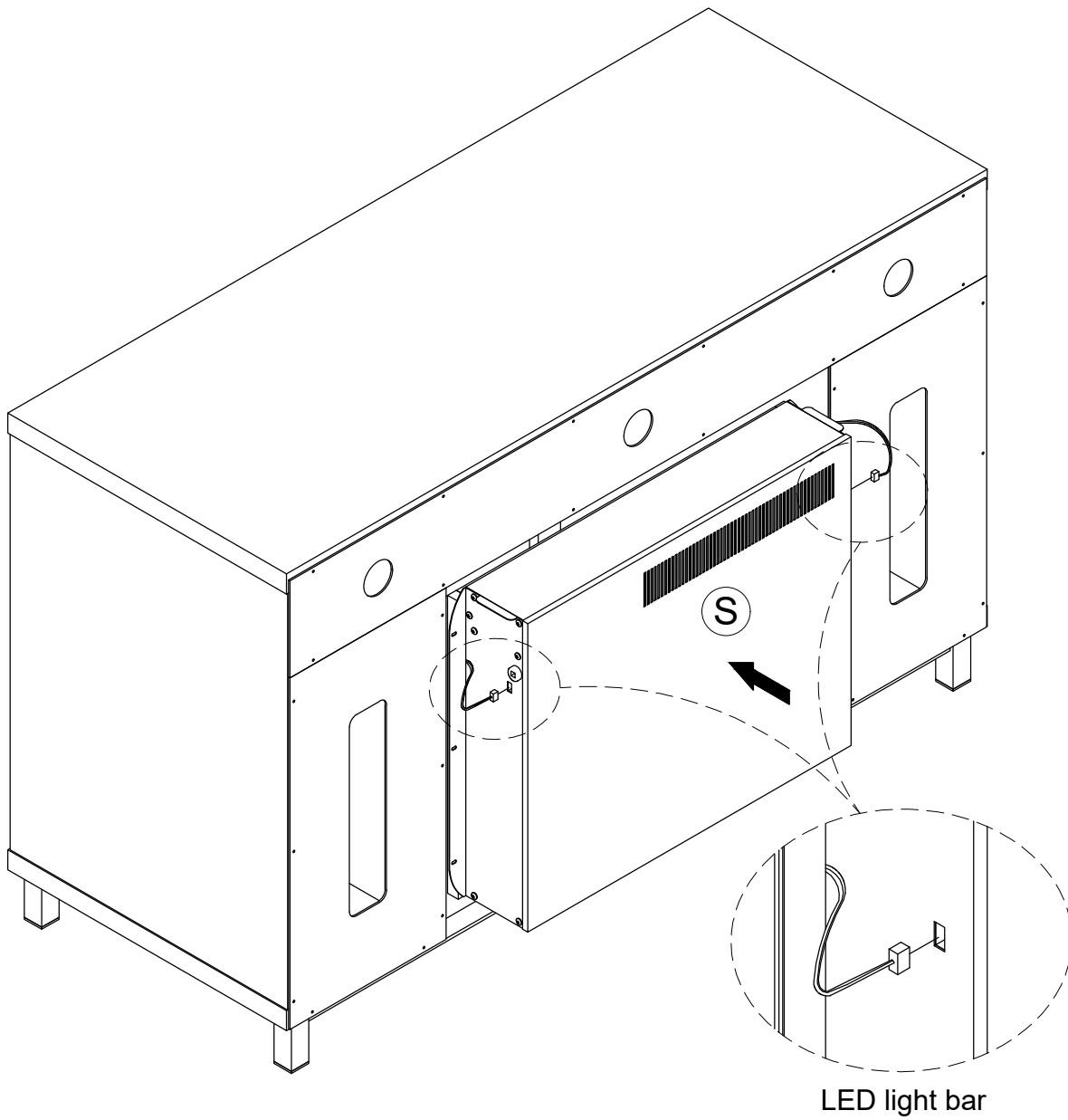
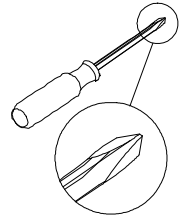

STEP 13

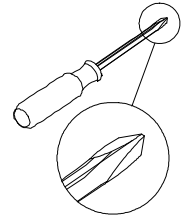
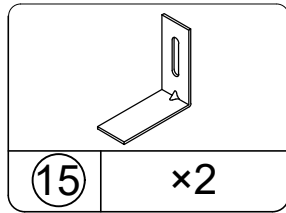
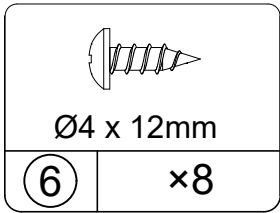

- 13.1 Attach (S) into (K), (L) with (6) as illustrated.
- 13.2 Attach (15) into (B) with (6) as illustrated.

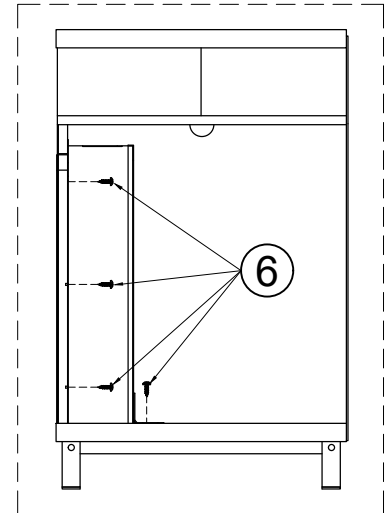

(SIDE VIEW)

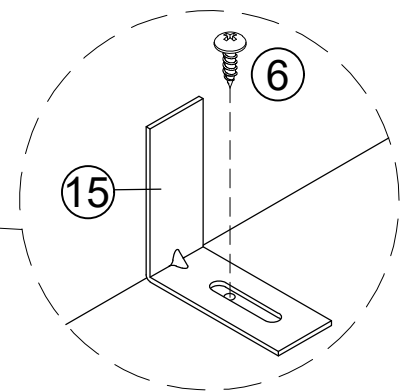
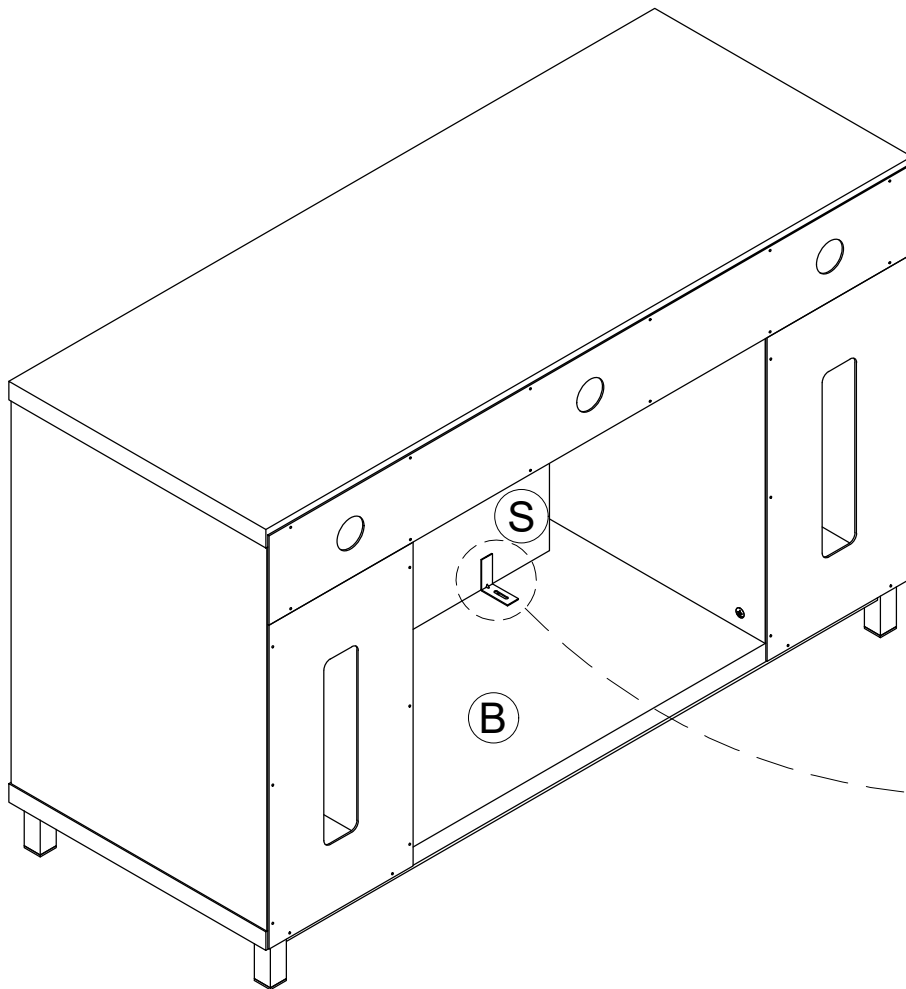

STEP 14

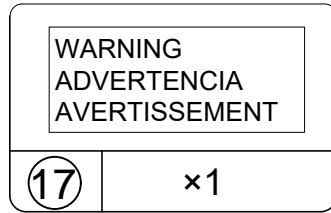
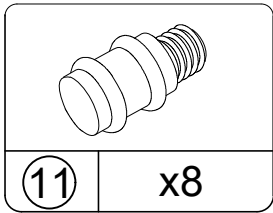

14.1 Attach (11) into (E), (F), (G), (H) as illustrated.

14.2 Put (P) on shelf pin as illustrated.

14.3 Apply Warning label (17) to top surface so that you so you'll always have the model's weight and TV size limits.

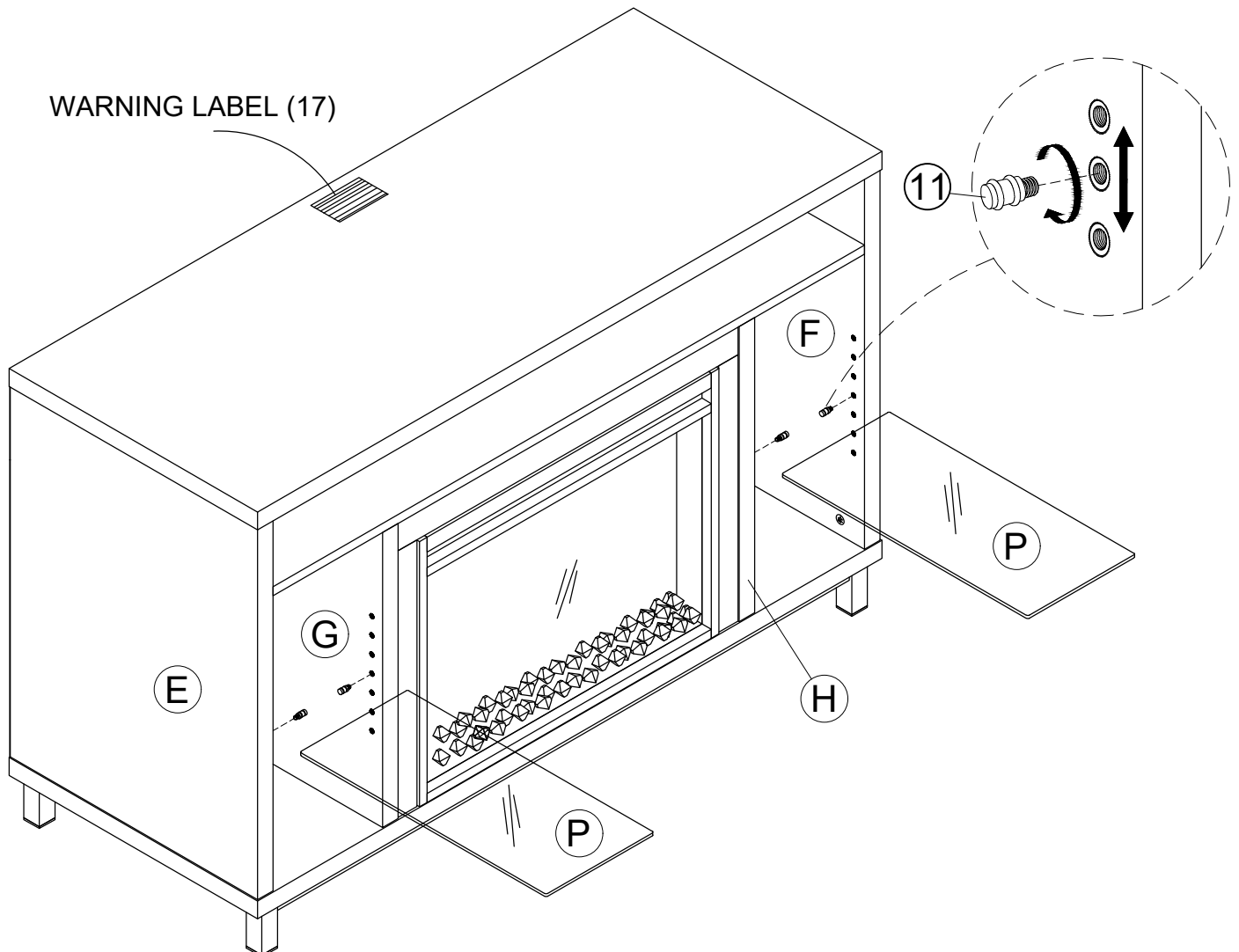

STEP 15

BEFORE CONNECTING THE UNIT TO A WALL ELECTRIC OUTLET

Please carefully read and follow instructions and safety warnings in "Fireplace Homeowners Operating Manual" to operate your fireplace.

WARNING

IF THE INFORMATION IN THE FIREPALCE OPERATING MANUAL IS NOT FOLLOWED, AN ELECTRIC SHOCK OR FIRE MAY RESULT IN PROPERTY DAMAGE, PERSONAL INJURY, OR LOSS OF LIFE.

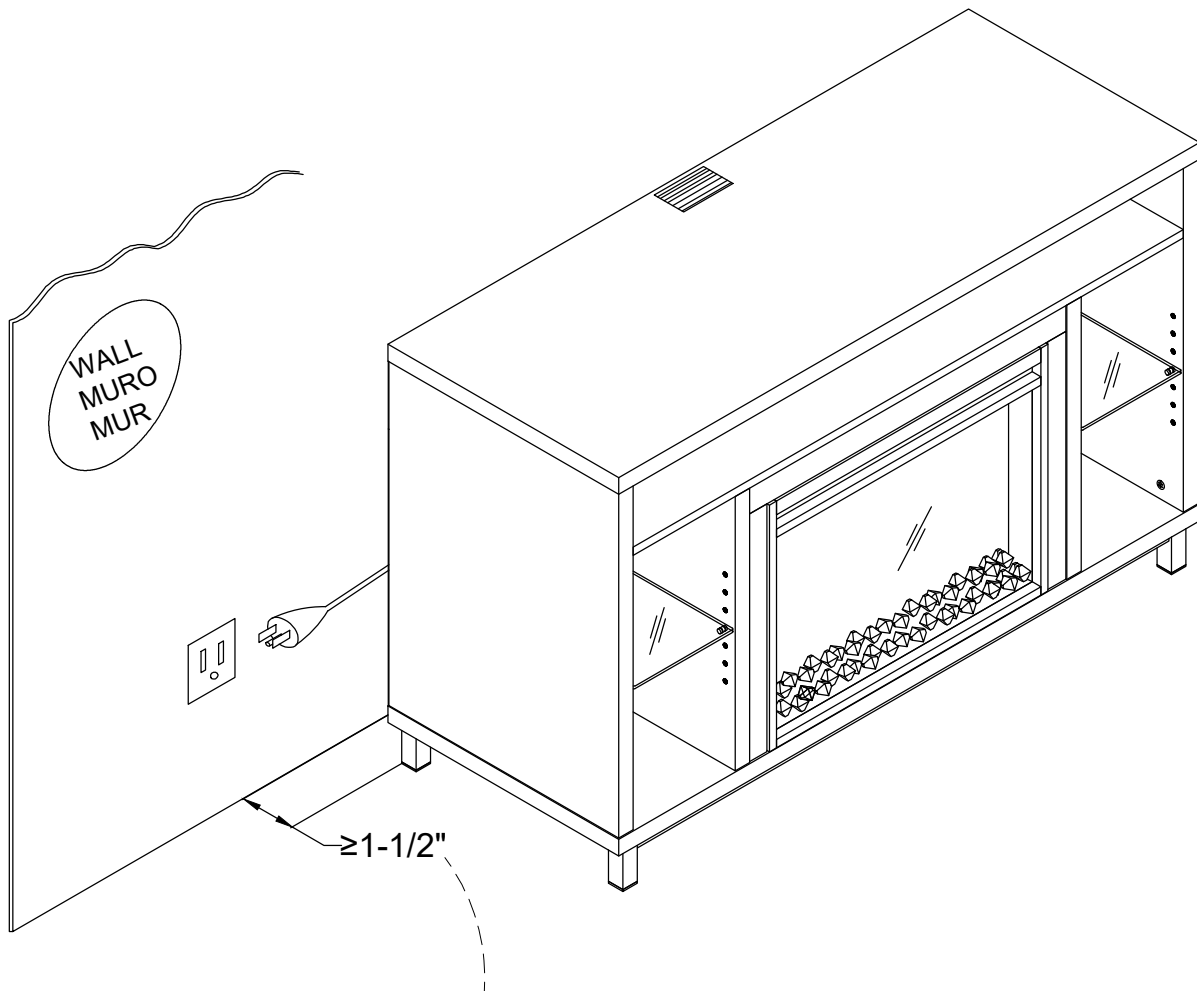

To allow proper heater ventilation, this unit must be located a minimum of 1-1/2" away from a back wall.

Maximum Loads

This unit has been designed to support the maximum loads shown. Exceeding these load limits could cause sagging, instability, product collapse, and/or serious injury.

Notice: Apply the warning label to the center of the top panel as shown, ensure the TV covers the label in use. You will not be able to remove the label after it is applied to the top panel.

Maximum TV size: 48" flat screen

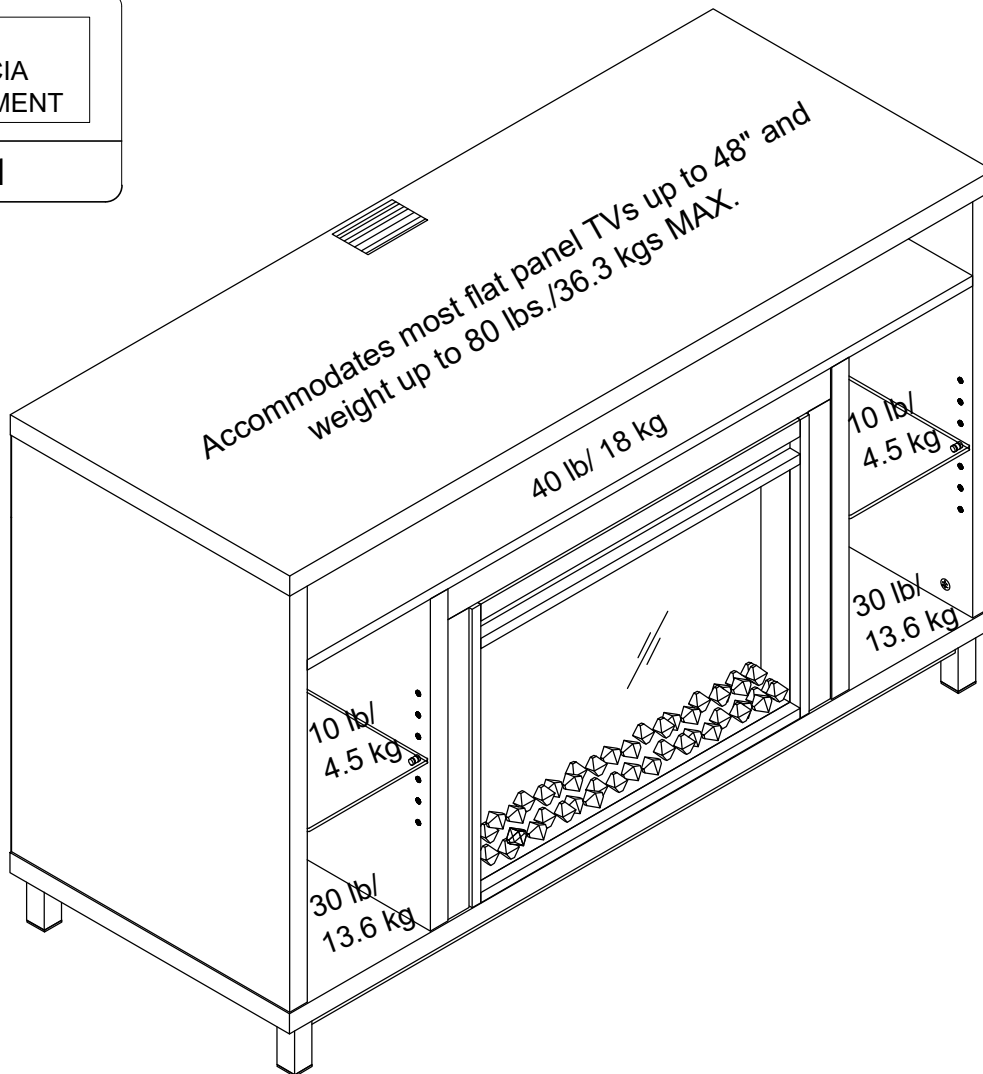
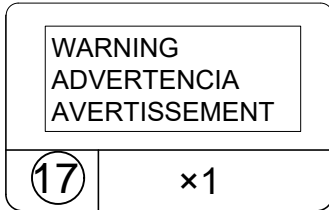

Certificate of Conformity

1. This certificate applies to the Dorel Home Furnishings, Inc. product identified by this instruction manual.
2. This certificate applies to compliance of this product with the CPSC Ban on Lead-Containing Paint (16 CFR 1303).
3. This product is distributed by: Dorel Home Furnishings, Inc.
410 East First Street South
Wright City, MO 63390
636-745-3351
4. Site of Manufacture: Binh Duong, Viet Nam.
5. See front page of instruction manual for date of manufacture.

Register your product to receive the following:



- * New trend details - sneak peek on what's new
- * Surveys - have a voice within our community
- * Exclusive deals and discount codes
- * Quick and easy replacement part service

To register your product, visit ameriwoodhome.com

5 Star Rating



Visit your local retailer's website, rate your purchased product and leave us some feedback!

We would like to extend a big "Thank You" to all of our customers for taking the time to assemble this Ameriwood Home product, and to give us your valuable feedback.

*Thank
You!*

Couverture Avant

CE LIVRET D'INSTRUCTION CONTIENT DES INFORMATIONS **IMPORTANTES** SUR LA SÉCURITÉ.
VEUILLEZ LIRE ET GARDER POUR UNE RÉFÉRENCE FUTURE

Ne retournez pas ce produit! Contactez notre équipe de service à la clientèle amicale d'abord pour obtenir de l'aide.

Appelez-nous: 1-800-489-3351 (sans frais) du Lundi au Vendredi de 9h à 17h Heure Centrale

Visitez: www.ameriwoodhome.com

ATTENTION

Le meuble peut basculer et causer des blessures graves ou la mort.

Ancrer le meuble à une planche murale dans le mur (si indiqué).

Ne laissez pas les enfants grimper sur le meuble.

Placez les articles lourds sur les étagères ou dans les tiroirs inférieurs.

Astuces Utiles (page 2)

- Ouvrez votre article dans la zone que vous prévoyez de le garder pour moins de levage lourd
- Identifier, trier et compter les pièces avant d'essayer d'assembler
- Les goujons de compression sont taraudés avec un Marteau
- Les glissières sont marquées d'un R (droit) et d'un L (gauche) pour un bon placement
- Assurez-vous toujours de faire face la pointe situé sur le haut de la Serrure de Came vers le bord extérieur
- Utiliser tous les clous fournis pour le panneau arrière et les répartir également
- Le panneau arrière doit être utilisé pour vous assurer que votre appareil est robuste
- N'utilisez pas de produits chimiques agressifs ou de nettoyeurs abrasifs sur cet appareil
- Ne jamais pousser, tirer, ou faire glisser votre meuble

Avant de Commencer (page 3)

- Lisez attentivement chaque étape et suivez le bon ordre
- Séparez et comptez toutes vos pièces et matériaux
- Donnez-vous suffisamment de place pour l'assemblage
- Avoir les outils suivants: tournevis à tête plate, #2 tournevis Phillips, et Marteau
- Attention: Si vous utilisez une perceuse électrique ou un tournevis électrique pour visser, veuillez à ralentir et arrêter lorsque la vis est bien serrée. Le non-respect de cette consigne peut endommager la vis.

Système de Fixation de Came (page 3)

Ce Système de Fixation de Came sera utilisé tout au long de l'assemblage.

Page 4-6: Identification du conseil

Pas la taille réelle

- (A) PANNEAU SUPÉRIEUR
- (B) PANNEAU INFÉRIEUR
- (C) ÉTAGÈRE FIXE
- (D) PANNEAU SUPÉRIEUR ARRIÈRE
- (E) PANNEAU LATÉRAL GAUCHE
- (F) PANNEAU CTÉ DROIT
- (G) PANNEAU CENTRAL GAUCHE
- (H) PANNEAU CENTRAL DROIT
- (J) RAIL SUPÉRIEUR
- (K) RAIL GAUCHE
- (L) RAIL DROIT
- (M) PANNEAU ARRIÈRE
- (N) PANNEAU CENTRAL SUPÉRIEUR
- (P) TABLETTE EN VERRE
- (Q) TUBE DE CADRE LATÉRAL
- (R) TUYAU DE SUPPORT
- (S) CHEMINEE

Page 7 Liste des pièces

Taille actuelle

- (1) serrure à came
- (2) Boulon à came
- (3) Cheville en bois
- (4) Vis
- (5) Vis
- (6) Vis
- (7) Boulon
- (8) Boulon

Pas de taille réelle

- (9) Colle
- (10) Plaque de métal
- (11) Support d'étagère
- (12) Clip de fil
- (13) Rondelle élastique
- (14) Rondelle
- (15) Équerre d'équerre
- (16) Clé hexagonale
- (17) Étiquette d'avertissement

Page 8

- 1.1 Fixez le boulon à came (2) dans (A), (B) et (C) comme illustré.
- 1.2 Insérez (3) dans (C) comme illustré.

Page 9

- 2.1 Fixez le boulon à came (2) dans (E), (F), (G) et (H) comme illustré.
- 2.2 Insérez (3) dans (E), (F), (G) et (H) comme illustré.

Page 10

- 3.1 Insérez (3) dans (N) x 2, (J), (K) et (L) comme illustré.
- 3.2 Fixez (10) dans (J) avec (5) comme illustré.

Page 11

- 4.1 Attachez (J) à (C) avec (1) comme illustré.
- 4.2 Fixez la barre lumineuse à DEL dans (C) avec (5) comme illustré.
- 4.2 Fixez (12) dans (C) avec (5) comme illustré.

Page 12

- 5.1 Fixez (K) dans (G) avec (1) comme illustré.
- 5.2 Fixez (L) dans (H) avec (1) comme illustré.
- 5.3 Fixez (G), (H) dans (C) avec (1) comme illustré.

Page 13

- 6.1 Fixez (E), (F) dans (C) avec (1) comme illustré.
- 6.2 Fixez (K), (L) dans (10) avec (5) comme illustré.

Page 14

7.1 Fixez (Q) dans (B) avec (7), (13) et (14) comme illustré.

7.2 Fixez (R) dans (B) avec (7), (13) et (14) comme illustré.

7.3 Fixez (R) dans (Q) avec (8), (13) et (14) comme illustré.

Page 15

8.1 Fixez (B) dans (E), (F), (G) et (H) avec (1) comme illustré.

Page 16

9.1 Fixez (N) x 2 dans (C) avec (1) comme illustré.

Page 17

10.1 Fixez (A) dans (E), (F) et (N) avec (1) comme illustré.

Page 18

11.1 Fixez (D) dans (A), (C) avec (4) comme illustré.

11.2 Fixez (M) x 2 dans (B) (E), (F), (G) et (H) avec (4) comme illustré.

Page 19

12.1 Insérez le foyer dans le SUPPORT TV tel qu'illustré.

12.2 Insérez le cordon d'alimentation DEL dans le foyer comme illustré ci-dessous.

Page 20

13.1 Fixez (S) dans (K), (L) avec (6) comme illustré.

13.2 Fixez (15) dans (B) avec (6) comme illustré.

Page 21

14.1 Fixez (11) dans (E), (F), (G), (H) comme illustré.

14.2 Mettez (P) sur la goupille de la tablette comme illustré.

14.3 Appliquez l'étiquette d'avertissement (17) sur la surface supérieure afin d'avoir toujours les limites de poids et de taille du téléviseur du modèle.

Page 22**AVANT DE BRANCHER L'APPAREIL À UNE PRISE ÉLECTRIQUE MURALE**

Veuillez lire attentivement et suivre les instructions et les avertissements de sécurité du « Manuel d'utilisation du foyer pour les propriétaires de foyer » pour faire fonctionner votre foyer.

ATTENTION

SI LES INFORMATIONS CONTENUES DANS LE MANUEL D'UTILISATION DU FIREPALCE NE SONT PAS SUIVI, UN CHOC ÉLECTRIQUE OU UN INCENDIE POURRAIT ENTRAÎNER DES DOMMAGES MATÉRIELS, DES BLESSURES CORPORELLES OU LA MORT.

Page 23**CHARGE MAXIMALE**

Cette unité a été conçue pour supporter les charges maximales indiquées. Le dépassement de ces limites de charge peut provoquer un affaissement, une instabilité, un effondrement du produit et/ou des blessures graves.

Avis : Appliquez l'étiquette d'avertissement au centre du panneau supérieur comme indiqué, assurez-vous que le téléviseur recouvre l'étiquette en cours d'utilisation. Vous ne pourrez pas retirer l'étiquette après l'avoir appliquée sur le panneau supérieur.

Taille maximale du téléviseur : écran plat de 48"

Page 24

Enregistrez votre produit pour recevoir les éléments suivantes:

- * Détails sur les nouvelles tendances - un aperçu sur les nouveautés
- * Sondages - avoir une voix au sein de notre communauté
- * Offres exclusives et codes promo
- * Service de pièces de rechange rapide et facile

Pour enregistrer votre produit, visitez ameriwoodhome.com

5 Étoiles

Visitez le site Web de votre détaillant local, évaluez le produit que vous avez acheté et laissez-nous vos commentaires !

Nous tenons à offrir un grand "Merci" à tous nos clients pour avoir pris le temps d'assembler ce produit "Ameriwood Home", et de nous donner vos commentaires précieux.

Merci

Cubierta Delantera

Este libro de instrucciones contiene información **IMPORTANTE** de seguridad. Por favor lea y manténgalo para referencia en el futuro.

No Regrese este producto! Comuníquese con nuestro amistoso equipo de servicio al cliente para obtener ayuda.

Llámenos al: 1-800-489-3351 (Gratis) Lunes - Viernes 9am - 5pm CST

Visitar: www.ameriwoodhome.com

PRECAUCION

Este mueble puede volcarse y causar graves heridas y/o muerte.

Anclar el mueble a un poste de madera en la pared (si esto se requiere).

No Permita que los niños monten el mueble.

Mantenga los artículos más pesados en los cajones de abajo.

Consejos Útiles (página 2)

- Abra su artículo en el área donde usted planea utilizarlo para evitar levantar y moverlo menos
- Identificar, ordenar y contar las piezas antes de intentar ensamblar
- Las clavijas de compresión se golpean con un martillo
- Las diapositivas están marcadas con una R (derecha) y L (izquierda) para la colocación correcta
- Asegúrese de que siempre este el punto localizado en la parte superior de bloqueador de leva este volteado hacia borde exterior
- Utilizar todos los clavos para el panel de atrás y distribuirlos por igual
- El panel de atrás debe utilizarse para asegurarse de que la unidad quede fija y firme
- No use químicas fuertes ni limpiadores abrasivos en este artículo
- Nunca empuje, tire ni arrastre los muebles

Antes de Que Empieces (página 3)

- Lea cuidadosamente cada paso y siga el orden correcto

- Separar y contar todas sus piezas y hardware

- Dése suficiente espacio para el proceso de ensamble

- Tenga las siguientes herramientas: destornillador de cabeza plana, #2 cabeza Phillips

Destornillador y martillo

- Precaución: Si usa un taladro electrónico o un destornillador eléctrico para atornillar, por favor asegúrese que deje de atornillar cuando el tornillo este apretado. Fallar hacer esto puede causar barrer el tornillo.

Sistema de fijar el bloqueo de leva (página 3)

Esta sistema de fijar el bloqueo de leva sera usado en todo el proceso ensamble.

Página 4-6: Identificación de la Junta No es la talla actual

- (A) PANEL SUPERIOR
- (B) PANEL INFERIOR
- (C) ESTANTE FIJO
- (D) PANEL TRASERO SUPERIOR
- (E) PANEL LATERAL IZQUIERDO
- (F) PANEL LATERAL DERECHO
- (G) PANEL MEDIO IZQUIERDO
- (H) PANEL MEDIO DERECHO
- (J) BARANDILLA SUPERIOR
- (K) CARRIL IZQUIERDO
- (L) RIEL DERECHO
- (M) PANEL FIJO
- (N) PANEL MEDIO SUPERIOR
- (P) ESTANTE DE CRISTAL
- (Q) TUBO DE MARCO LATERAL
- (R) TUBO DE SOPORTE
- (S) CHIMENEA

Página 7: Lista de Tamaño real

- (1) Bloqueo de leva
- (2) Perno de leva
- (3) Pasador de madera
- (4) Tornillo
- (5) Tornillo
- (6) Tornillo
- (7) Perno
- (8) Perno

No es la talla actual

- (9) Pegamento
- (10) Placa de metal
- (11) Soporte de estantería
- (12) Clip de alambre
- (13) Arandela de resorte
- (14) Arandela
- (15) Escuadra
- (16) Llave hexagonal
- (17) Etiqueta de advertencia

Página 8

- 1.1 Coloque el perno de leva (2) en (A), (B) y (C) como se ilustra.
- 1.2 Inserte (3) en (C) como se ilustra.

Página 9

- 2.1 Coloque el perno de leva (2) en (E), (F), (G) y (H) como se ilustra.
- 2.2 Inserte (3) en (E), (F), (G) y (H) como se ilustra.

Página 10

- 3.1 Inserte (3) en (N) x 2, (J), (K) y (L) como se ilustra.
- 3.2 Conecte (10) en (J) con (5) como se ilustra.

Página 11

- 4.1 Conecte (J) a (C) con (1) como se ilustra.
- 4.2 Conecte la barra de luz LED en (C) con (5) como se ilustra.
- 4.2 Conecte (12) en (C) con (5) como se ilustra.

Página 12

- 5.1 Conecte (K) en (G) con (1) como se ilustra.
- 5.2 Conecte (L) en (H) con (1) como se ilustra.
- 5.3 Conecte (G), (H) en (C) con (1) como se ilustra.

Página 13

- 6.1 Conecte (E), (F) en (C) con (1) como se ilustra.
- 6.2 Conecte (K), (L) en (10) con (5) como se ilustra.

Página 14

7.1 Conecte (Q) en (B) con (7), (13) y (14) como se ilustra.

7.2 Conecte (R) en (B) con (7), (13) y (14) como se ilustra.

7.3 Conecte (R) en (Q) con (8), (13) y (14) como se ilustra.

Página 15

8.1 Conecte (B) en (E), (F), (G) y (H) con (1) como se ilustra.

Página 16

9.1 Conecte (N) x 2 en (C) con (1) como se ilustra.

Página 17

10.1 Conecte (A) en (E), (F) y (N) con (1) como se ilustra.

Página 18

11.1 Conecte (D) en (A), (C) con (4) como se ilustra.

11.2 Conecte (M) x 2 en (B) (E), (F), (G) y (H) con (4) como se ilustra.

Página 19

12.1 Inserte la chimenea en el SOPORTE DE TV como se muestra en la ilustración.

12.2 Inserte el cable de alimentación LED a la chimenea como se muestra a continuación.

Página 20

13.1 Conecte (S) en (K), (L) con (6) como se ilustra.

13.2 Conecte (15) en (B) con (6) como se ilustra.

Página 21

14.1 Conecte (11) en (E), (F), (G), (H) como se ilustra.

14.2 Coloque (P) en el pasador del estante como se muestra en la ilustración.

14.3 Aplique la etiqueta de advertencia (17) en la superficie superior para que siempre tenga los límites de peso y tamaño del televisor del modelo.

Página 22

ANTES DE CONECTAR LA UNIDAD A UNA TOMA ELÉCTRICA DE PARED

Lea atentamente y siga las instrucciones y las advertencias de seguridad en el "Manual de funcionamiento del propietario de la chimenea" para hacer funcionar su chimenea.

ADVERTENCIA

SI NO SE CUMPLE LA INFORMACIÓN DEL MANUAL DE FUNCIONAMIENTO DE FIREPALCE, UNA DESCARGA ELÉCTRICA O UN INCENDIO PUEDEN PROVOCAR DAÑOS A LA PROPIEDAD, LESIONES PERSONALES O LA PÉRDIDA DE LA VIDA.

Página 23

CARGA MÁXIMA

Esta unidad ha sido diseñada para soportar las cargas máximas que se muestran. Exceder estos límites de carga podría causar flacidez, inestabilidad, colapso del producto y / o lesiones graves.

Aviso: aplique la etiqueta de advertencia en el centro del panel superior como se muestra, asegúrese de que el televisor cubra la etiqueta en uso. No podrá quitar la etiqueta después de que se aplique al panel superior.

Tamaño máximo de TV: pantalla plana de 48 "

Página 24

Registre su producto para recibir lo siguiente:

- * Detalles de nuevas tendencias - Vistazo a lo nuevo
- * Encuestas - alec su voz entre su comunidad
- * Códigos de ofertas y descuentos exclusivos
- * Fácil y rápido servicio de partes de remplace

Para registrar su producto, visite ameriwoodhome.com - Clasificación de 5 estrellas

Visite el sitio web de su distribuidor local, califique el producto que compró y déjenos sus comentarios.

Nos gustaría enviar un gran "Agradecimiento" a todos nuestros clientes por tomarse el tiempo de ensamblar este producto de Ameriwood Home, y por darnos sus valiosos comentarios.

Gracias