

1822296COM

Fireplace TV stand



Date of Purchase ___ / ___ / ___
Lot Number:

B341822296COM00GO

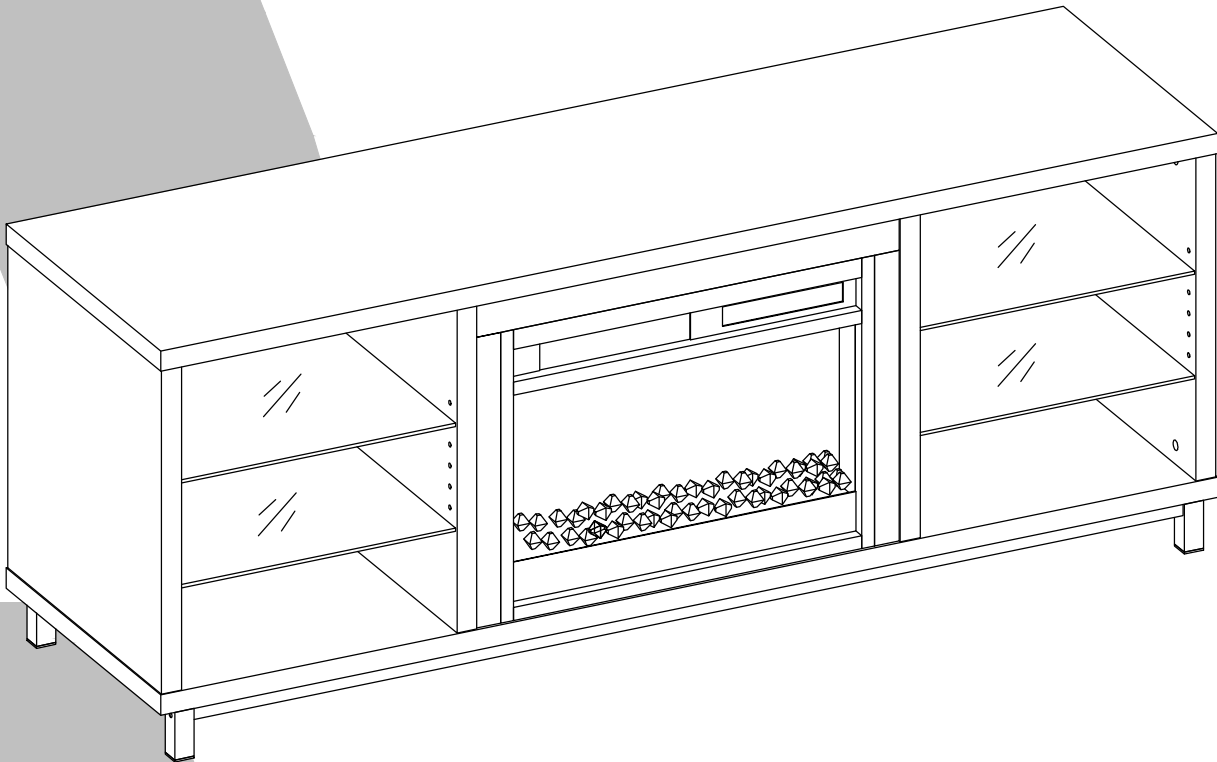

THIS INSTRUCTION BOOKLET CONTAINS **IMPORTANT** SAFETY INFORMATION. PLEASE READ AND KEEP FOR FUTURE REFERENCE.

Do Not Return This Product!

Contact our customer service team for help first.

Call: 1-800-489-3351 (toll free)

Monday-Friday 9am - 5pm CST

Visit: www.ameriwoodhome.com

WARNING

- Unit can tip over causing severe injury or death.
- Anchor unit to stud in wall (if instructed to).
- Do Not allow children to climb on unit.
- Put heavy items on lower shelves or drawers.

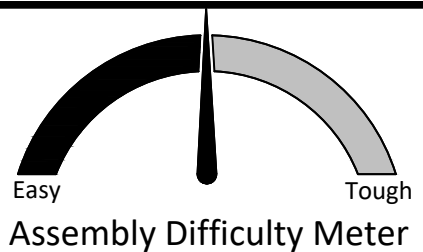

Follow Ameriwood Home



Do NOT return this product!

Contact our friendly customer service team first for help.

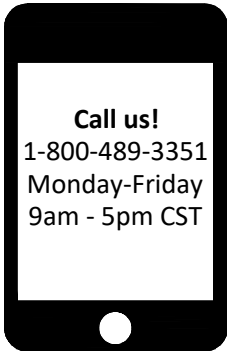

Visit ameriwoodhome.com

Assembly Tips



Helpful Hints

PEOPLE NEEDED FOR ASSEMBLY: 2

ESTIMATED ASSEMBLY TIME: 1 HOUR

- Open your item in the area you plan to keep it to avoid excessive heavy lifting.
- Identify, sort and count the parts before attempting assembly.
- Compression dowels are lightly tapped in with a hammer.
- Slides are labeled with a **R** (right) and **L** (left) for proper placement.
- Make sure to always face the point on the top of the Cam Lock towards the outer edge.
- Use all the nails provided for the back panel and spread them out equally.
- Back panel must be used to make sure your unit is sturdy.
- Do NOT use harsh chemicals or abrasive cleaners on this item.
- Never push, pull, or drag your furniture.

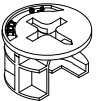

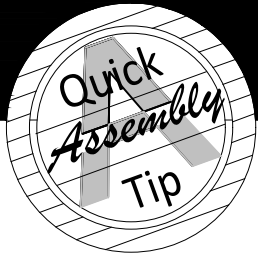

Before You Start

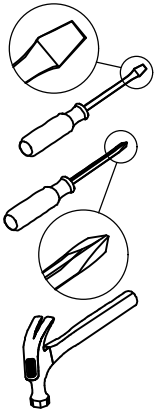

- ✓ Read through each step carefully and follow the proper order
- ✓ Separate and count all your parts and hardware
- ✓ Give yourself enough room for the assembly process
- ✓ Have the following tools: Flat Head Screwdriver, #2 Phillips Head Screwdriver and Hammer
- ✓ Caution: If using a power drill or power screwdriver for screwing, please be aware to slow down and stop when screw is tight. Failure to do so may result in stripping the screw.

Cam Lock Fastening System

This Cam Lock Fastening System will be used throughout the assembly process.

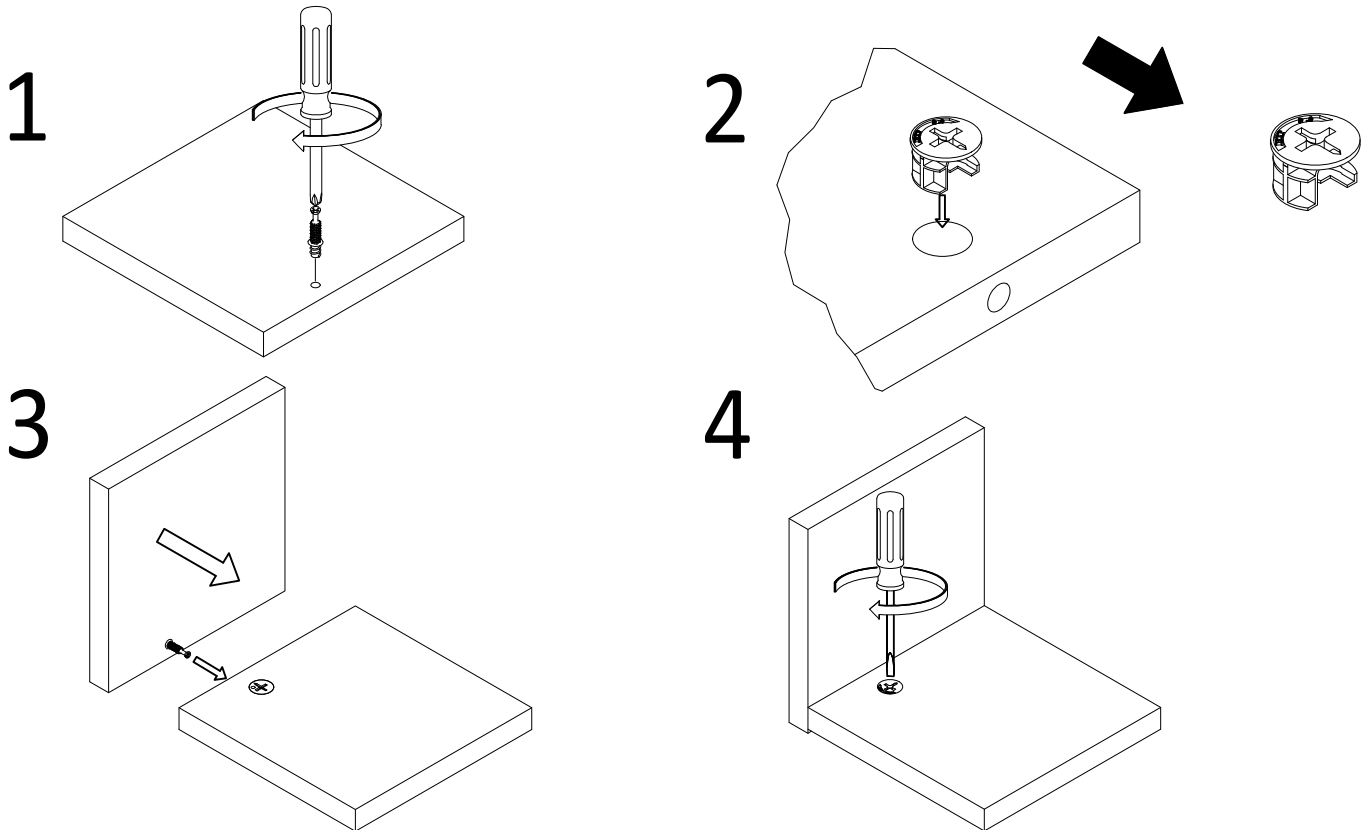

Board Identification

Not actual size

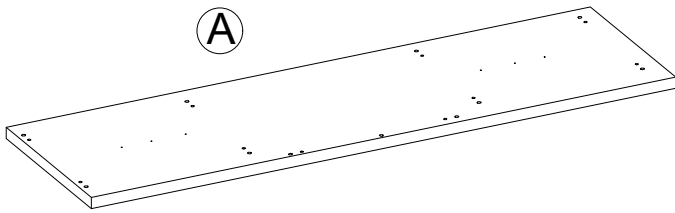

A
TOP SHELF
T1822296010GO
QTY: 1 PC

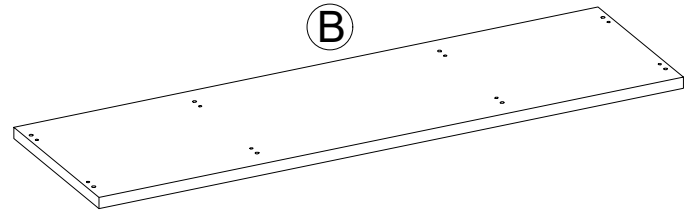

B
BOTTOM PANEL
T1822296020GO
QTY: 1 PC

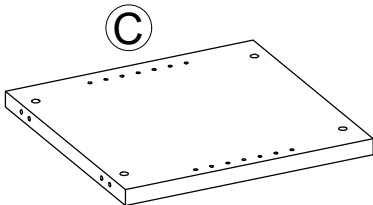

C
SIDE PANEL
T1822296030GO
QTY: 2 PCS

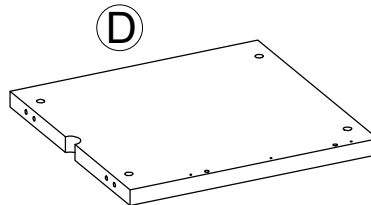

D
LEFT PARTITION
T1822296040GO
QTY: 1 PC

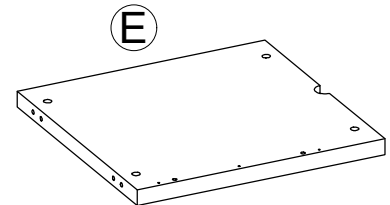

E
RIGHT PARTITION
T1822296050GO
QTY: 1 PC

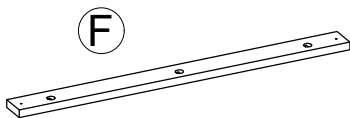

F
TOP SHELF APRON
T1822296060GO
QTY: 1 PC

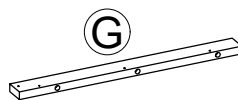

G
LEFT SIDE RAIL
T1822296070GO
QTY: 1 PC

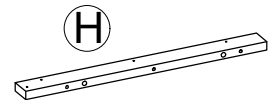

H
RIGHT SIDE RAIL
T1822296080GO
QTY: 1 PC

Board Identification

Not actual size

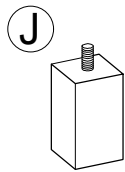

J
FOOT
T1822296090GO
QTY: 1 PC

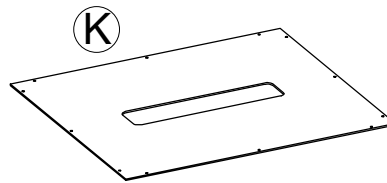

K
BACK PANEL
T1822296100GO
QTY: 2PCS

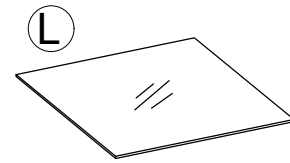

L
GLASS SHELF
T1822296110GO
QTY: 4PCS

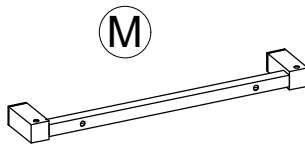

M
METAL FOOT FRAME
T1822296120GO
QTY: 2PCS

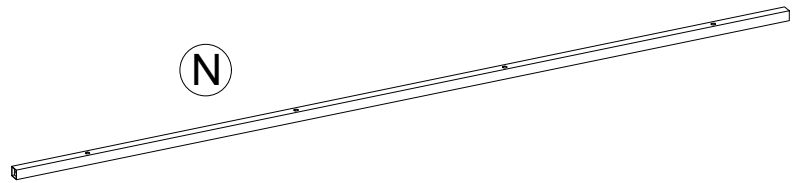

N
SUPPORT TUBE
T1822296130GO
QTY: 2PCS

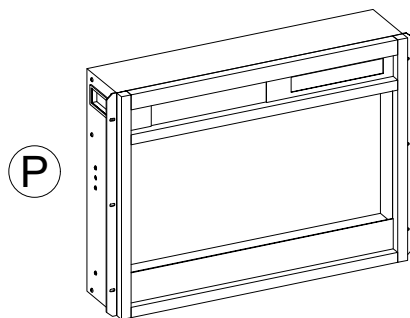

P
FIREPLACE
FA23V60L-C8
QTY: 1PC

Remote control	FA23V60L-C801
Acrylic crystal	FA23V60L-C802
LED light bar (2)	FA23V60L-C803

Board Identification

Not actual size

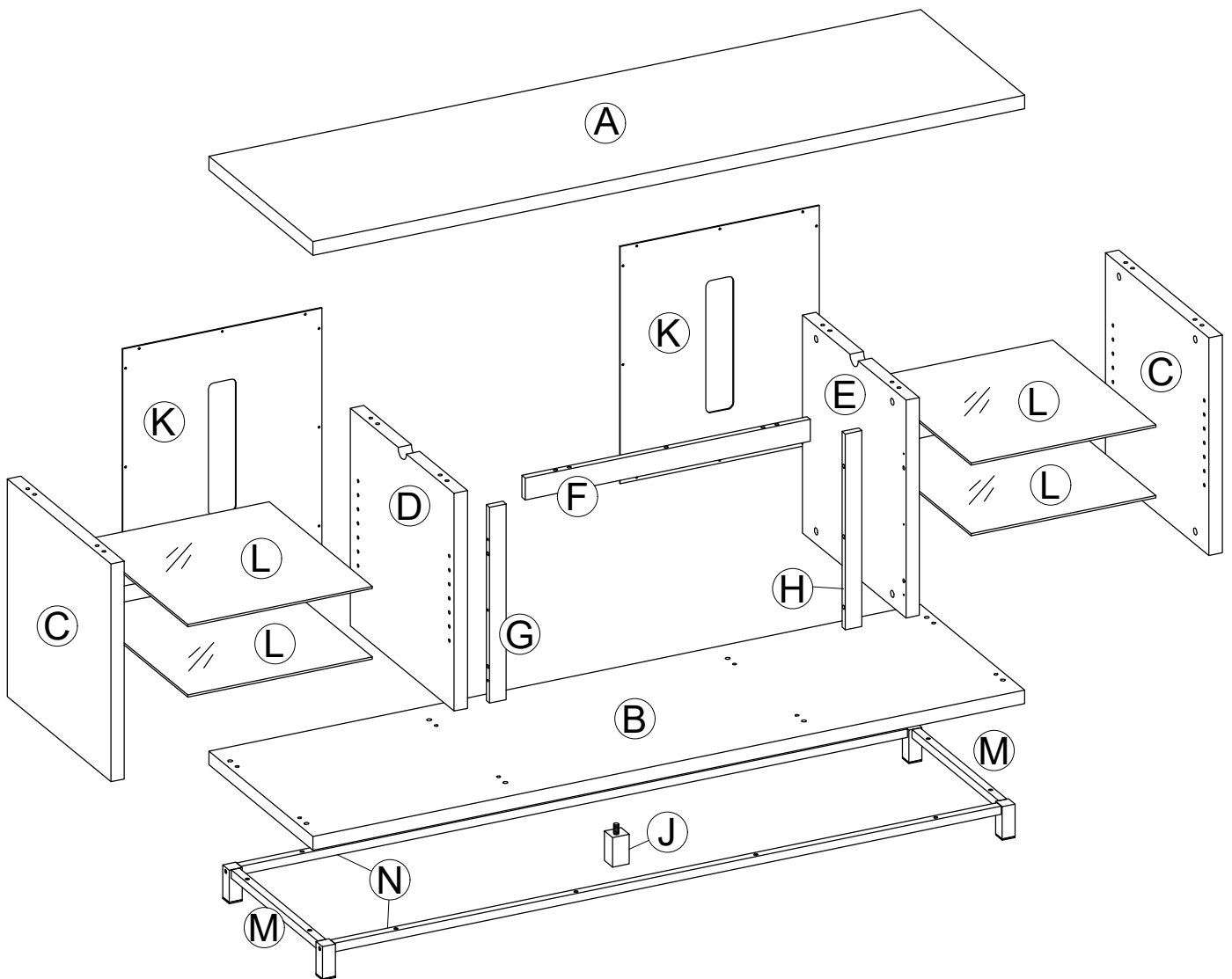

Part List

Actual Size

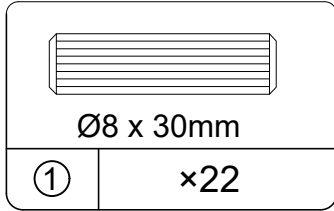

WOOD DOWEL
TGO2900

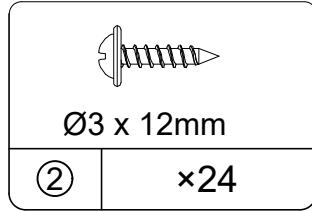

SCREW
TGO1301

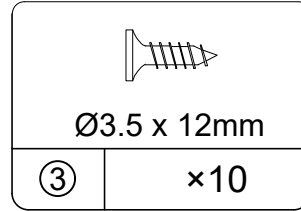

SCREW
TGO1007

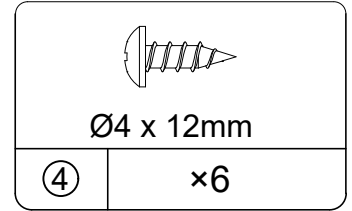

SCREW
TGO1323

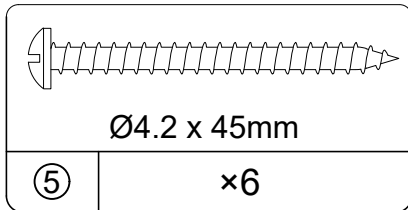

SCREW
TGO1013

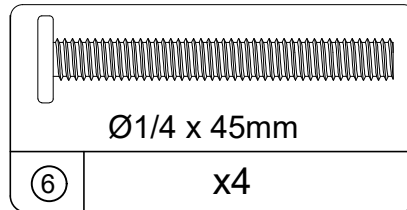

BOLT
TGO1623W

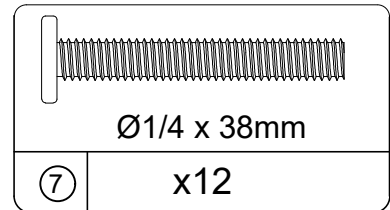

BOLT
TGO1630W

Part List

No Actual Size

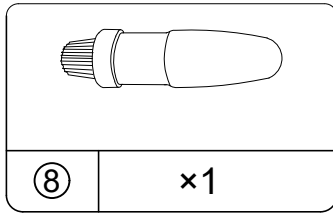

GLUE
TGO9001

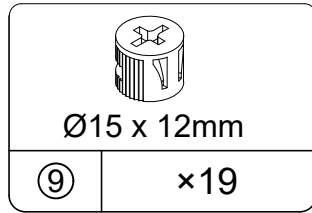

CAM LOCK
TGO2101

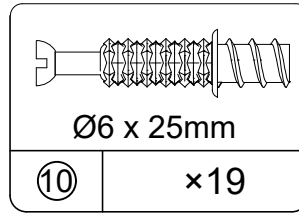

CAM BOLT
TGO2001

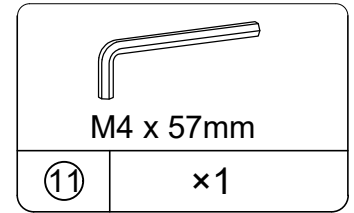

HEX KEY
TGO7001

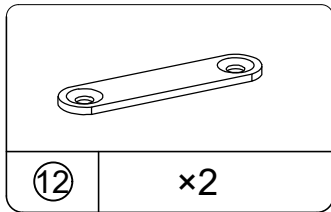

METAL PLATE
TGO3525

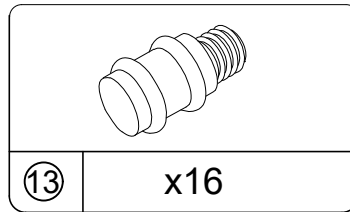

SHELF SUPPORT
TGO2811

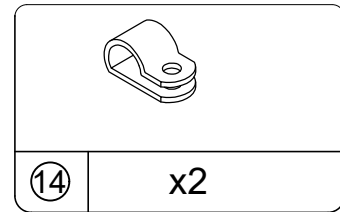

WIRE CLIP
TGO9093

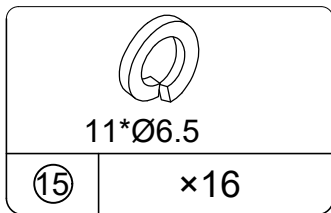

SPRING WASHER
TGO4606W

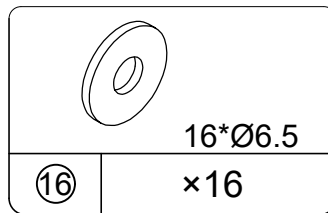

WASHER
TGO4604W

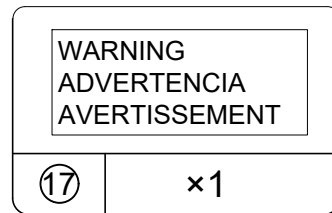

WARNING LABEL
TGO1822

STEP 1

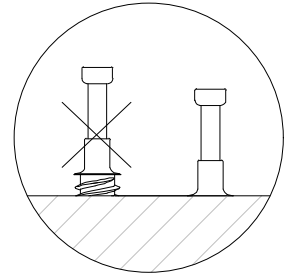
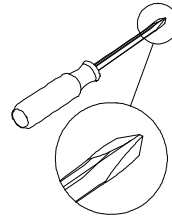
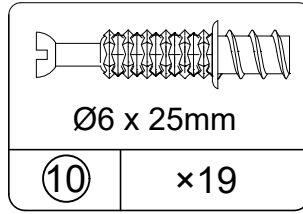
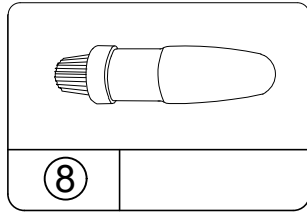
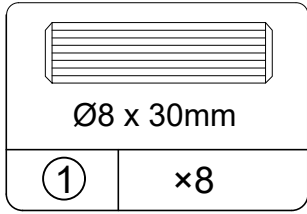

- 1.1 Cam bolt (10) into (A), (B) as illustrated.
 1.2 Insert (1) into (C) x 2 as illustrated.

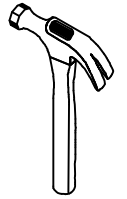
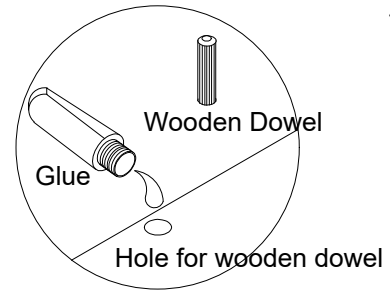

Use one drop of glue in dowel hole.

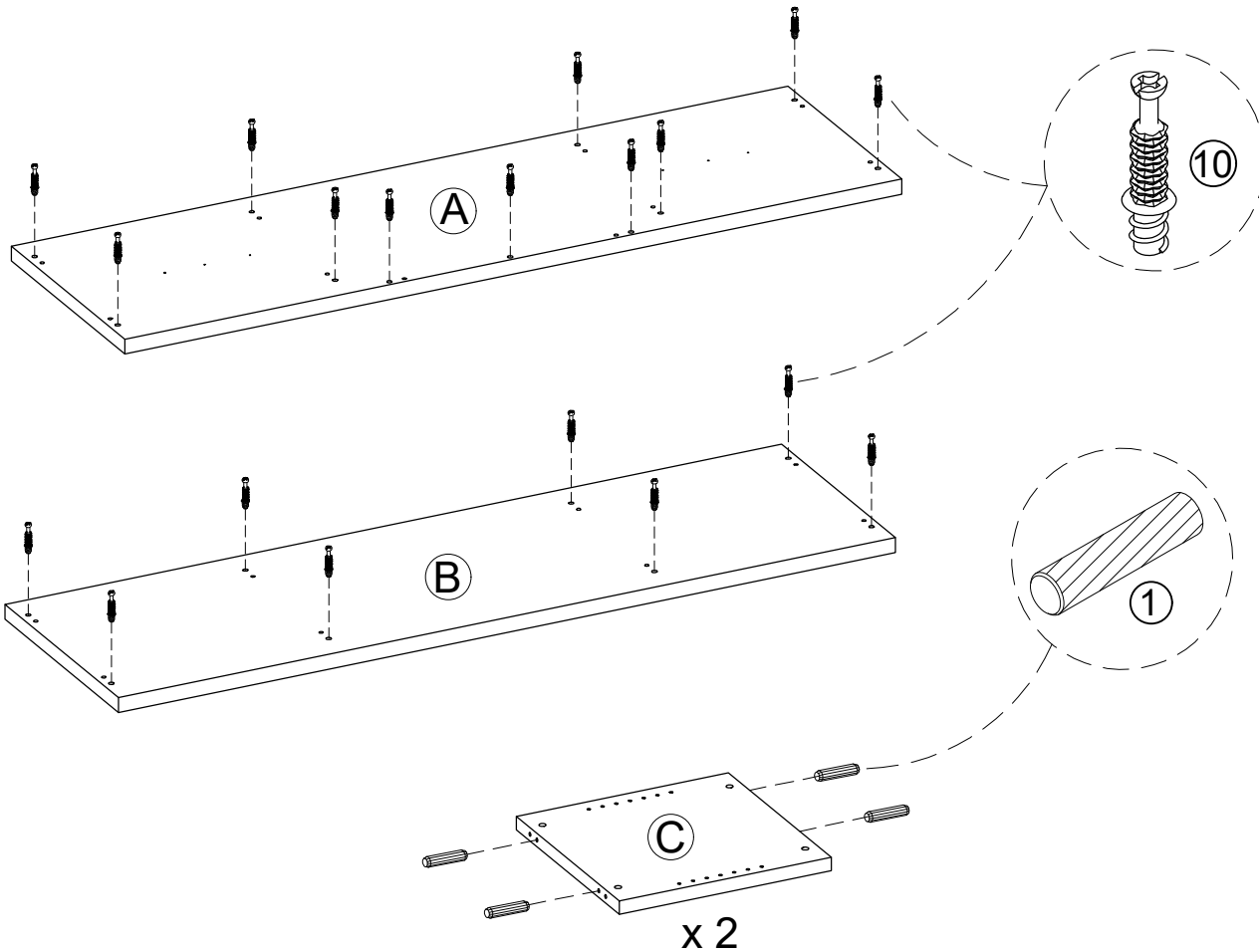

STEP 2

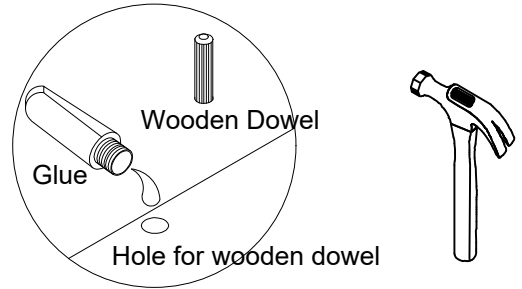
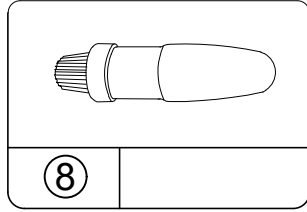
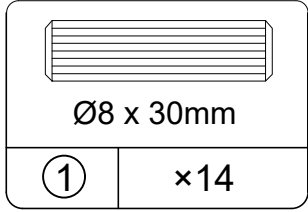

2.1 Insert (1) into (D), (E), (H), (F) and (G) as illustrated.

Use one drop of glue in dowel hole.

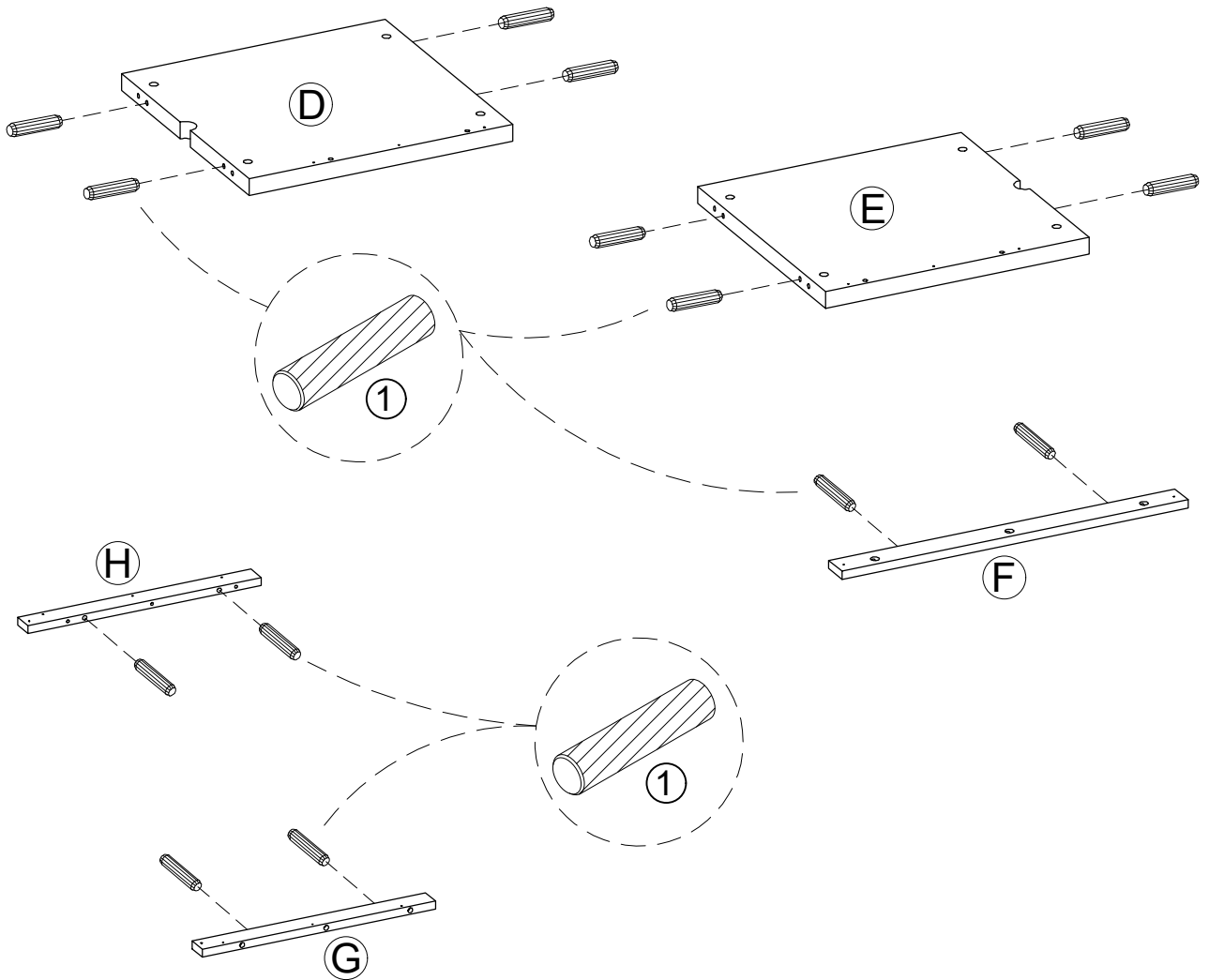

STEP 3

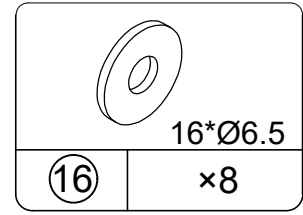
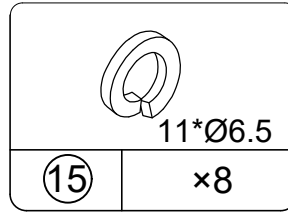
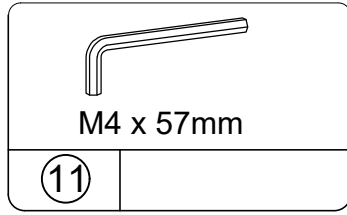
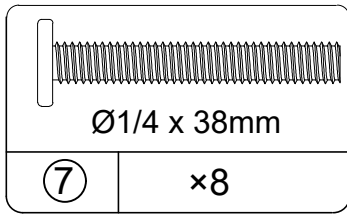

3.1 Attach (N) x 2 into (B) with (7), (15) and (16) as illustrated.

Note: DO NOT Tighten the bolt to ensure the assembly successfully in this step.

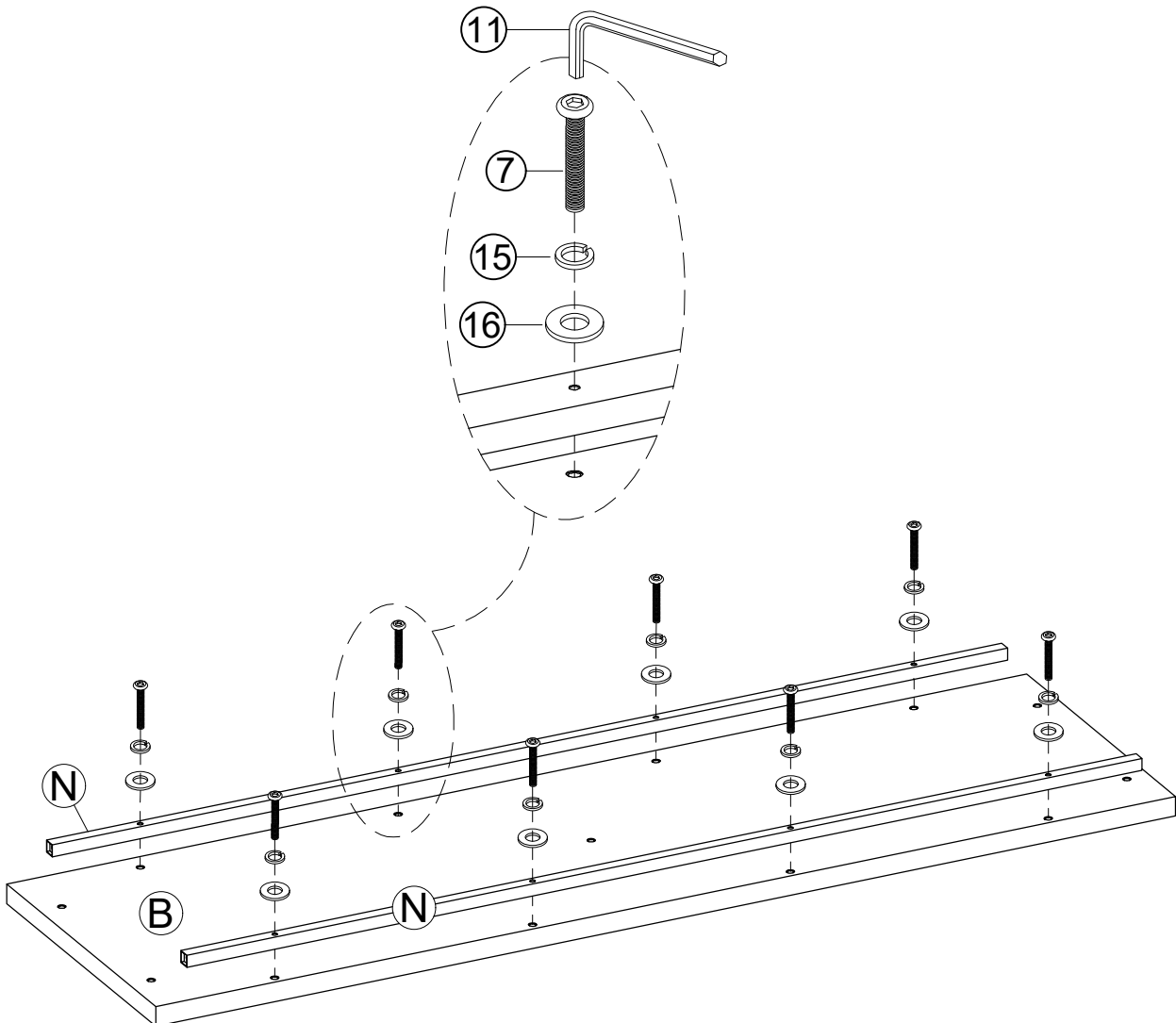

STEP 4

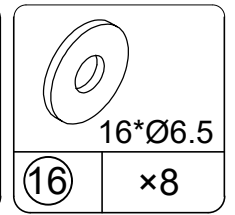
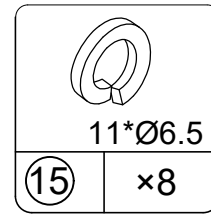
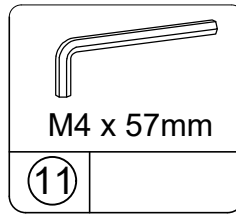
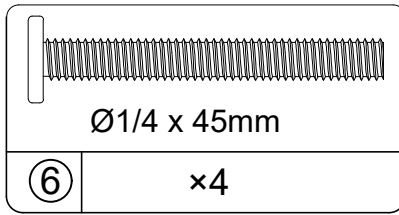
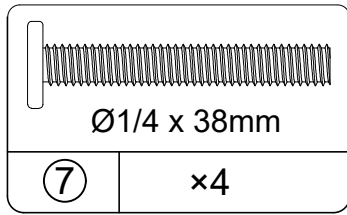

4.1 Attach (M) into (B) with (7), (15) and (16) as illustrated.

4.2 Attach (M) into (N) with (6), (15) and (16) as illustrated.

Note: DO NOT Tighten the bolt to ensure the assembly successfully in this step.

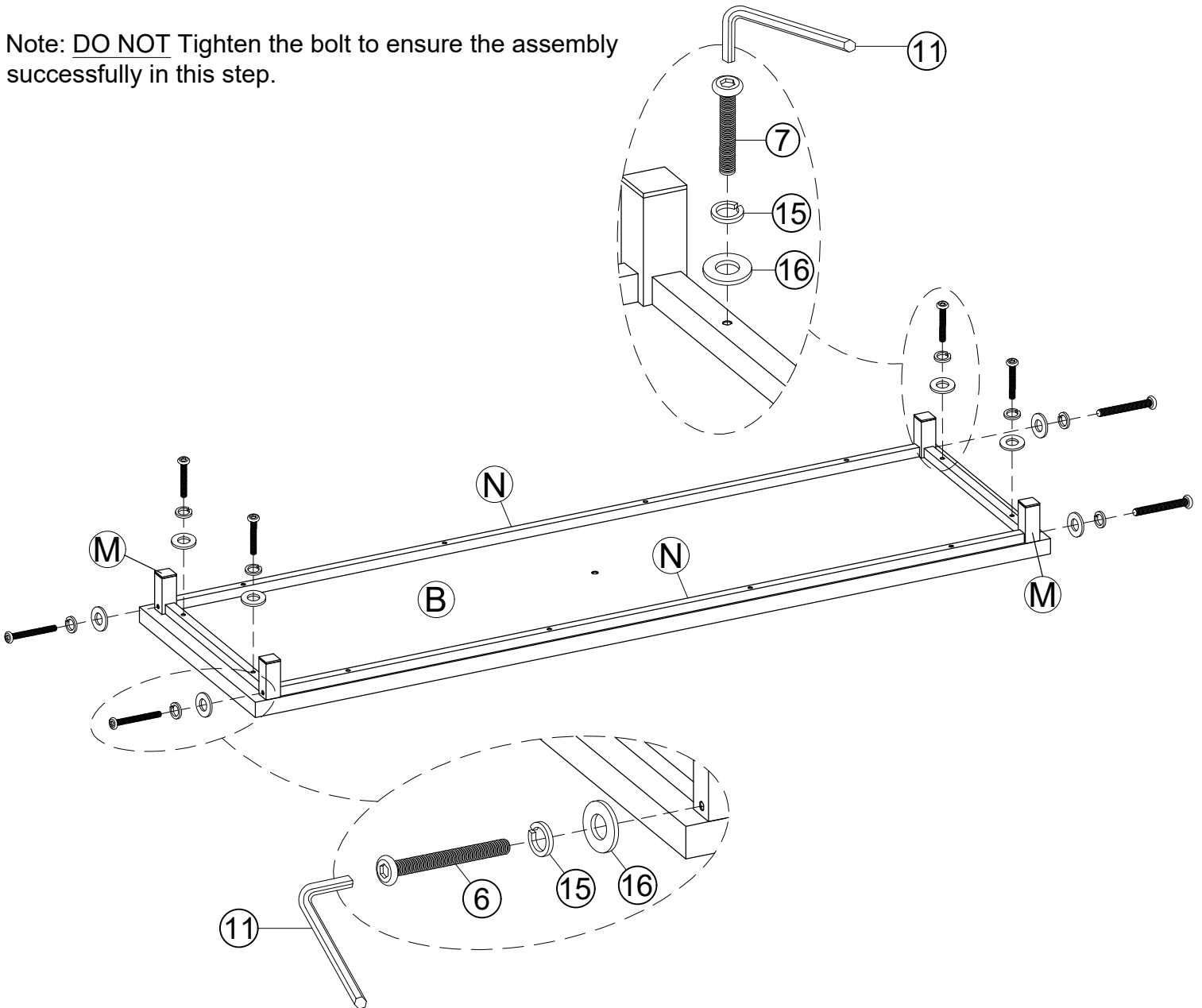

STEP 5

5.1 Attach (J) into (B) as illustrated.

Note: Tighten all bolts to secure the unit in this assembly step.

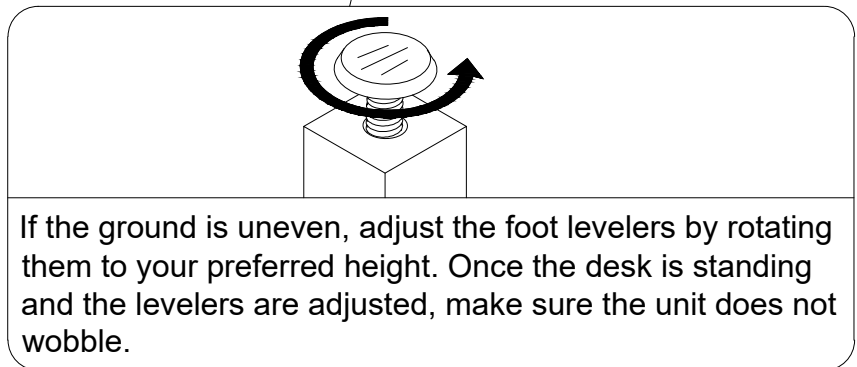
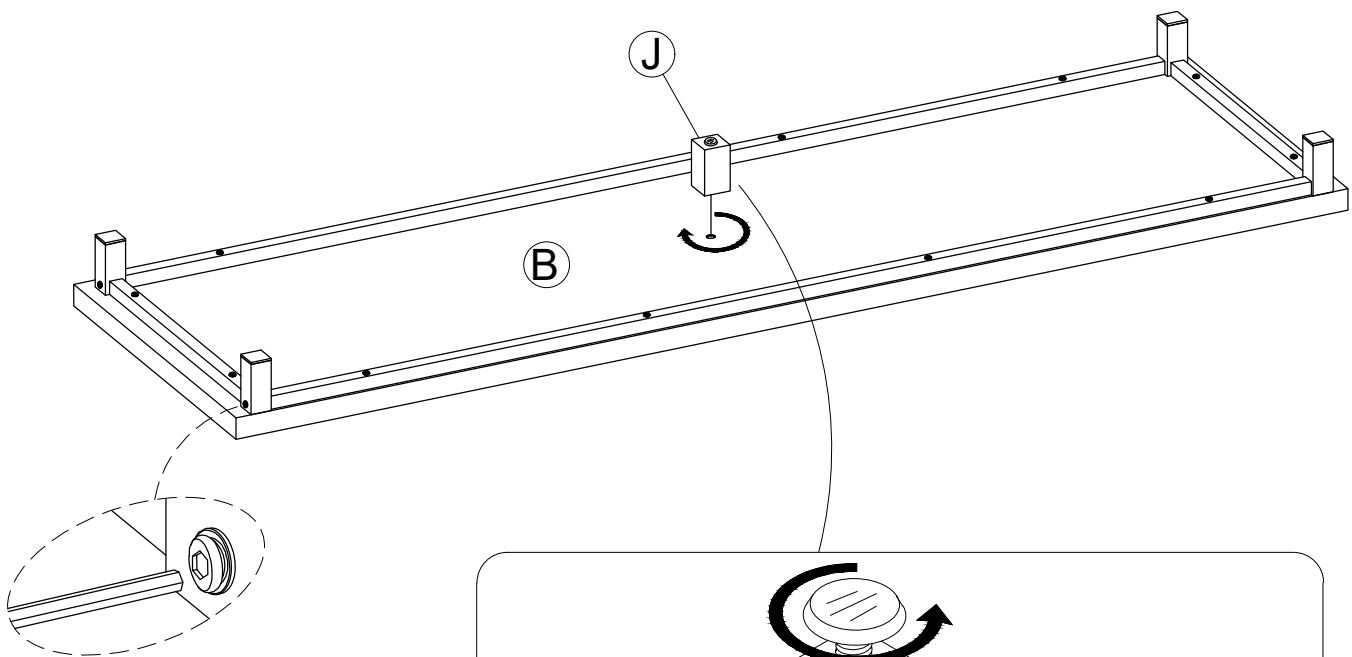

If the ground is uneven, adjust the foot levelers by rotating them to your preferred height. Once the desk is standing and the levelers are adjusted, make sure the unit does not wobble.

STEP 6

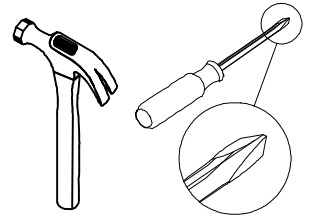
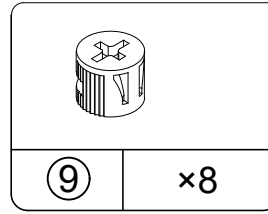
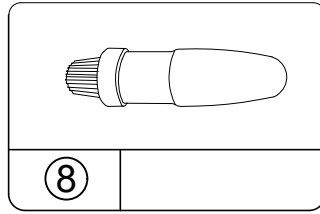
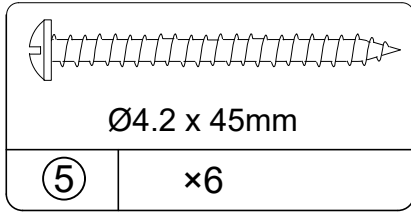

- 6.1 Attach (G) into (D) with (5) as illustrated.
- 6.2 Attach (H) into (E) with (5) as illustrated.
- 6.3 Attach (C) x 2, (D), (E) into (B) with (9) as illustrated.

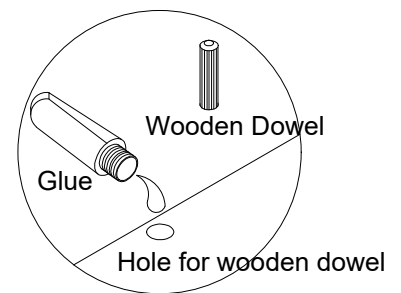
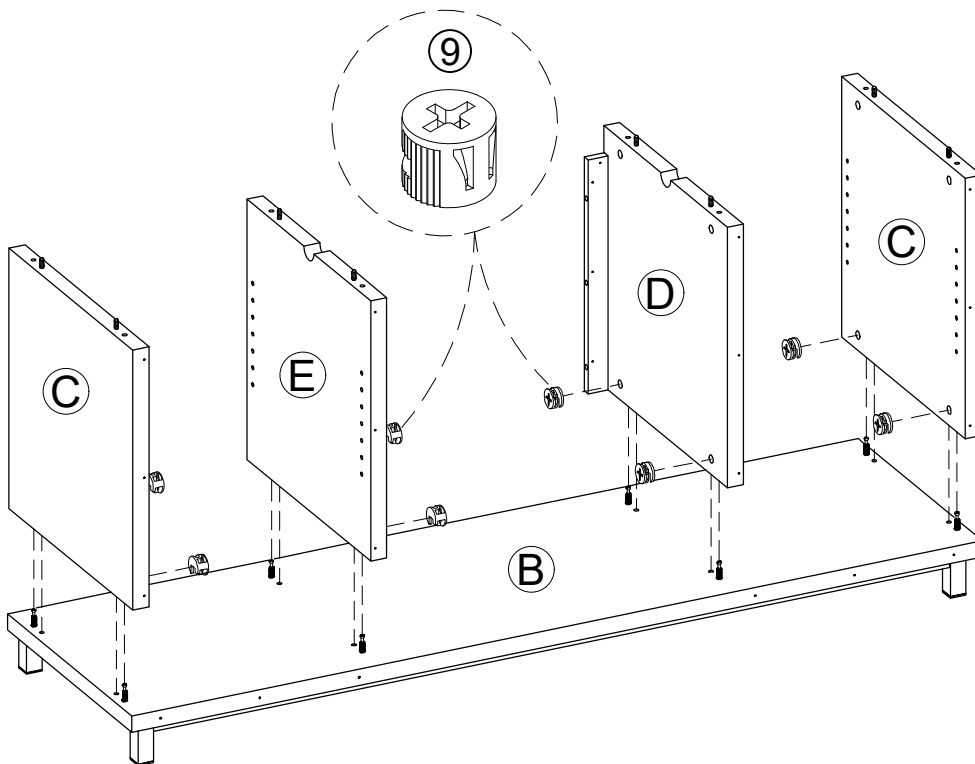
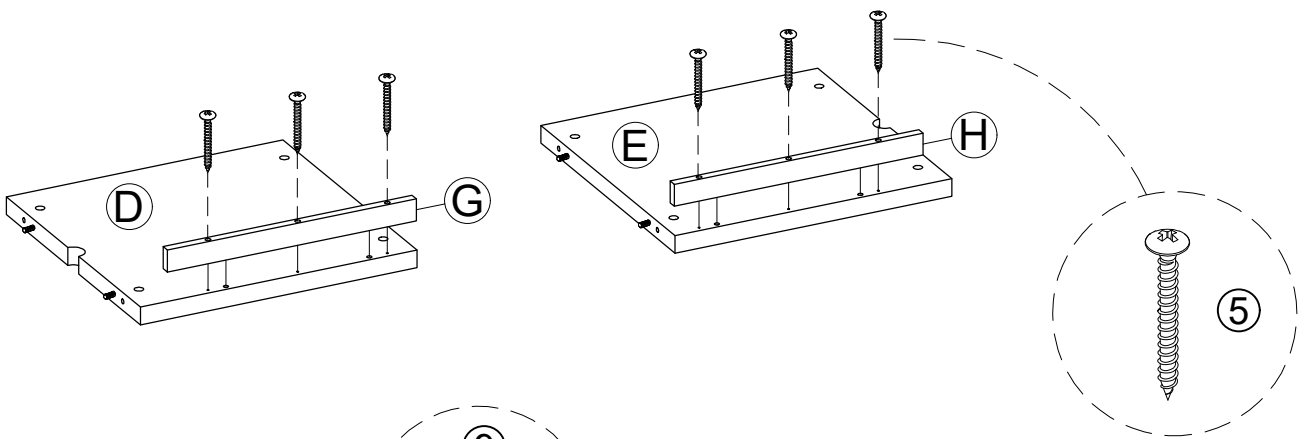
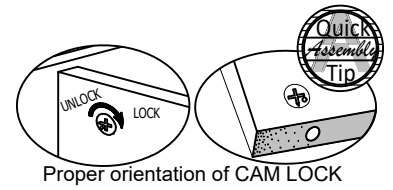

Use one drop of glue in dowel hole.

STEP 7

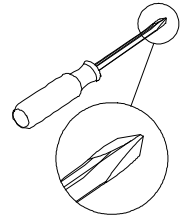
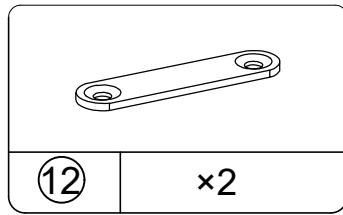
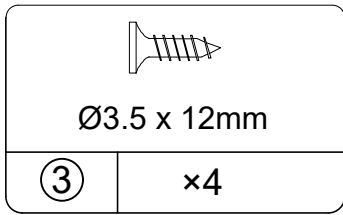

7.1 Attach (F) into (G), (H) with (12), (3) as illustrated.

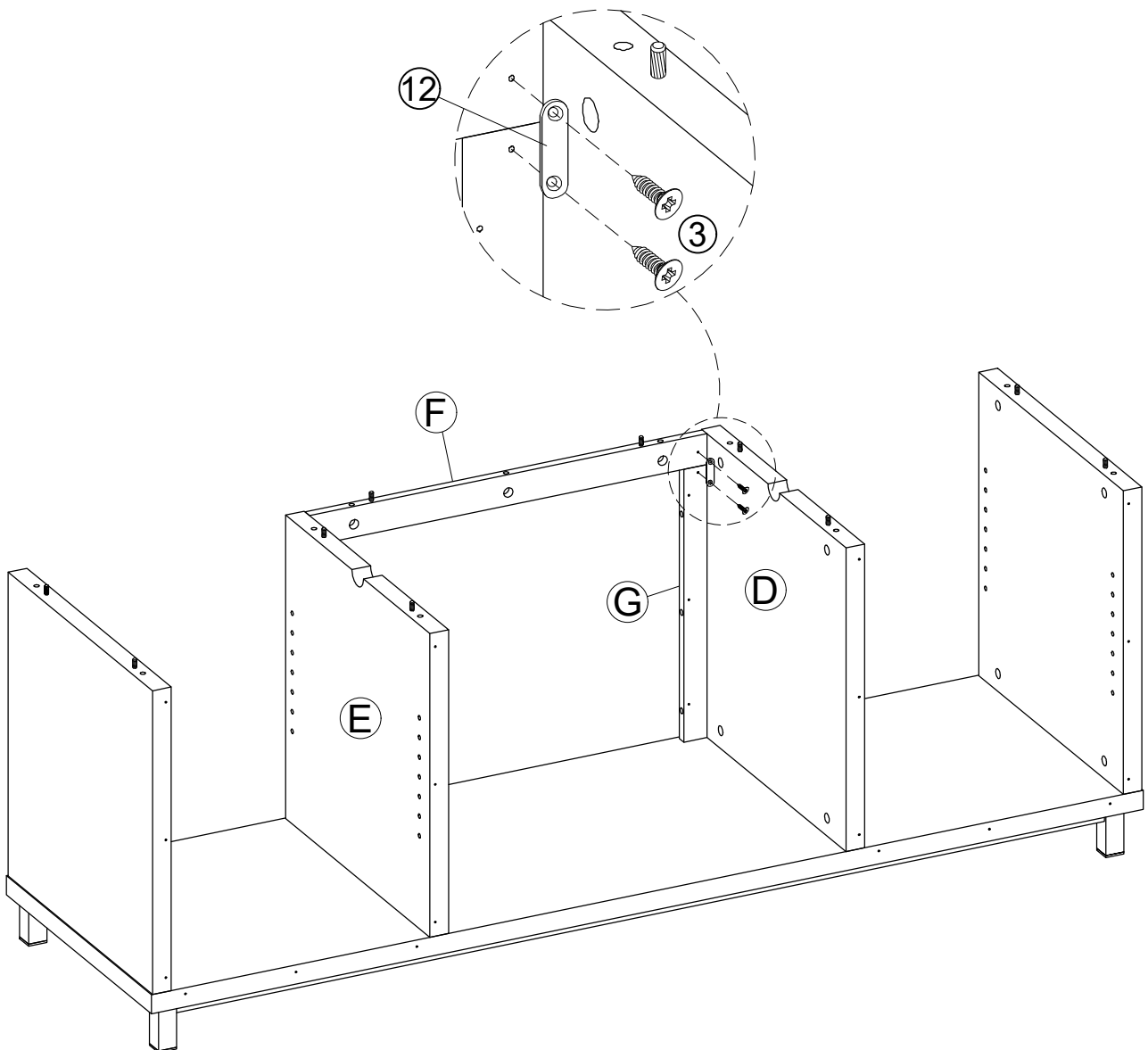

STEP 8

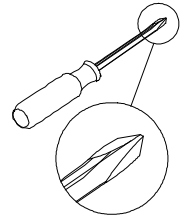
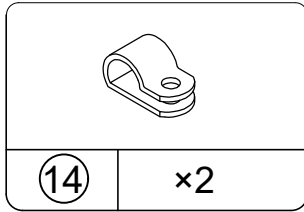
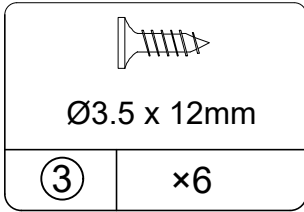

2 pcs LED light bars are packed in the small inner box.
 This small inner box is packed in the fireplace insert carton box.

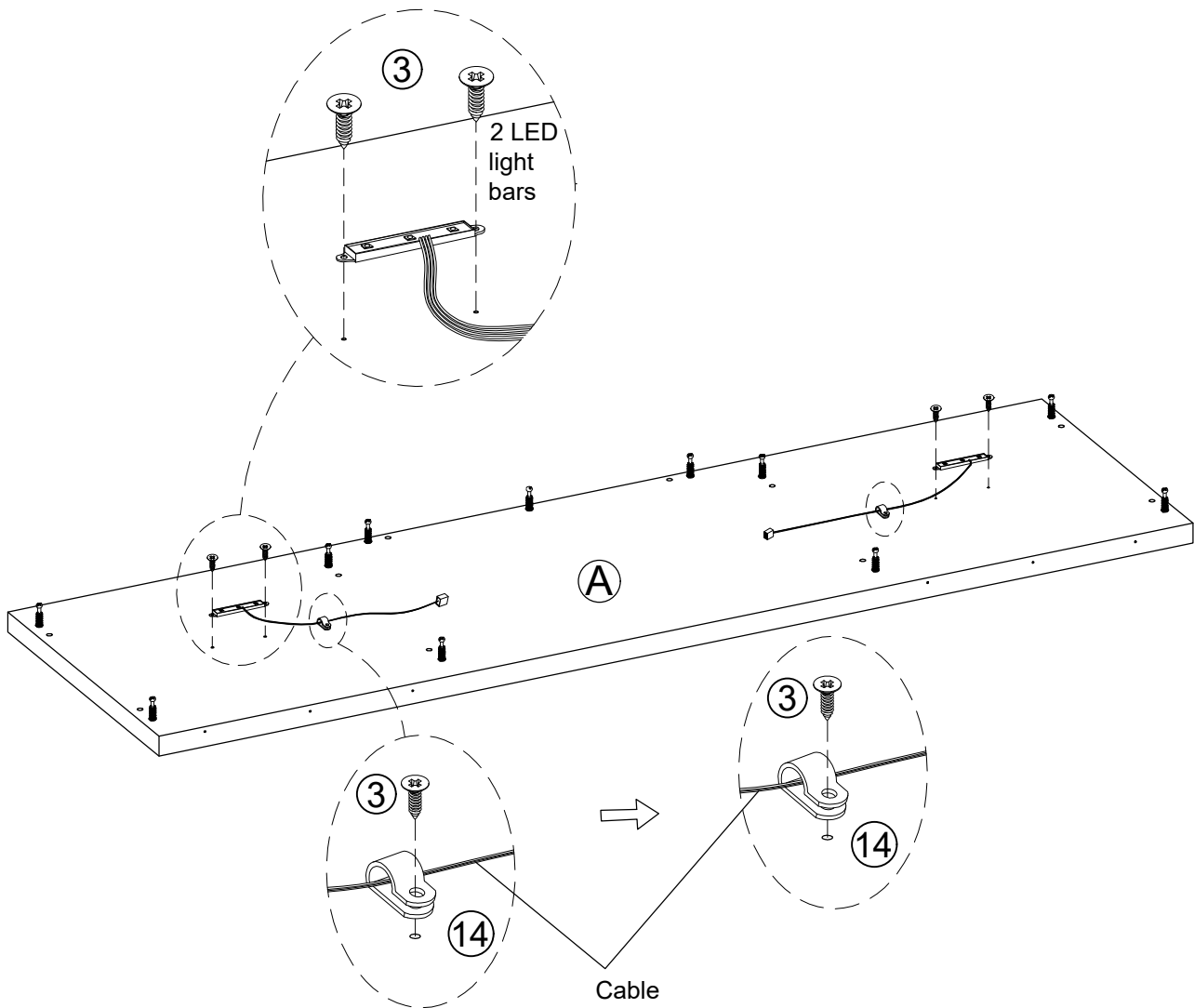

STEP 9

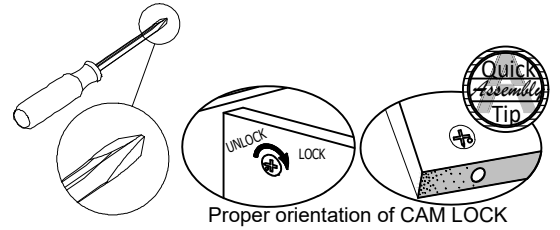
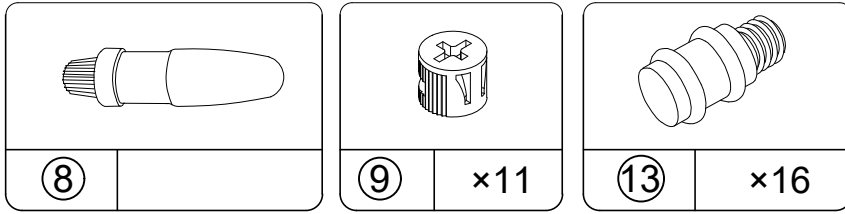

- 9.1 Attach (A) into (C) x 2, (D), (E) with (9) as illustrated.
 9.2 Insert (13) into (C) x 2, (D), (E) as illustrated.

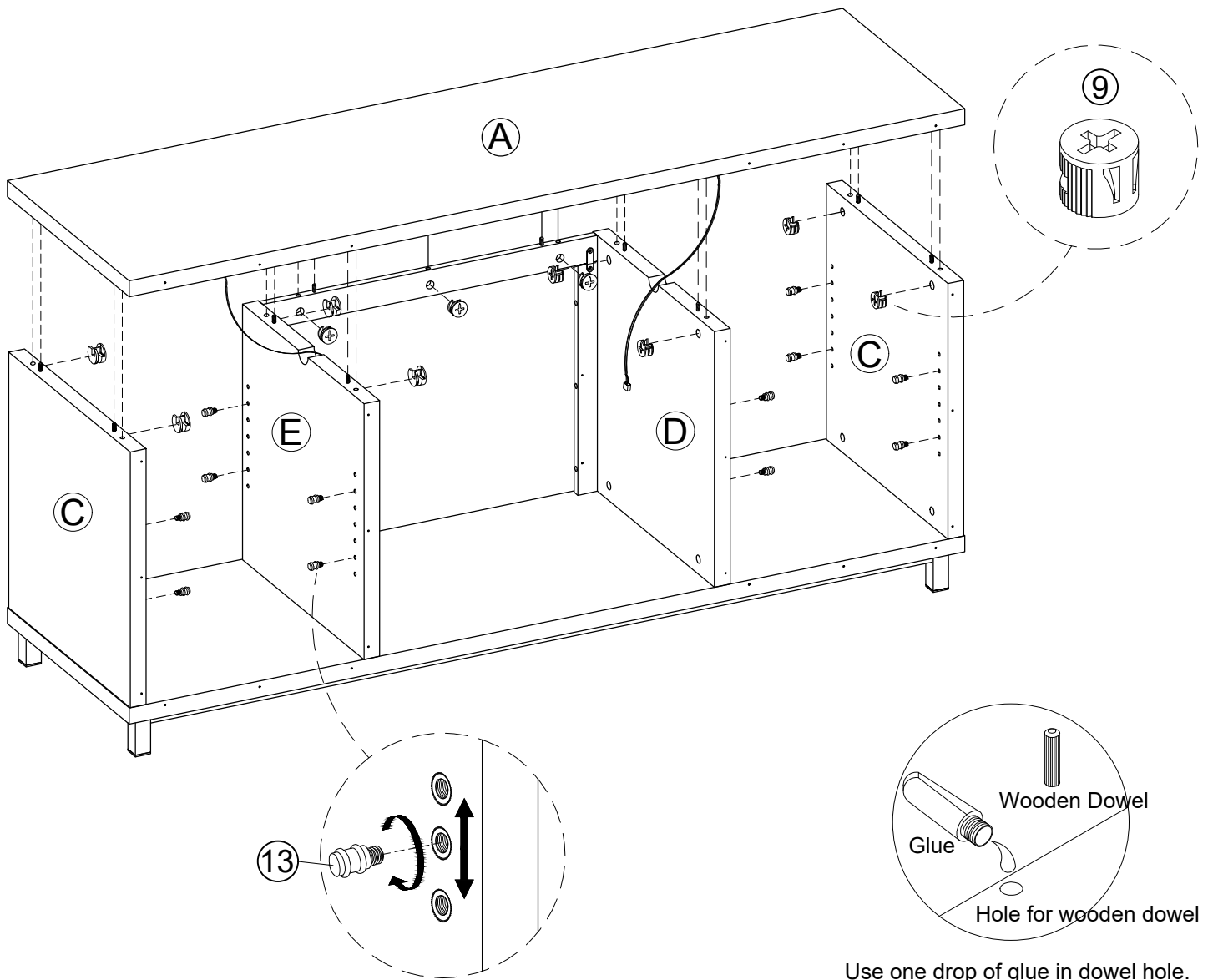

Use one drop of glue in dowel hole.

STEP 10

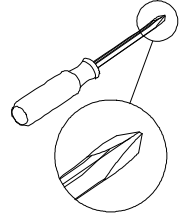
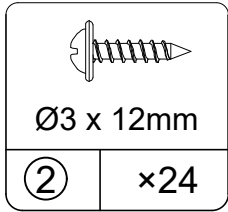

10.1 Attach (K) into (A), (B), (C), (D), (E) with (2) as illustrated.

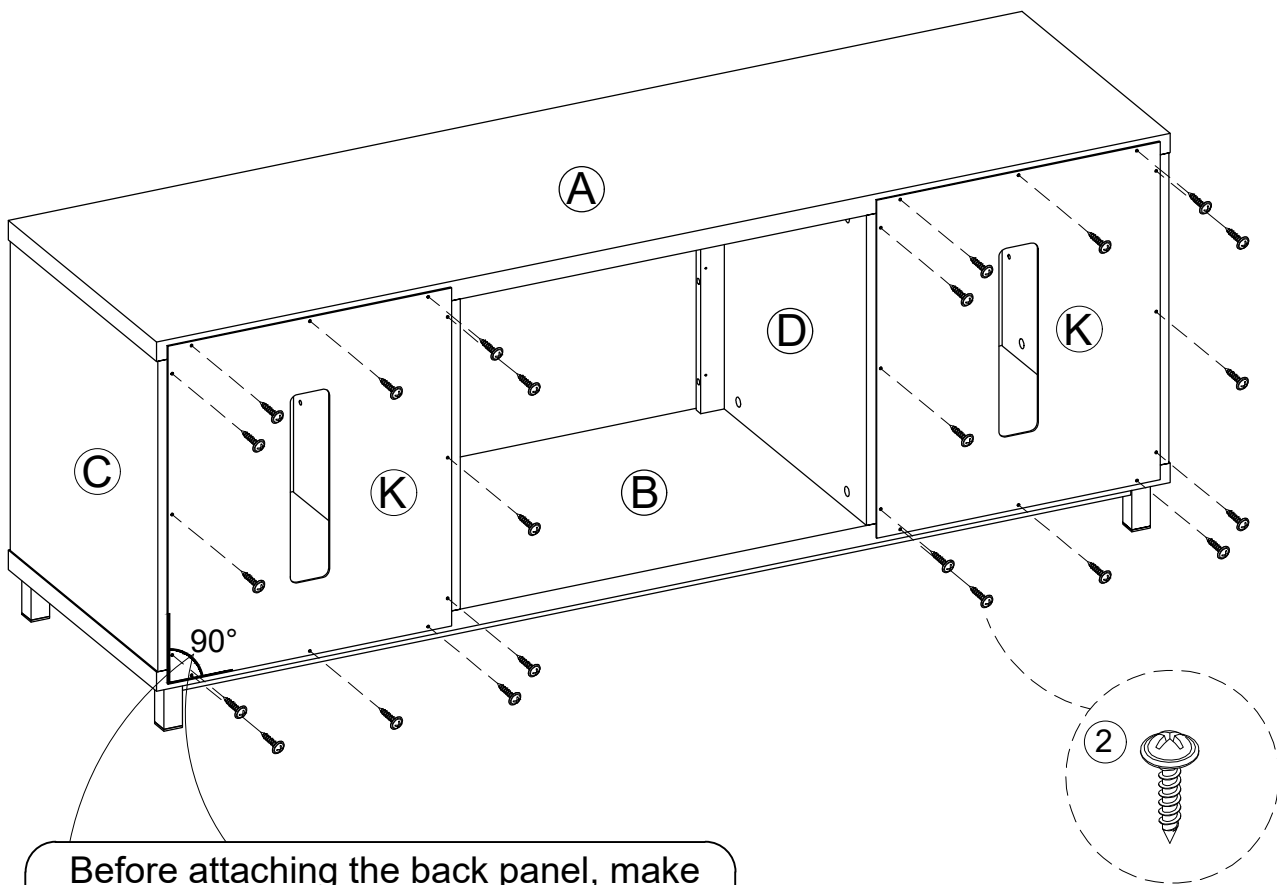

Before attaching the back panel, make sure that it is square to the unit .

STEP 11

11.1 Install the fireplace insert (FA23V60L-C8) as shown below. Insert the LED light as shown below.

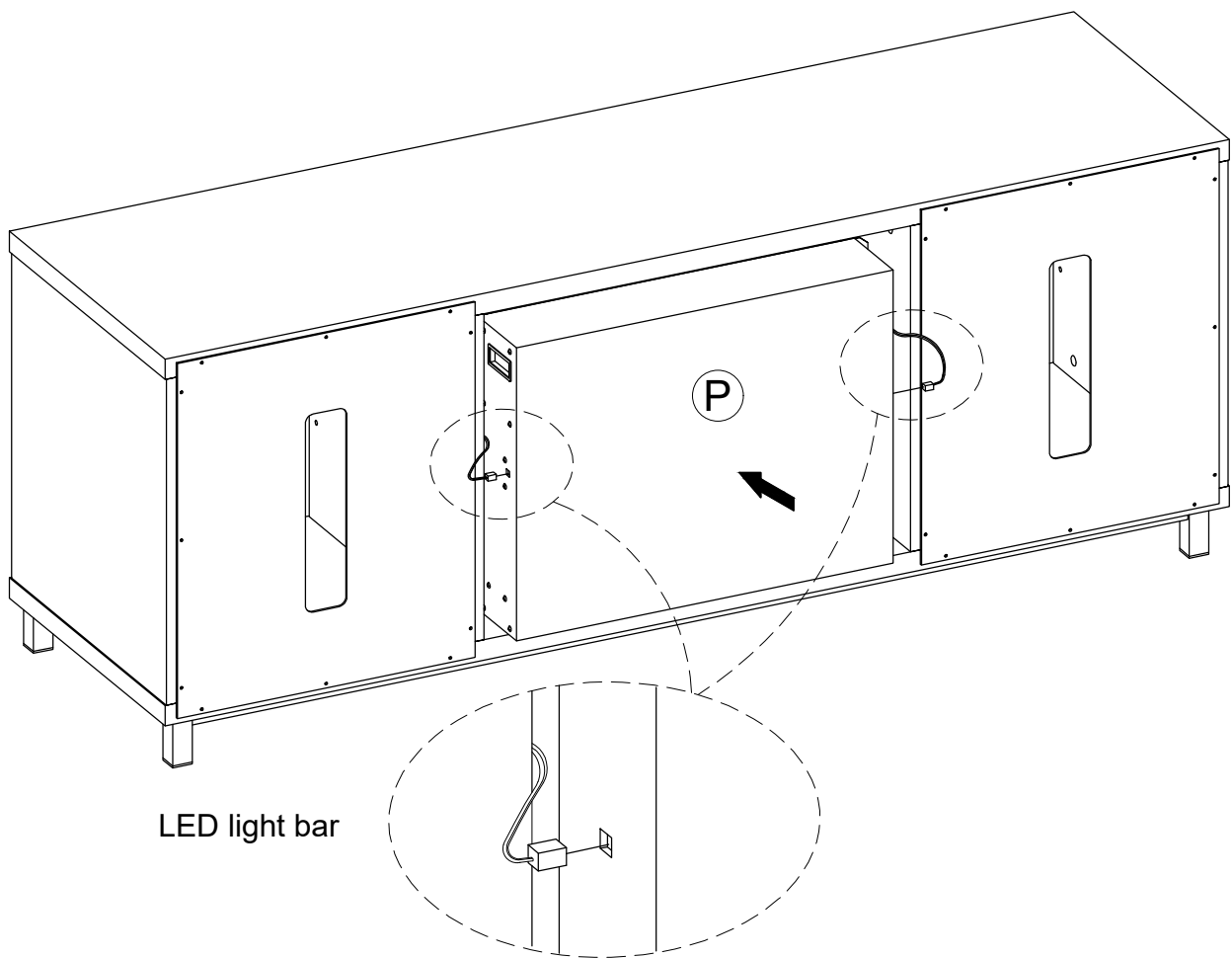

STEP 12

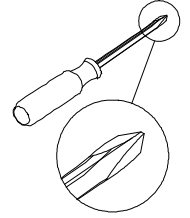
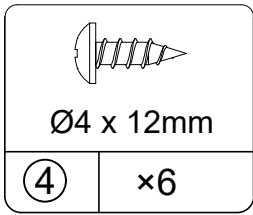

12.1 Attach (P) into (H), (G) with (4) as illustrated.

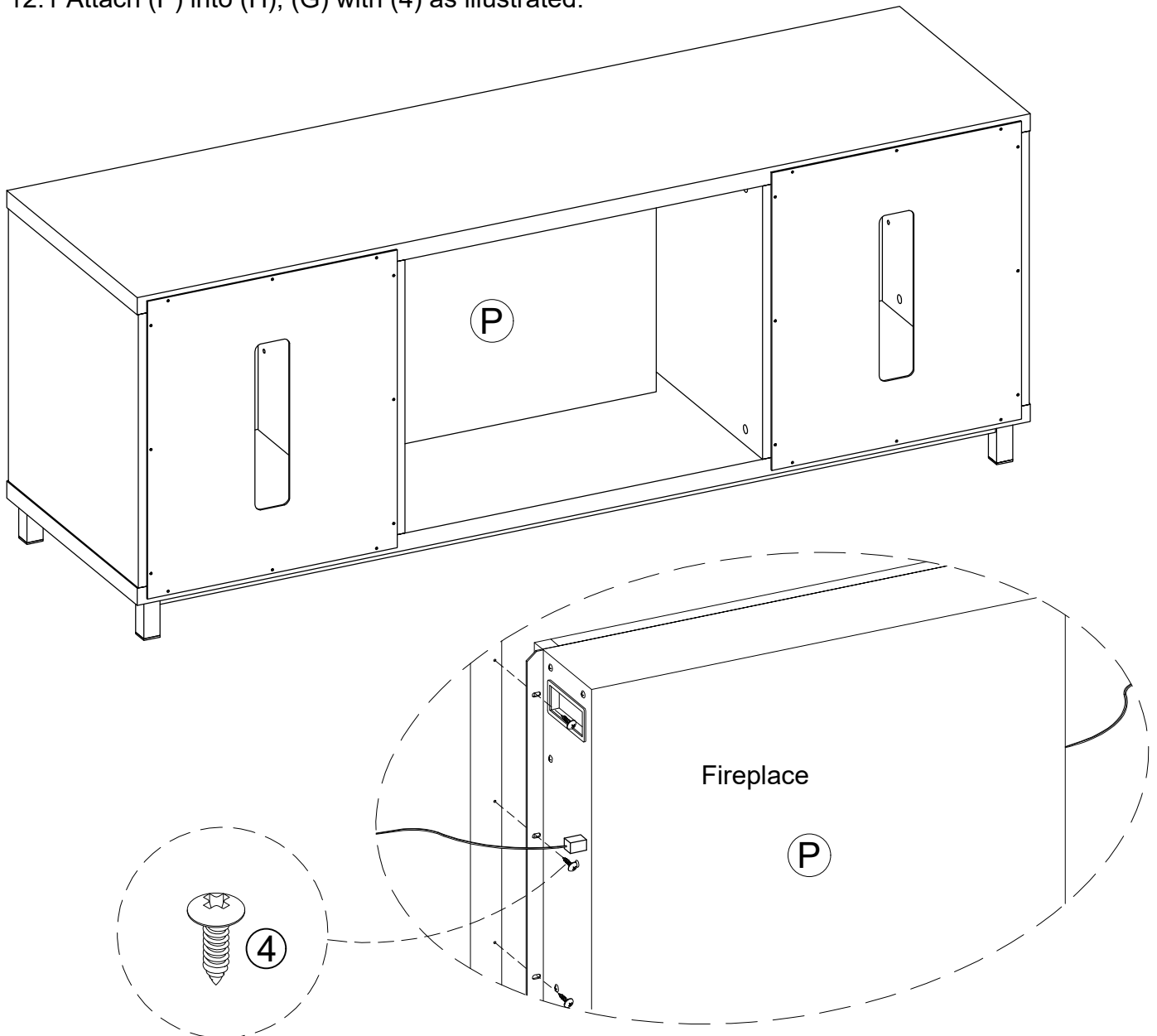

STEP 13

13.1 Insert (L) into (C) x 2, (D), (E) as illustrated.

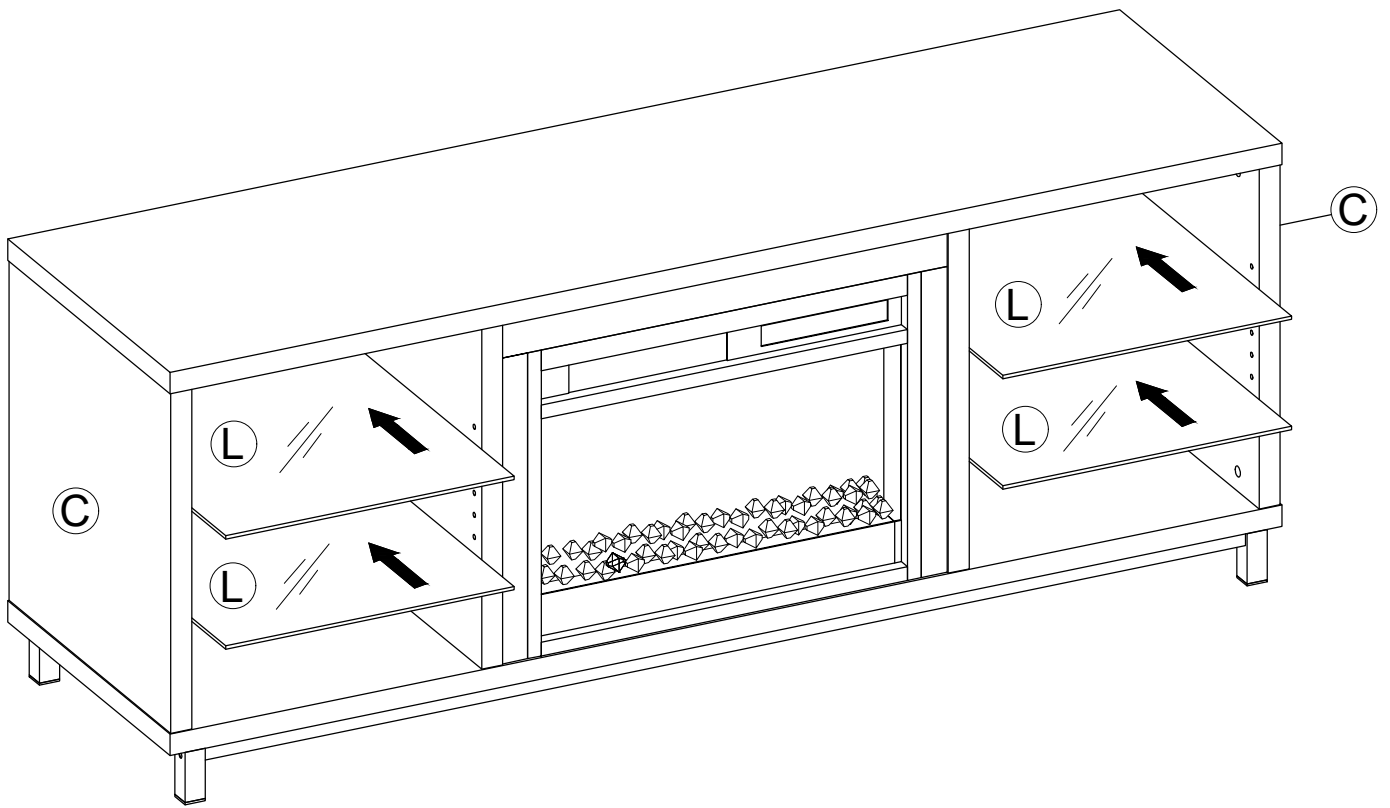

STEP 14

BEFORE CONNECTING THE UNIT TO A WALL ELECTRIC OUTLET

Please carefully read and follow instructions and safety warnings in “Fireplace Homeowners Operating Manual” to operate your fireplace.

WARNING

IF THE INFORMATION IN THE FIREPALCE OPERATING MANUAL IS NOT FOLLOWED, AN ELECTRIC SHOCK OR FIRE MAY RESULT IN PROPERTY DAMAGE, PERSONAL INJURY, OR LOSS OF LIFE.

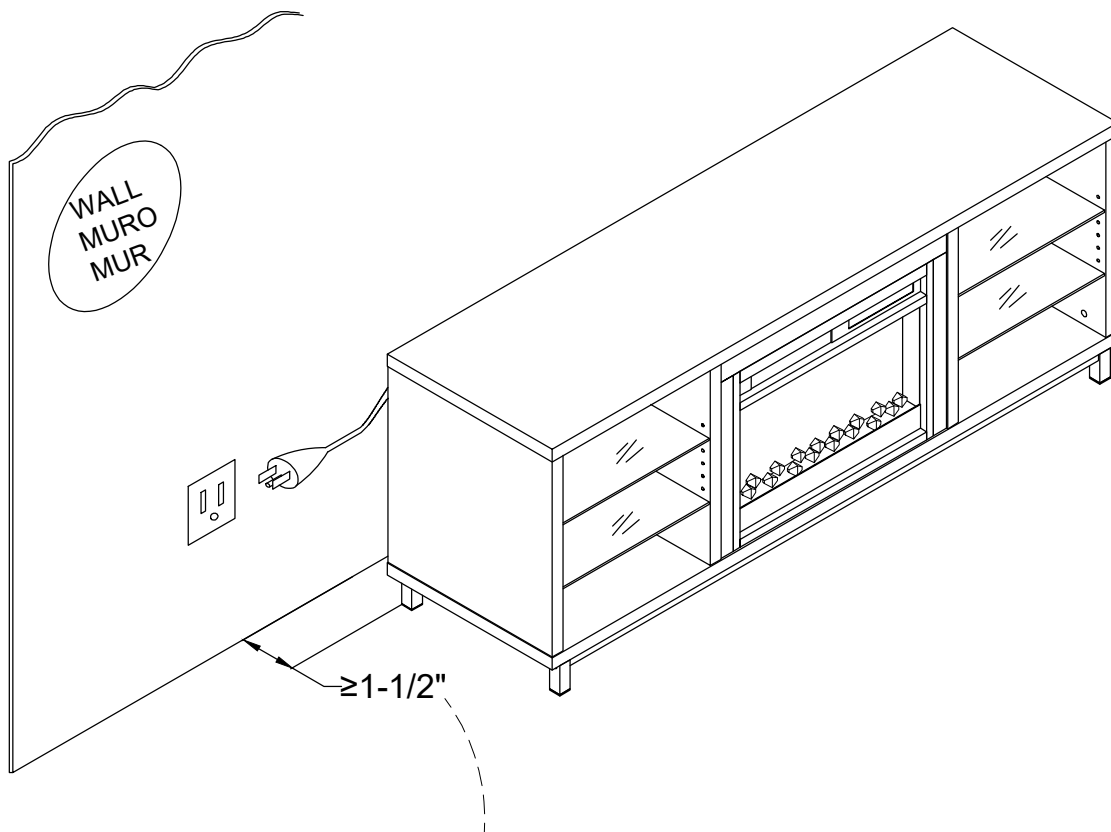

To allow proper heater ventilation, this unit must be located a minimum of 1-1/2" away from a back wall.

Maximum Loads

This unit has been designed to support the maximum loads shown. Exceeding these load limits could cause sagging, instability, product collapse, and/or serious injury.

Notice: Please apply the TV warning label to your unit so you'll always have the model's weight and TV size limits.

Maximum TV size: 70" flat screen

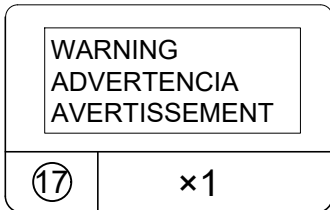

Accommodates most flat panel TVs up to 70", 120 lbs./54.4 kgs MAX.

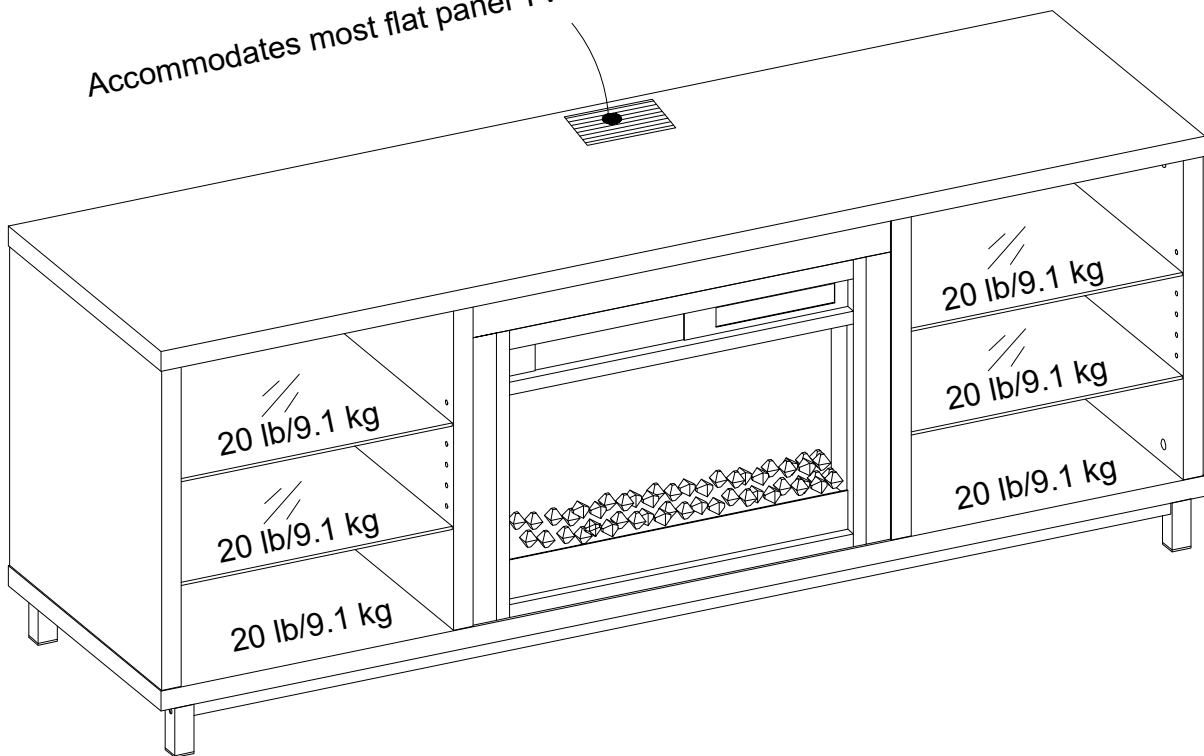

Certificate of Conformity

1. This certificate applies to the Dorel Home Furnishings, Inc. product identified by this instruction manual.
2. This certificate applies to compliance of this product with the CPSC Ban on Lead-Containing Paint (16 CFR 1303).
3. This product is distributed by: Dorel Home Furnishings, Inc.
410 East First Street South
Wright City, MO 63390
636-745-3351
4. Site of Manufacture: Binh Duong, Viet Nam.
5. See front page of instruction manual for date of manufacture.

Register your product to receive the following:



- * New trend details - sneak peek on what's new
- * Surveys - have a voice within our community
- * Exclusive deals and discount codes
- * Quick and easy replacement part service

To register your product, visit ameriwoodhome.com

5 Star Rating



Visit your local retailer's website, rate your purchased product and leave us some feedback!

We would like to extend a big "Thank You" to all of our customers for taking the time to assemble this Ameriwood Home product, and to give us your valuable feedback.

Thank You!

Couverture Avant

CE LIVRET D'INSTRUCTION CONTIENT DES INFORMATIONS **IMPORTANTES** SUR LA SÉCURITÉ. VEUILLEZ LIRE ET GARDER POUR UNE RÉFÉRENCE FUTURE

Ne retournez pas ce produit! Contactez notre équipe de service à la clientèle amicale d'abord pour obtenir de l'aide.

Appelez-nous: 1-800-489-3351 (sans frais) du Lundi au Vendredi de 9h à 17h Heure Centrale

Visitez: www.ameriwoodhome.com

ATTENTION

Le meuble peut basculer et causer des blessures graves ou la mort.

Ancrer le meuble à une planche murale dans le mur (si indiqué).

Ne laissez pas les enfants grimper sur le meuble.

Placez les articles lourds sur les étagères ou dans les tiroirs inférieurs.

Astuces Utiles (page 2)

- Ouvrez votre article dans la zone que vous prévoyez de le garder pour moins de levage lourd
- Identifier, trier et compter les pièces avant d'essayer d'assembler
- Les goujons de compression sont taraudés avec un Marteau
- Les glissières sont marquées d'un R (droit) et d'un L (gauche) pour un bon placement
- Assurez-vous toujours de faire face la pointe situé sur le haut de la Serrure de Came vers le bord extérieur
- Utiliser tous les clous fournis pour le panneau arrière et les répartir également
- Le panneau arrière doit être utilisé pour vous assurer que votre appareil est robuste
- N'utilisez pas de produits chimiques agressifs ou de nettoyeurs abrasifs sur cet appareil
- Ne jamais pousser, tirer, ou faire glisser votre meuble

Avant de Commencer (page 3)

- Lisez attentivement chaque étape et suivez le bon ordre
- Séparez et comptez toutes vos pièces et matériaux
- Donnez-vous suffisamment de place pour l'assemblage
- Avoir les outils suivants: tournevis à tête plate, #2 tournevis Phillips, et Marteau
- Attention: Si vous utilisez une perceuse électrique ou un tournevis électrique pour visser, veillez à ralentir et arrêter lorsque la vis est bien serrée. Le non-respect de cette consigne peut endommager la vis.

Système de Fixation de Came (page 3)

Ce Système de Fixation de Came sera utilisé tout au long de l'assemblage.

Page 4,5 & 6: Identification du conseil

Pas la taille réelle

- (A) ÉTAGÈRE SUPÉRIEURE
- (B) PANNEAU INFÉRIEUR
- (C) PANNEAU LATÉRAL
- (D) CLOISON GAUCHE
- (E) CLOISON DROITE
- (F) TABLIER SUPÉRIEUR
- (G) RAIL LATÉRAL GAUCHE
- (H) RAIL CTÉ DROIT
- (J) PIED
- (K) PANNEAU ARRIÈRE
- (L) TABLETTE EN VERRE
- (M) CADRE DE PIED EN MÉTAL
- (N) TUBE DE SUPPORT
- (P) FOYER

Page 7-8: Liste des pièces

Taille actuelle

- (1) Cheville en bois
- (2) Vis
- (3) Vis
- (4) Vis
- (5) Vis
- (6) Boulon
- (7) Boulon

Pas de taille réelle

- (8) (8)Colle
- (9) Serrure à came
- (10) Boulon à came
- (11) Clé hexagonale
- (12) Plaque de métal
- (13) Support d'étagère
- (14) Pince à fil
- (15) Rondelle élastique
- (16) Rondelle
- (17) Étiquette d'avertissement

Page 9

- 1.1 Boulon à came (10) dans (A), (B) comme illustré.
- 1.2 Insérez (1) dans (C) x 2 comme illustré.

Page 10

- 2.1 Insérez (1) dans (D), (E), (H), (F) et (G) comme illustré.

Page 11

- 3.1 Fixez (N) x 2 dans (B) avec (7), (15) et (16) comme illustré.

Remarque : NE PAS serrer le boulon pour garantir la réussite des assemblages à cette étape.

Page 12

- 4.1 Fixez (M) dans (B) avec (7), (15) et (16) comme illustré.
- 4.2 Fixez (M) dans (N) avec (6), (15) et (16) comme illustré.

Remarque : NE PAS serrer le boulon pour assurer l'assemblage avec succès à cette étape.

Page 13

- 5.1 Fixez (J) dans (B) comme illustré.

Remarque : Serrez tous les boulons pour fixer l'unité dans cette étape d'assemblage.

* Si le sol est inégal, ajustez les niveleurs de pied en les faisant pivoter à votre hauteur préférée.

Une fois le bureau debout et les niveleurs ajustés, assurez-vous que l'unité ne vacille pas.

Page 14

- 6.1 Attachez (G) dans (D) avec (5) comme illustré.
- 6.2 Fixez (H) dans (E) avec (5) comme illustré.
- 6.3 Fixez (C) x 2, (D), (E) dans (B) avec (9) comme illustré.

Page 15

- 7.1 Fixez (F) dans (G), (H) avec (12), (3) comme illustré.

Page 16

2 barres lumineuses à LED sont emballées dans la petite boîte intérieure.

Cette petite boîte intérieure est emballée dans la boîte en carton d'insertion de cheminée.

Page 17

9.1 Fixez (A) dans (C) x 2, (D), (E) avec (9) comme illustré.

9.2 Insérez (13) dans (C) x 2, (D), (E) comme illustré.

Page 18

10.1 Attachez (K) dans (A), (B), (C), (D), (E) avec (2) comme illustré.

Conseil de montage : Avant de fixer le panneau arrière, assurez-vous qu'il est à l'équerre de l'unité.

Page 19

11.1 Installez le foyer encastrable (FA23V60L-C8) comme illustré ci-dessous. Insérez la lumière LED comme indiqué ci-dessous.

Page 20

12.1 Fixez (P) dans (H), (G) avec (4) comme illustré.

Page 21

13.1 Insérez (L) dans (C) x 2, (D), (E) comme illustré.

Page 22

AVANT DE BRANCHER L'APPAREIL À UNE PRISE ÉLECTRIQUE MURALE

Veuillez lire attentivement et suivre les instructions et les avertissements de sécurité du « Manuel d'utilisation du foyer pour les propriétaires de foyer » pour faire fonctionner votre foyer.

ATTENTION

SI LES INFORMATIONS CONTENUES DANS LE MANUEL D'UTILISATION DU FIREPALCE NE SONT PAS SUIVI, UN CHOC ÉLECTRIQUE OU UN INCENDIE POURRAIT ENTRAÎNER DES DOMMAGES MATÉRIELS, DES BLESSURES CORPORELLES OU LA MORT.

Attention : Pour permettre une ventilation adéquate du radiateur, cet appareil doit être situé à au moins 1-1/2 po d'un mur arrière.

Page 23

Cette unité a été conçue pour supporter les charges maximales indiquées. Le dépassement de ces limites de charge peut provoquer un affaissement, une instabilité, un effondrement du produit et/ou des blessures graves.

Remarque : Appliquez l'étiquette d'avertissement du téléviseur sur votre appareil afin d'avoir toujours les limites de poids et de taille du téléviseur du modèle.

Taille maximale du téléviseur : écran plat 70".

Page 24

Enregistrez votre produit pour recevoir les éléments suivantes:

- * Détails sur les nouvelles tendances - un aperçu sur les nouveautés
- * Sondages - avoir une voix au sein de notre communauté
- * Offres exclusives et codes promo
- * Service de pièces de rechange rapide et facile

Pour enregistrer votre produit, visitez ameriwoodhome.com

5 Étoiles

Visitez le site Web de votre détaillant local, évaluez le produit que vous avez acheté et laissez-nous vos commentaires !

Nous tenons à offrir un grand "Merci" à tous nos clients pour avoir pris le temps d'assembler ce produit "Ameriwood Home", et de nous donner vos commentaires précieux.

Merci

Cubierta Delantera

Este libro de instrucciones contiene información **IMPORTANTE** de seguridad. Por favor lea y manténgalo para referencia en el futuro.

No Regrese este producto! Comuníquese con nuestro amigoso equipo de servicio al cliente para obtener ayuda.

Llámenos al: 1-800-489-3351 (Gratis) Lunes - Viernes 9am - 5pm CST

Visitar: www.ameriwoodhome.com

PRECAUCION

Este mueble puede volcarse y causar graves heridas y/o muerte.

Anclar el mueble a un poste de madera en la pared (si esto se requiere).

No Permita que los niños monten el mueble.

Mantenga los artículos más pesados en los cajones de abajo.

Consejos Útiles (página 2)

- Abra su artículo en el área donde usted planea utilizarlo para evitar levantar y moverlo menos
- Identificar, ordenar y contar las piezas antes de intentar ensamblar
- Las clavijas de compresión se golpean con un martillo
- Las diapositivas están marcadas con una R (derecha) y L (izquierda) para la colocación correcta
- Asegúrese de que siempre este el punto localizado en la parte superior de bloqueador de leva este volteado hacia borde exterior
- Utilizar todos los clavos para el panel de atrás y distribuirlos por igual
- El panel de atrás debe utilizarse para asegurarse de que la unidad quede fija y firme
- No use químicas fuertes ni limpiadores abrasivos en este artículo
- Nunca empuje, tire ni arrastre los muebles

Antes de Que Empieces (página 3)

- Lea cuidadosamente cada paso y siga el orden correcto

- Separar y contar todas sus piezas y hardware

- Dése suficiente espacio para el proceso de ensamble

- Tenga las siguientes herramientas: destornillador de cabeza plana, #2 cabeza Phillips

Destornillador y martillo

- Precaución: Si usa un taladro electrónico o un destornillador eléctrico para atornillar, por favor asegúrese que deje de atornillar cuando el tornillo este apretado. Fallar hacer esto puede causar barrer el tornillo.

Sistema de fijar el bloqueo de leva (página 3)

Esta sistema de fijar el bloqueo de leva sera usado en todo el proceso ensamble.

Página 4 & 5: Identificación de la Junta
No es la talla actual

- (A) ESTANTE SUPERIOR
- (B) PANEL INFERIOR
- (C) PANEL LATERAL
- (D) PARTICIÓN IZQUIERDA
- (E) PARTICIÓN DERECHA
- (F) DELANTAL DE ESTANTE SUPERIOR
- (G) RIEL LATERAL IZQUIERDO
- (H) RIEL LADO DERECHO
- (J) PIE
- (K) PANEL TRASERO
- (L) ESTANTE DE CRISTAL
- (M) MARCO DE PIE DE METAL
- (N) TUBO DE SOPORTE
- (P) CHIMENEA

Página 7-8: Lista de
Tamaño real

- (1) Taco de madera
- (2) Tornillo
- (3) Tornillo
- (4) Tornillo
- (5) Tornillo
- (6) Perno
- (7) Perno

No es la talla actual

- (8) Pegamento
- (9) Bloqueo de leva
- (10) Perno de leva
- (11) Llave hexagonal
- (12) Placa de metal
- (13) Soporte de balda
- (14) Clip de alambre
- (15) Arandela de resorte
- (16) Arandela
- (17) Etiqueta de advertencia

Página 9

- 1.1 Perno de leva (10) en (A), (B) como se ilustra.
- 1.2 Inserte (1) en (C) x 2 como se ilustra.

Página 10

- 2.1 Inserte (1) en (D), (E), (H), (F) y (G) como se ilustra.

Página 11

- 3.1 Conecte (N) x 2 en (B) con (7), (15) y (16) como se ilustra.

Nota: NO apriete el perno para asegurarse de que los ensamblajes se realicen correctamente en este paso.

Página 12

- 4.1 Conecte (M) en (B) con (7), (15) y (16) como se ilustra.
- 4.2 Conecte (M) en (N) con (6), (15) y (16) como se ilustra.

Nota: NO apriete el perno para asegurar que el ensamblaje sea exitoso en este paso.

Página 13

- 5.1 Conecte (J) en (B) como se ilustra.

Nota: Apriete todos los pernos para asegurar la unidad en este paso de ensamblaje.

* Si el suelo es irregular, ajuste los niveladores de pie girándolos a su altura preferida. Una vez que el escritorio esté de pie y los niveladores estén ajustados, asegúrese de que la unidad no se tambalee.

Página 14

- 6.1 Conecte (G) en (D) con (5) como se ilustra.
- 6.2 Conecte (H) en (E) con (5) como se ilustra.
- 6.3 Conecte (C) x 2, (D), (E) en (B) con (9) como se ilustra.

Página 15

- 7.1 Conecte (F) en (G), (H) con (12), (3) como se ilustra.

Página 16

En la pequeña caja interior se embalan 2 barras de luz LED.

Esta pequeña caja interior viene empaquetada en la caja de cartón de inserción para chimenea.

Página 17

9.1 Conecte (A) en (C) x 2, (D), (E) con (9) como se ilustra.

9.2 Inserte (13) en (C) x 2, (D), (E) como se ilustra.

Página 18

10.1 Conecte (K) en (A), (B), (C), (D), (E) con (2) como se ilustra.

Consejo de montaje: antes de colocar el panel posterior, asegúrese de que esté en escuadra con la unidad.

Página 19

11.1 Instale el inserto de chimenea (FA23V60L-C8) como se muestra a continuación. Inserte la luz LED como se muestra a continuación.

Página 20

12.1 Conecte (P) en (H), (G) con (4) como se ilustra.

Página 21

13.1 Inserte (L) en (C) x 2, (D), (E) como se ilustra.

Página 22

ANTES DE CONECTAR LA UNIDAD A UNA TOMA ELÉCTRICA DE PARED

Lea atentamente y siga las instrucciones y las advertencias de seguridad en el "Manual de funcionamiento del propietario de la chimenea" para hacer funcionar su chimenea.

ADVERTENCIA

SI NO SE CUMPLE LA INFORMACIÓN DEL MANUAL DE FUNCIONAMIENTO DE FIREPALCE, UNA DESCARGA ELÉCTRICA O UN INCENDIO PUEDEN PROVOCAR DAÑOS A LA PROPIEDAD, LESIONES PERSONALES O LA PÉRDIDA DE LA VIDA.

Precaución: Para permitir la ventilación adecuada del calentador, esta unidad debe ubicarse a una distancia mínima de 1-1 / 2 "de una pared trasera.

Página 23

Esta unidad ha sido diseñada para soportar las cargas máximas que se muestran. Exceder estos límites de carga podría causar flacidez, inestabilidad, colapso del producto y / o lesiones graves.

Aviso: aplique la etiqueta de advertencia de TV a su unidad para que siempre tenga los límites de peso y tamaño de TV del modelo.

Tamaño máximo de TV: pantalla plana de 70 ".

Página 24

Registre su producto para recibir lo siguiente:

- * Detalles de nuevas tendencias - Vistazo a lo nuevo
- * Encuestas - aloc su voz entre su comunidad
- * Códigos de ofertas y descuentos exclusivos
- * Fácil y rápido servicio de partes de remplace

Para registrar su producto, visite ameriwoodhome.com - Clasificación de 5 estrellas

Visite el sitio web de su distribuidor local, califique el producto que compró y déjenos sus comentarios.

Nos gustaría enviar un gran "Agradecimiento" a todos nuestros clientes por tomarse el tiempo de ensamblar este producto de Ameriwood Home, y por darnos sus valiosos comentarios.

Gracias