

# 7531396COM

## 1 Door Storage Cabinet

systembuild™  
EVOLUTION

Date of Purchase \_\_\_/\_\_\_/\_\_\_  
Lot Number:

B347531396COM05GO

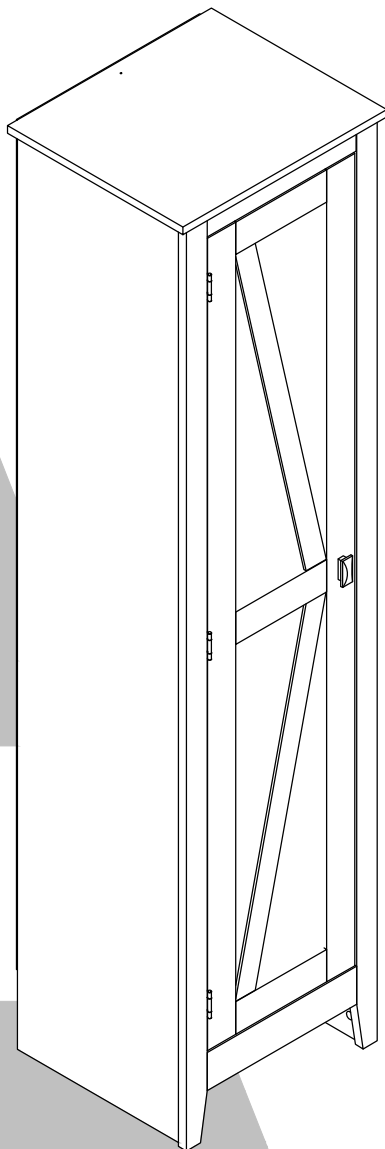

THIS INSTRUCTION BOOKLET CONTAINS **IMPORTANT** SAFETY INFORMATION. PLEASE READ AND KEEP FOR FUTURE REFERENCE.

### Do Not Return This Product!

Contact our customer service team for help first.

**Call:** 1-800-489-3351 (toll free)

Monday-Friday 9am - 5pm CST

**Visit:** [www.ameriwoodhome.com](http://www.ameriwoodhome.com)

## WARNING

- Unit can tip over causing severe injury or death.
- Anchor unit to stud in wall (if instructed to).
- Do Not allow children to climb on unit.
- Put heavy items on lower shelves or drawers.

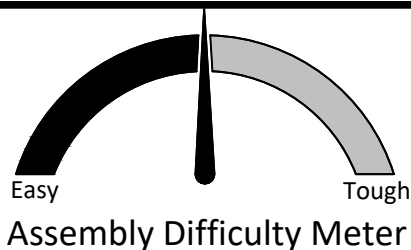

Follow Ameriwood Home



## Contact Us!

### Do NOT return this product!

Contact our friendly customer service team first for help.

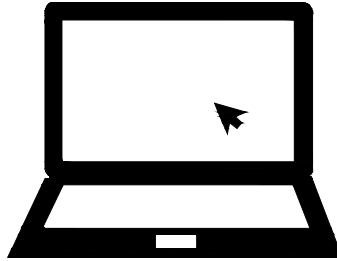
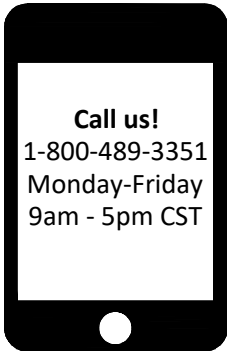

Visit [ameriwoodhome.com](http://ameriwoodhome.com)

Assembly Tips



## Helpful Hints

PEOPLE NEEDED FOR ASSEMBLY: 2

ESTIMATED ASSEMBLY TIME: 1 HOUR

- Open your item in the area you plan to keep it to avoid excessive heavy lifting.
- Identify, sort and count the parts before attempting assembly.
- Compression dowels are lightly tapped in with a hammer.
- Slides are labeled with a **R** (right) and **L** (left) for proper placement.
- Make sure to always face the point on the top of the Cam Lock towards the outer edge.
- Use all the nails provided for the back panel and spread them out equally.
- Back panel must be used to make sure your unit is sturdy.
- Do NOT use harsh chemicals or abrasive cleaners on this item.
- Never push, pull, or drag your furniture.

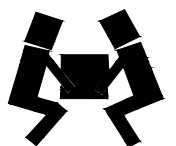
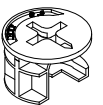
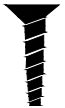

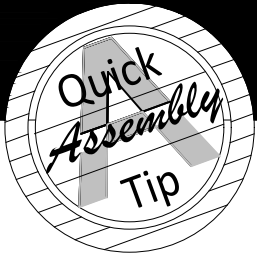

## Before You Start

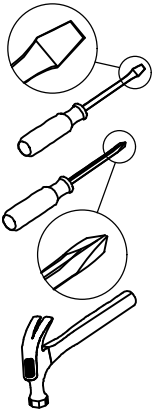

- ✓ Read through each step carefully and follow the proper order
- ✓ Separate and count all your parts and hardware
- ✓ Give yourself enough room for the assembly process
- ✓ Have the following tools: Flat Head Screwdriver, #2 Phillips Head Screwdriver and Hammer
- ✓ Caution: If using a power drill or power screwdriver for screwing, please be aware to slow down and stop when screw is tight. Failure to do so may result in stripping the screw.

## Cam Lock Fastening System

This Cam Lock Fastening System will be used throughout the assembly process.

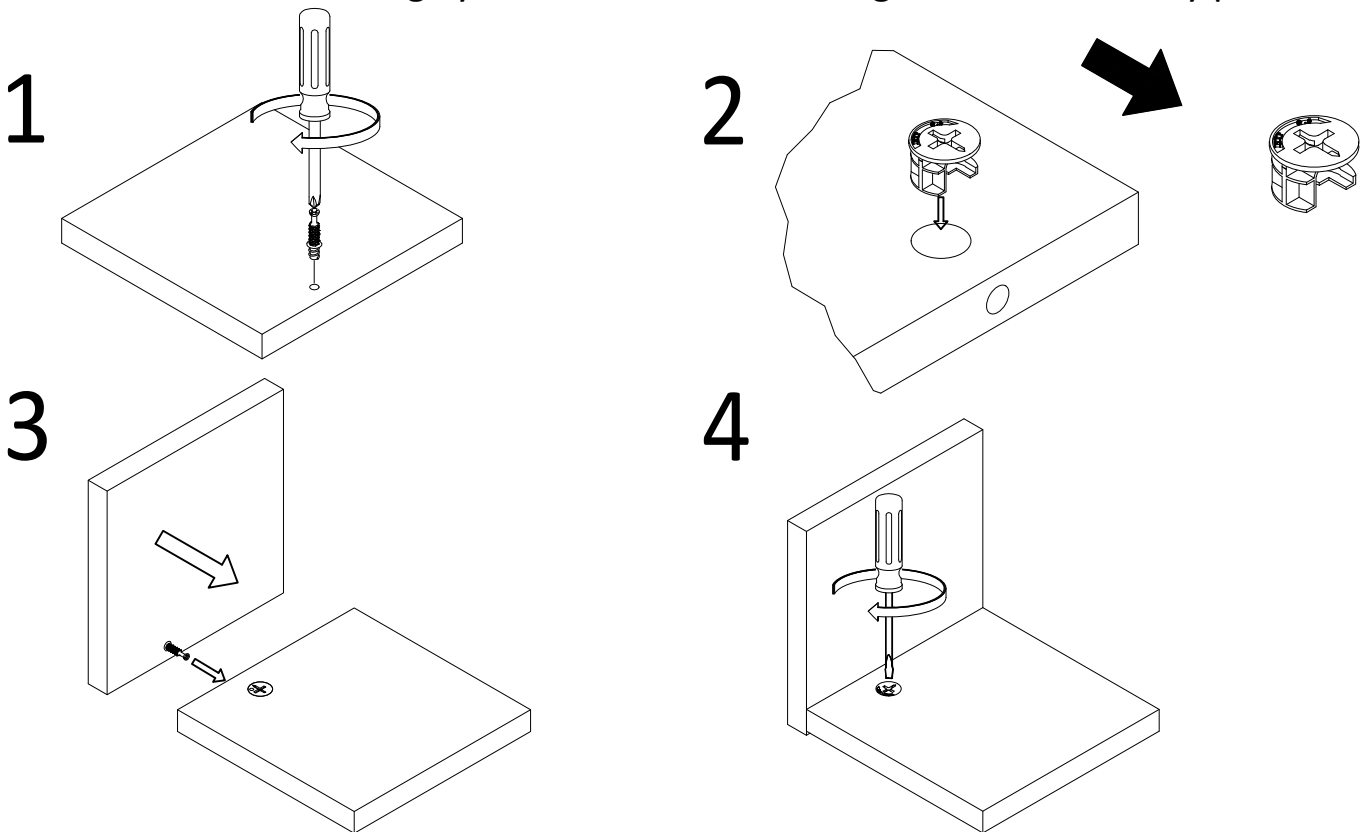

# Board Identification

Not actual size

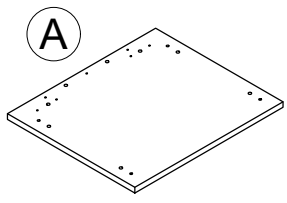

**A**  
TOP  
T7531396011GO  
QTY: 1 PC

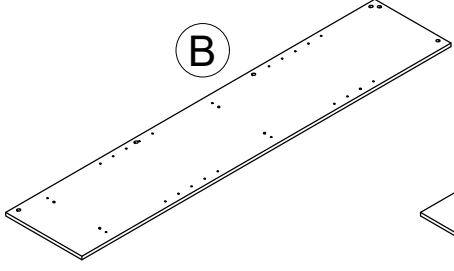

**B**  
LEFT SIDE PANEL  
T7531396021GO  
QTY: 1 PC

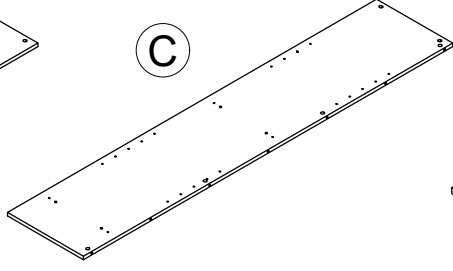

**C**  
RIGHT SIDE PANEL  
T7531396031GO  
QTY: 1 PC

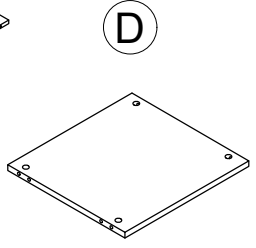

**D**  
FIXED SHELF  
T7531396040GO  
QTY: 1 PC

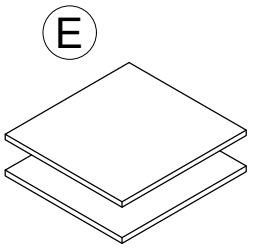

**E**  
ADJUSTABLE SHELF  
T7531396050GO  
QTY: 2 PCS

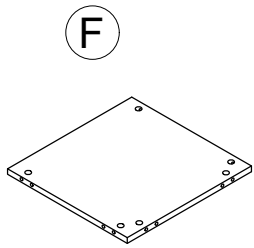

**F**  
BOTTOM  
T7531396061GO  
QTY: 1 PC

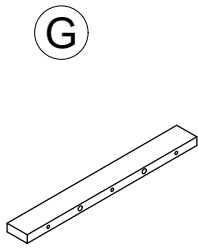

**G**  
TOP APRON  
T7531396070GO  
QTY: 1 PC

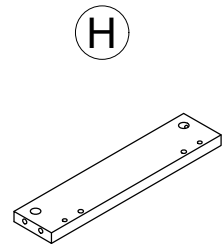

**H**  
LOWER APRON  
T7531396080GO  
QTY: 1 PC

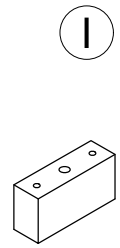

**I**  
WOOD BLOCK  
T7531396090GO  
QTY: 1 PC

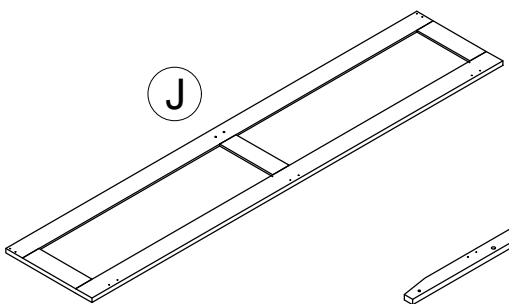

**J**  
DOOR  
T7531396100GO  
QTY: 1 PC

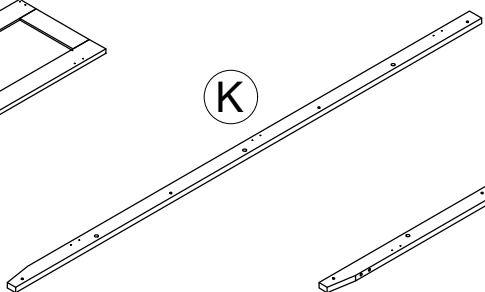

**K**  
LEFT APRON  
T7531396110GO  
QTY: 1 PC

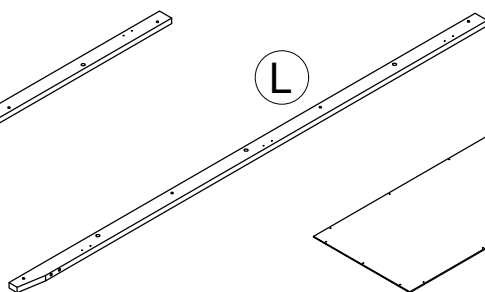

**L**  
RIGHT APRON  
T7531396120GO  
QTY: 1 PC

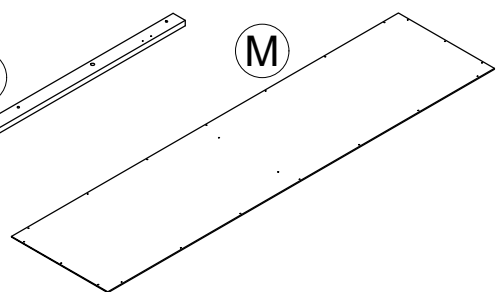

**M**  
BACK PANEL  
T7531396131GO  
QTY: 1 PC

# Board Identification

Not actual size

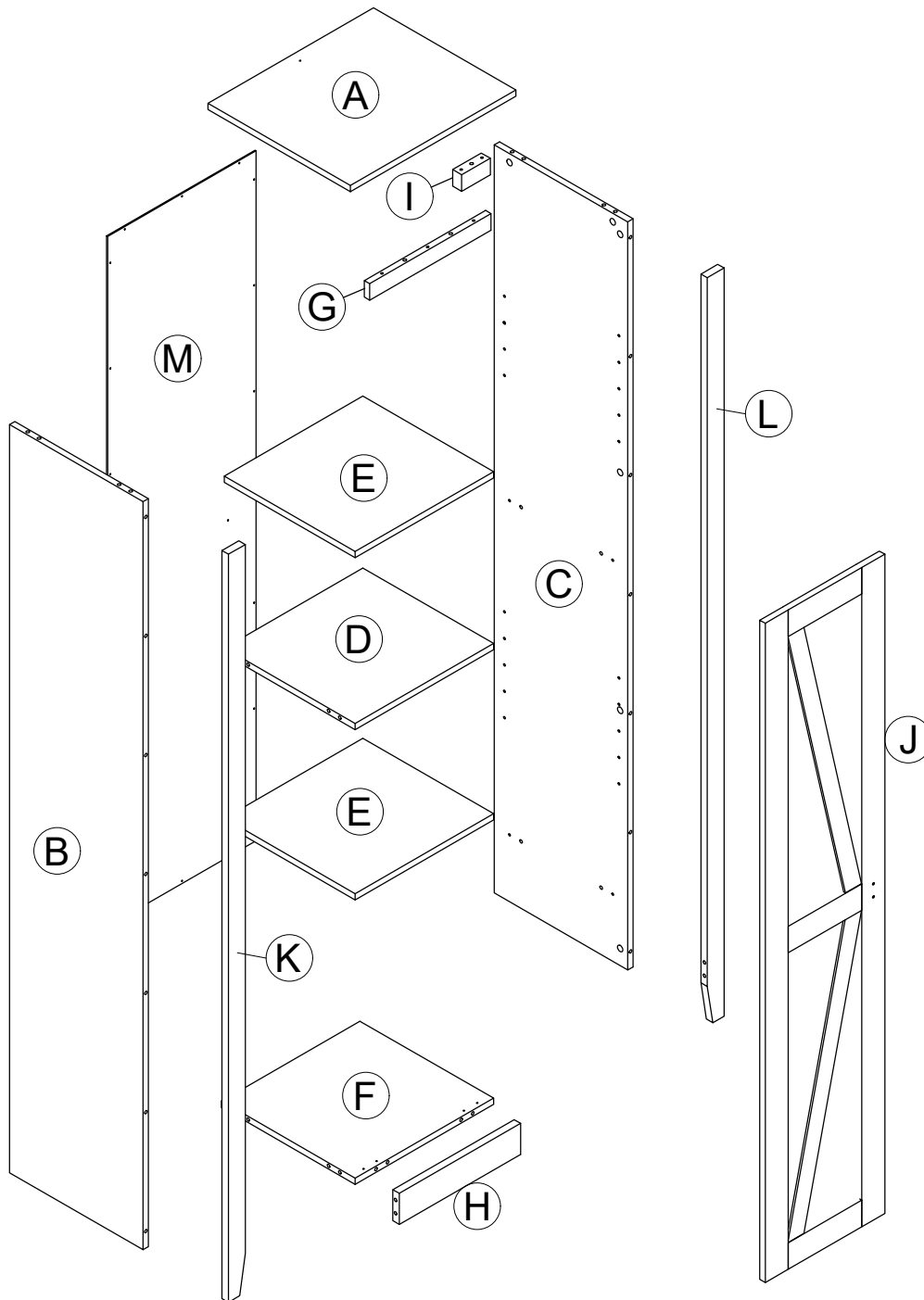

# Part List

## Actual Size

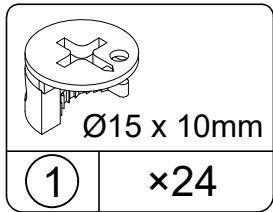

CAM LOCK  
TGO2100

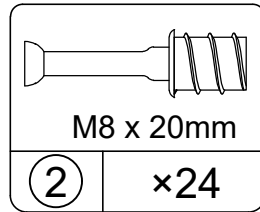

CAM BOLT  
TGO2000

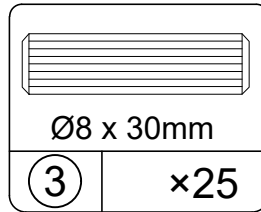

WOOD DOWEL  
TGO2900

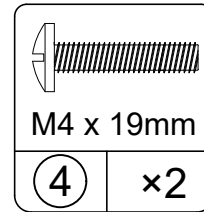

BOLT  
TGO1608

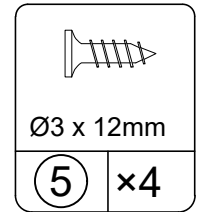

SCREW  
TGO1012

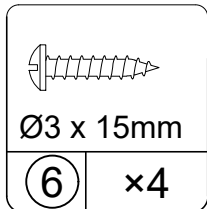

SCREW  
TGO1315

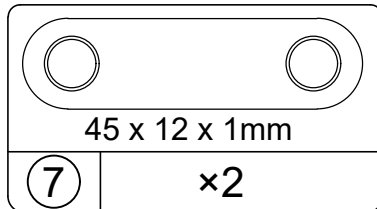

STRIKE PLATE  
TGO3525

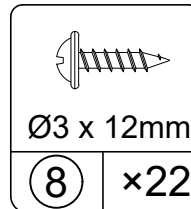

SCREW  
TGO1301

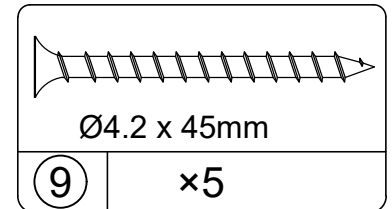

SCREW  
TGO1008

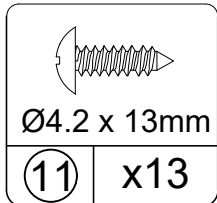

SCREW  
TGO1304

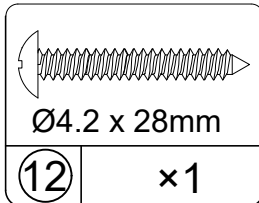

SCREW  
TGO1314

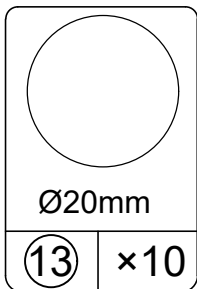

COVER  
TGO2232

## No Actual Size

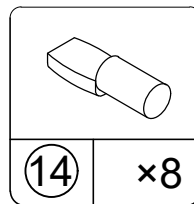

SHELF SUPPORT  
TGO2800

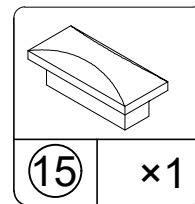

HANDLE  
TGO5510

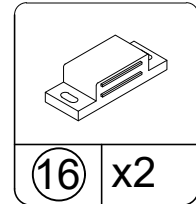

MAGNETIC CATCH  
TGO6512

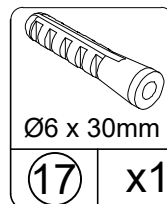

WALL ANCHOR  
TGO6501

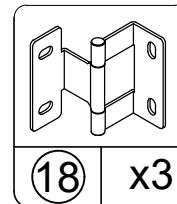

HINGE  
TGO4306

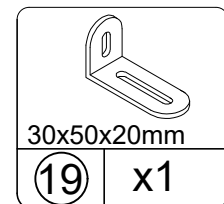

WALL BRACKET  
TGO3502

## STEP 1

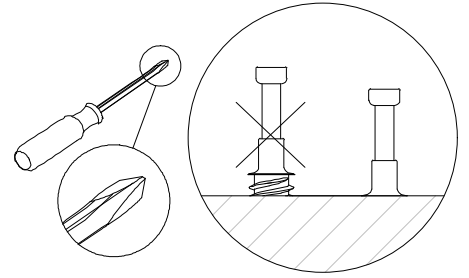
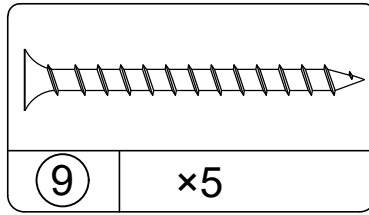
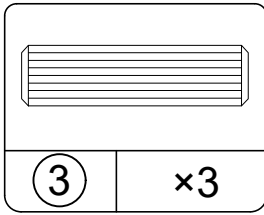
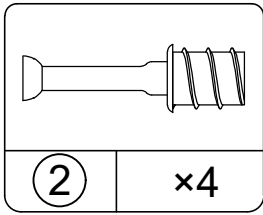

1.1 Screw (2) into (A) as illustrated.

1.2 Attach (G) & (I) to (A) with (3) & (9) as illustrated.

\* The door can be on the left side or right side, follow the instruction to attach the door to the desired location.

### OPTION 1: DOOR ON THE LEFT SIDE

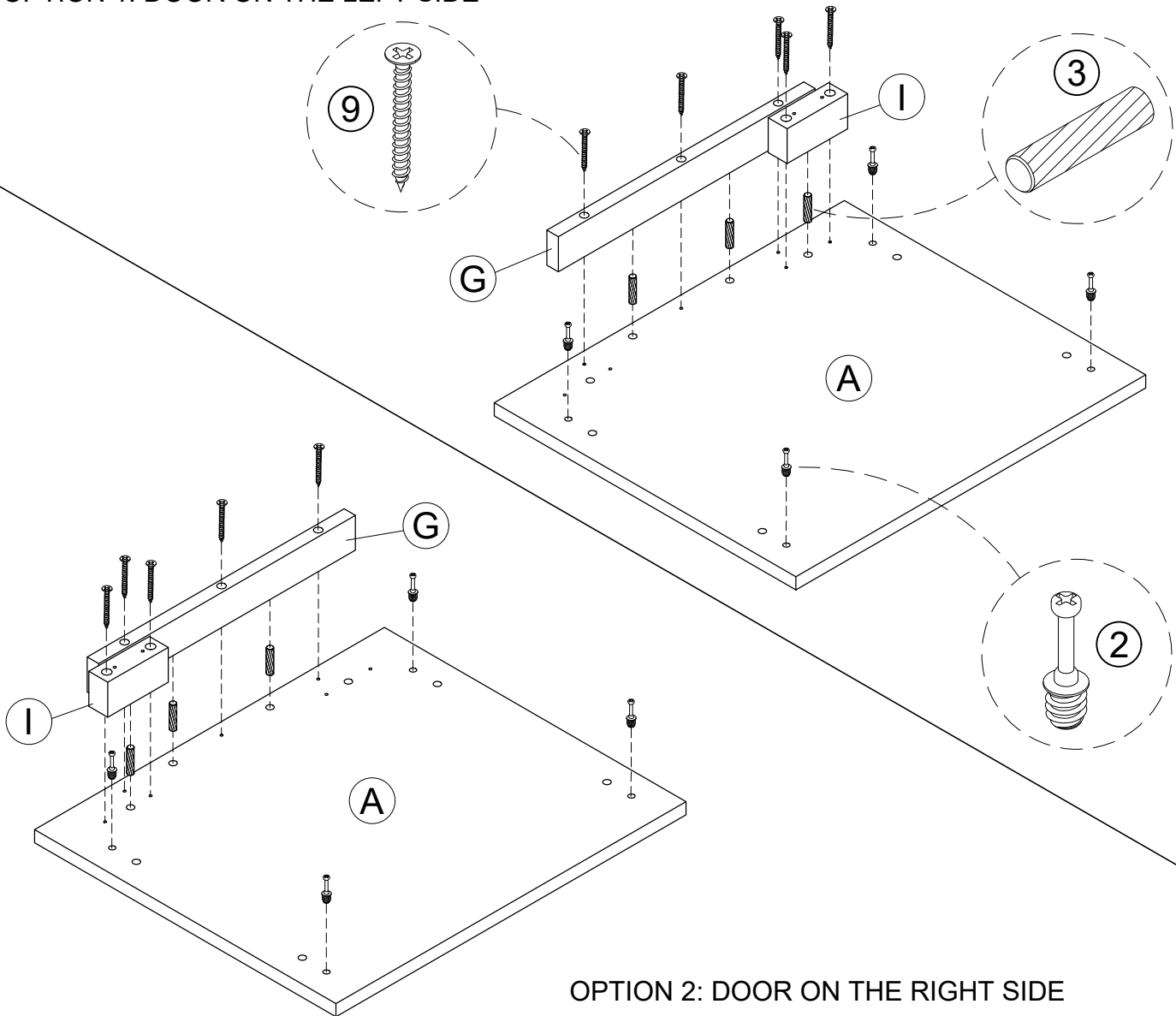

### OPTION 2: DOOR ON THE RIGHT SIDE

## STEP 2

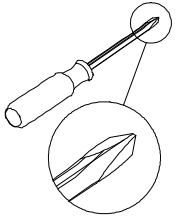
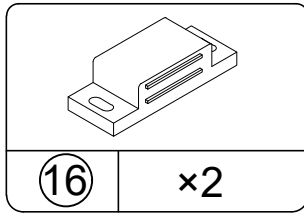
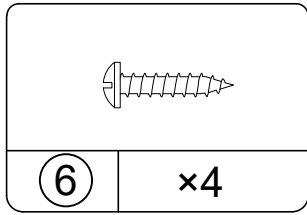
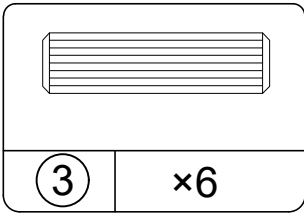

2.1 Insert (3) into (F) as illustrated.

2.2 Attach (16) to (F) & (I) with (6) as illustrated.

\* The door can be on the left side or right side, follow the instruction to attach the door to the desired location.

### OPTION 1: DOOR ON THE LEFT SIDE

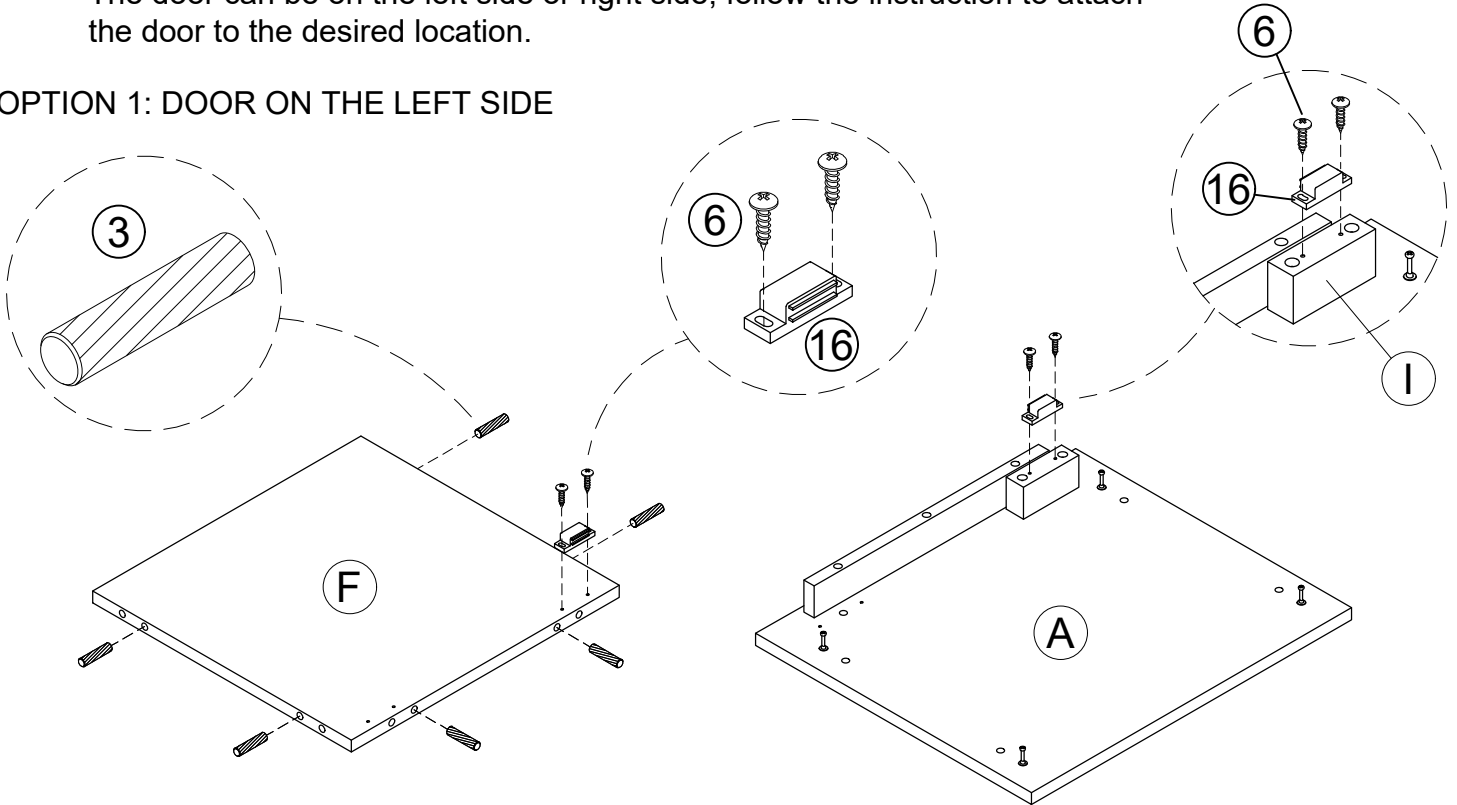

### OPTION 2: DOOR ON THE RIGHT SIDE

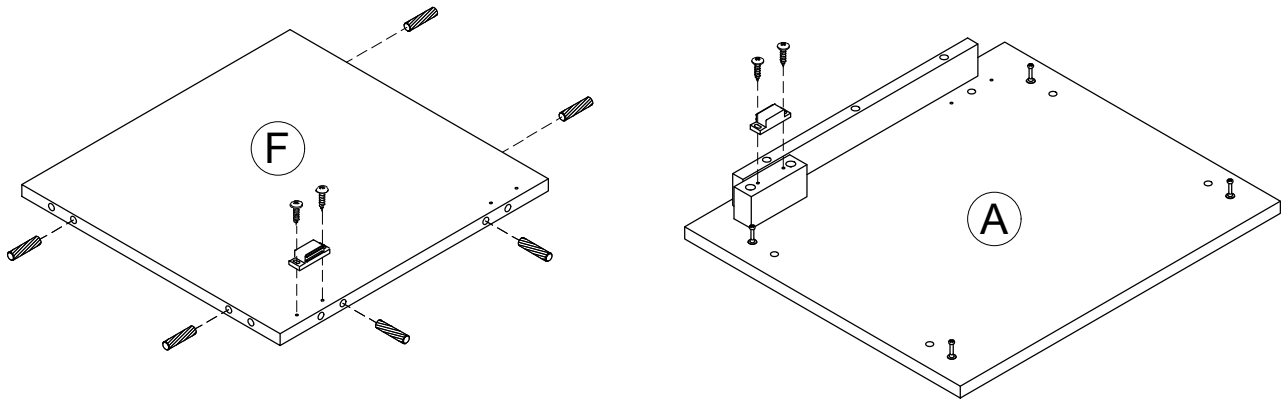



## STEP 3

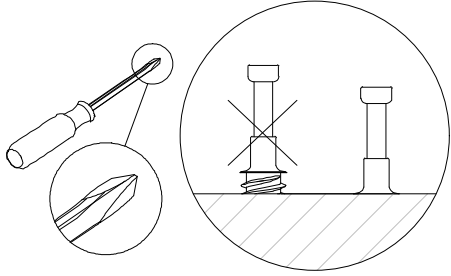
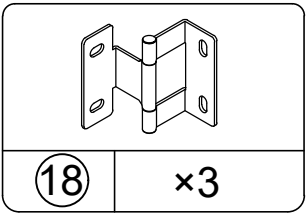
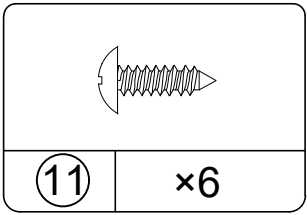
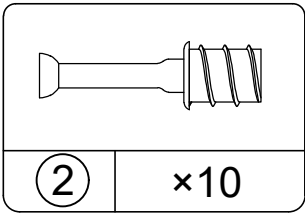

3.1 Screw (2) into (K) & (L) as illustrated.

3.2 Option 1 - door on the left side: Attach (18) to (K) with (11) as illustrated.

3.2 Option 2 - door on the right side: Attach (18) to (L) with (11) as illustrated.

### OPTION 1: DOOR ON THE LEFT SIDE

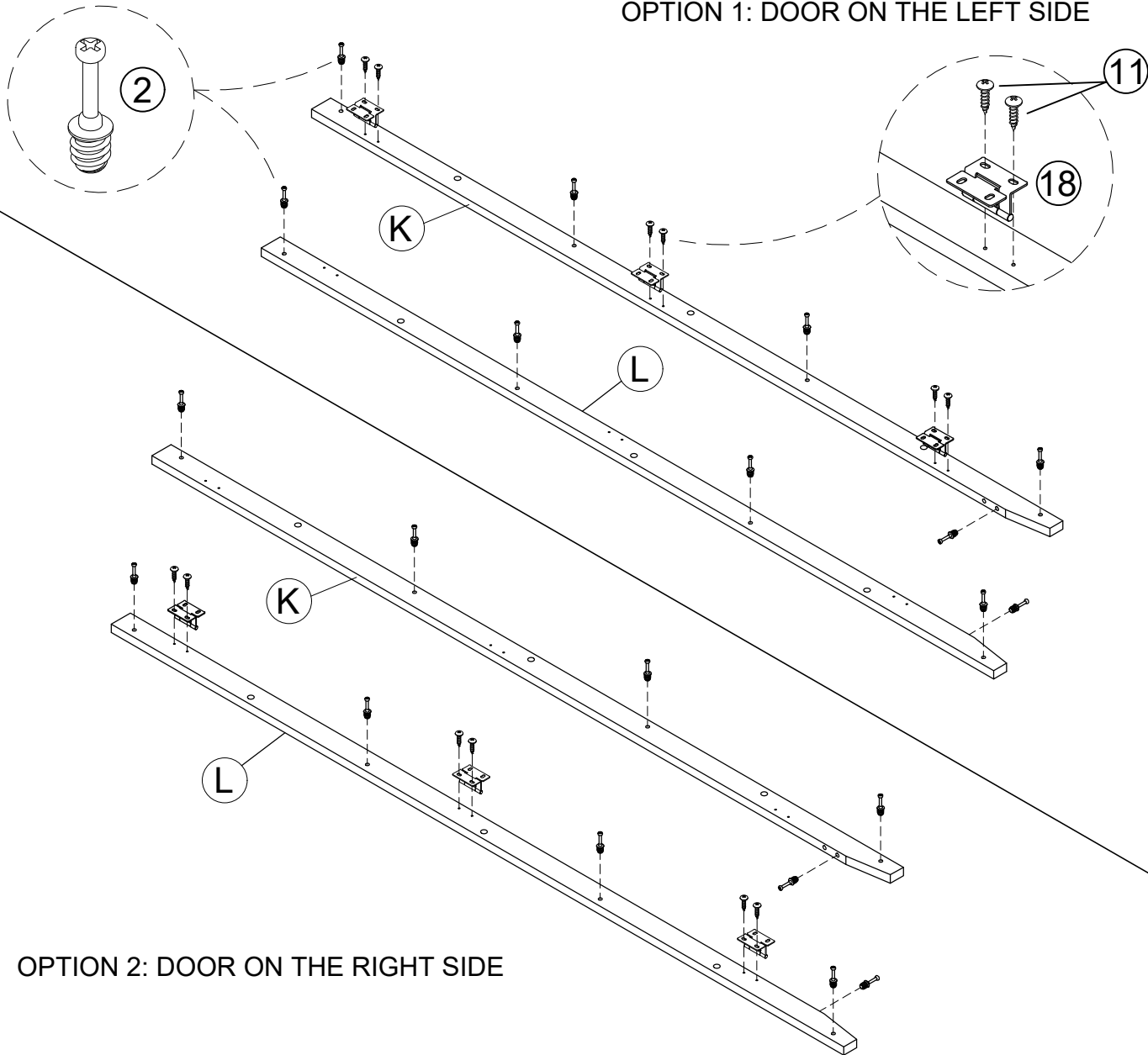

### OPTION 2: DOOR ON THE RIGHT SIDE

## STEP 4

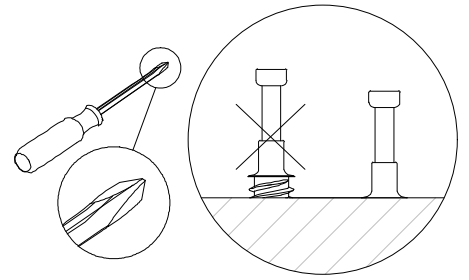
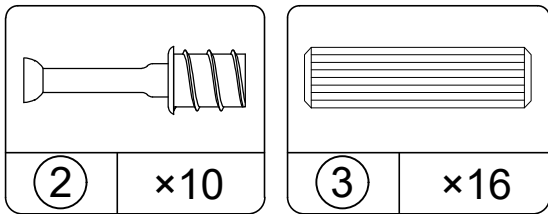

- 4.1 Screw (2) into (B), (C) & (H) as illustrated.
- 4.2 Insert (3) into (B), (C), (D) & (H) as illustrated.

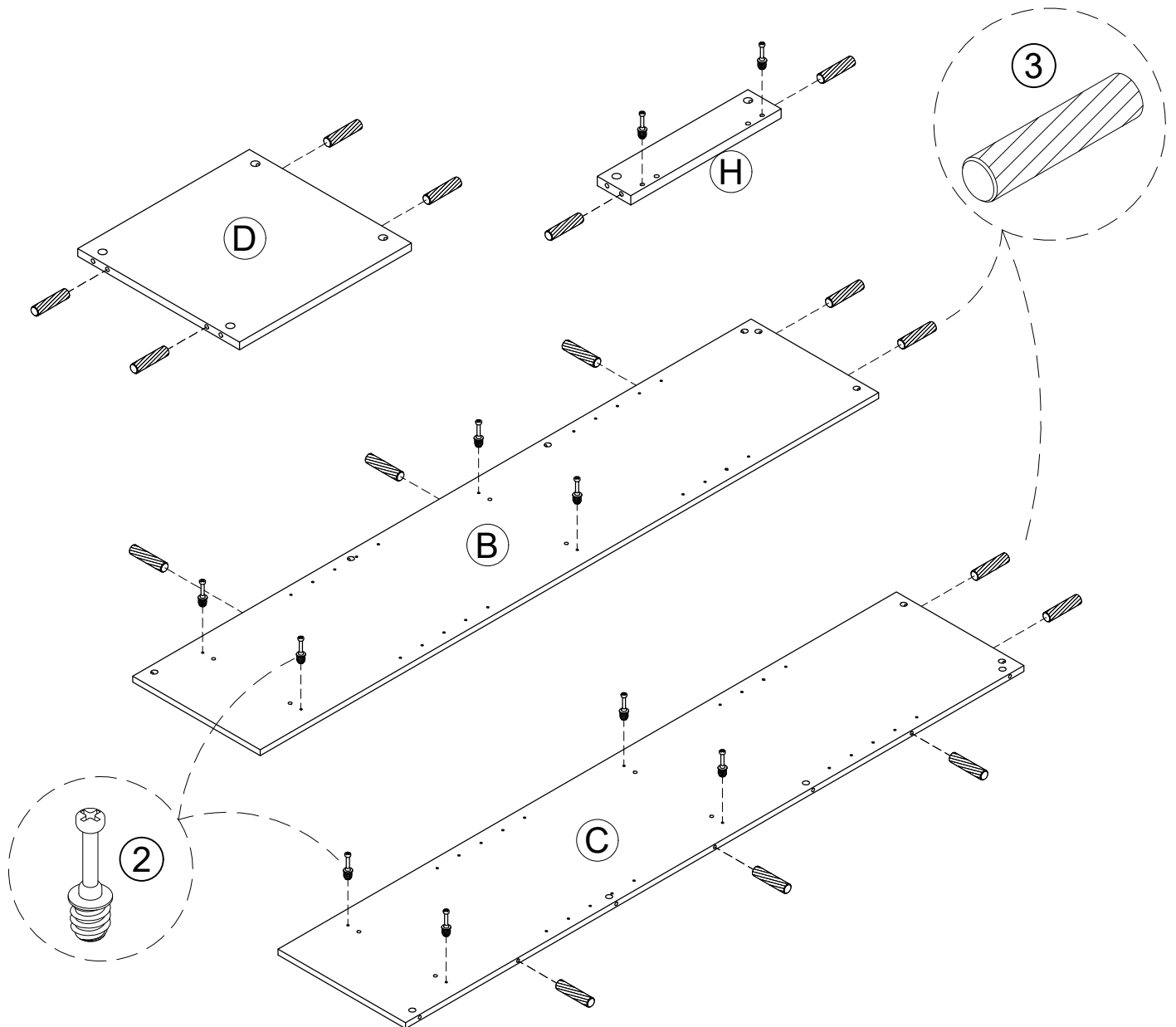

## STEP 5

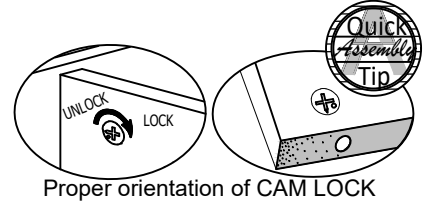
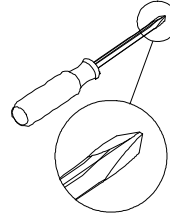
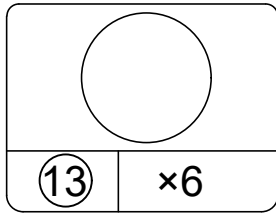
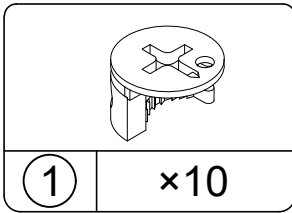

- 5.1 Attach (K) to (B) with (1) as illustrated.
- 5.2 Attach (L) to (C) with (1) as illustrated.
- 5.3 Attach (H) to (F) with (1) as illustrated.
- 5.4 Cover cam lock hole with (13) as illustrated.

OPTION 1:  
HINGE SHOWN IF  
THE DOOR IS ON  
THE LEFT SIDE

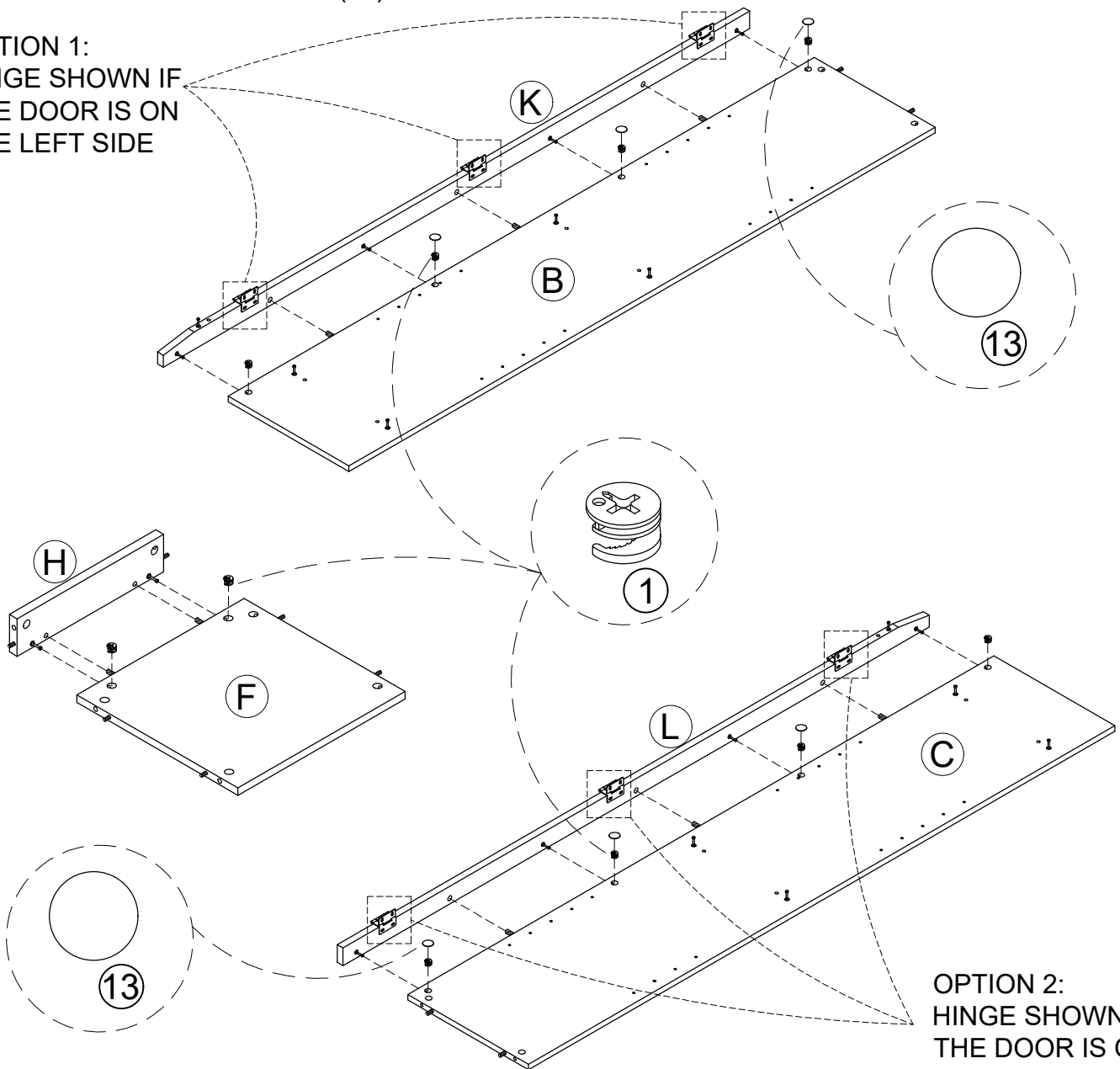

OPTION 2:  
HINGE SHOWN IF  
THE DOOR IS ON  
THE RIGHT SIDE

## STEP 6

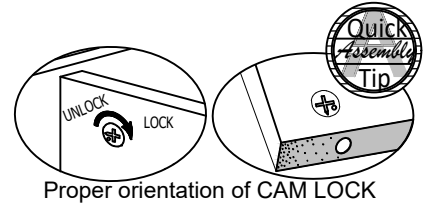
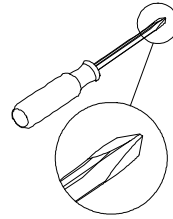
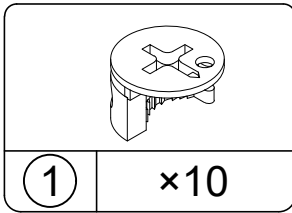

6.1 Attach (D), (F) & (H) to (B) & (C) with (1) as illustrated.

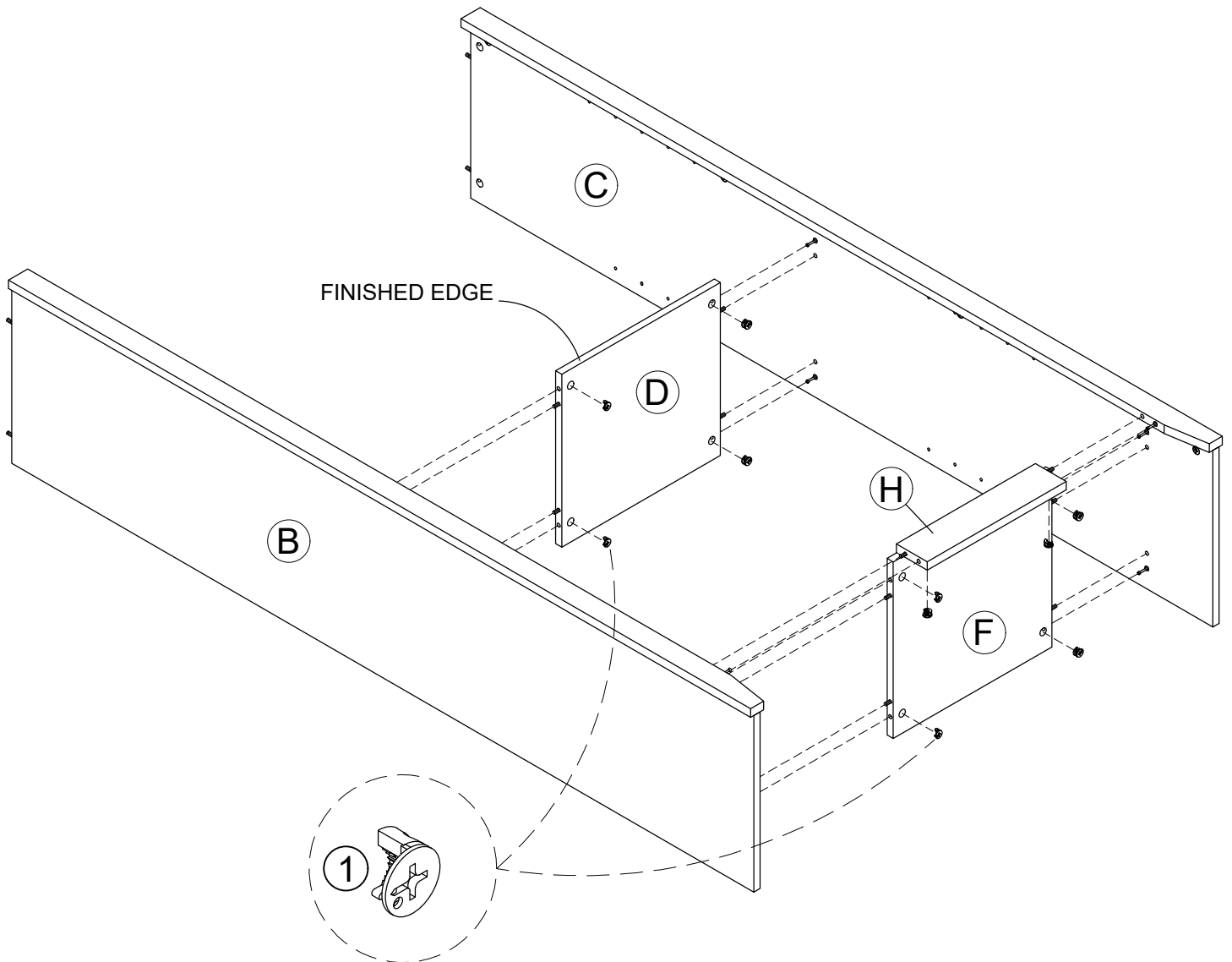

## STEP 7

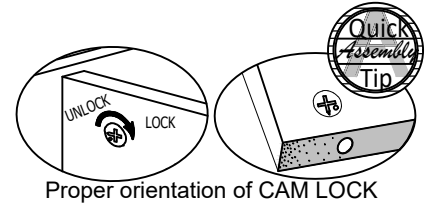
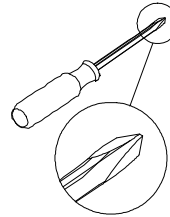
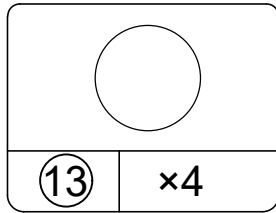
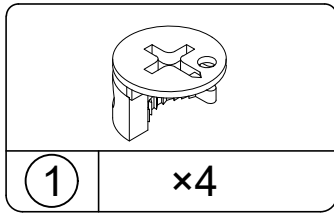

7.1 Attach (A) to sub-assembly B/C/D/F from previous step with (1) as illustrated.

7.2 Cover cam lock hole with (13) as illustrated.

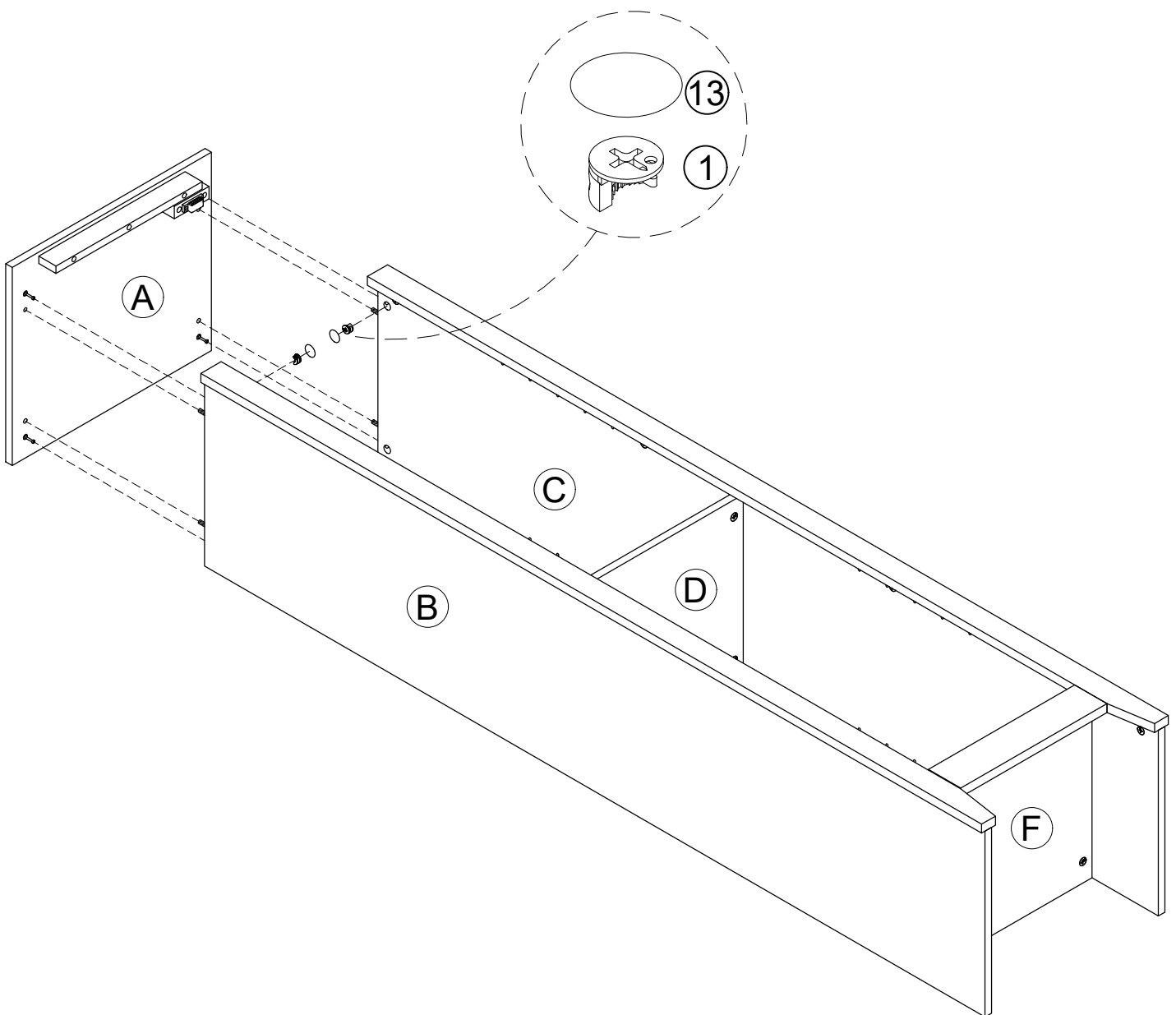

## STEP 8

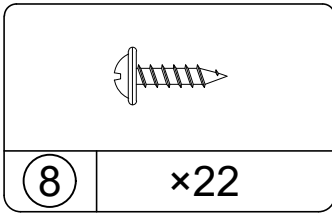

**IMPORTANT!** THE BACK PANEL IS A STRUCTURAL PART OF THIS UNIT AND MUST BE INSTALLED PROPERLY.

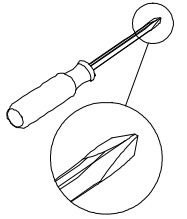

8.1 Attach (M) to sub-assembly A/B/C/F from previous step with (8) as illustrated. Important: Assure that the unit is square. Distance from corner to corner must be equal as shown.

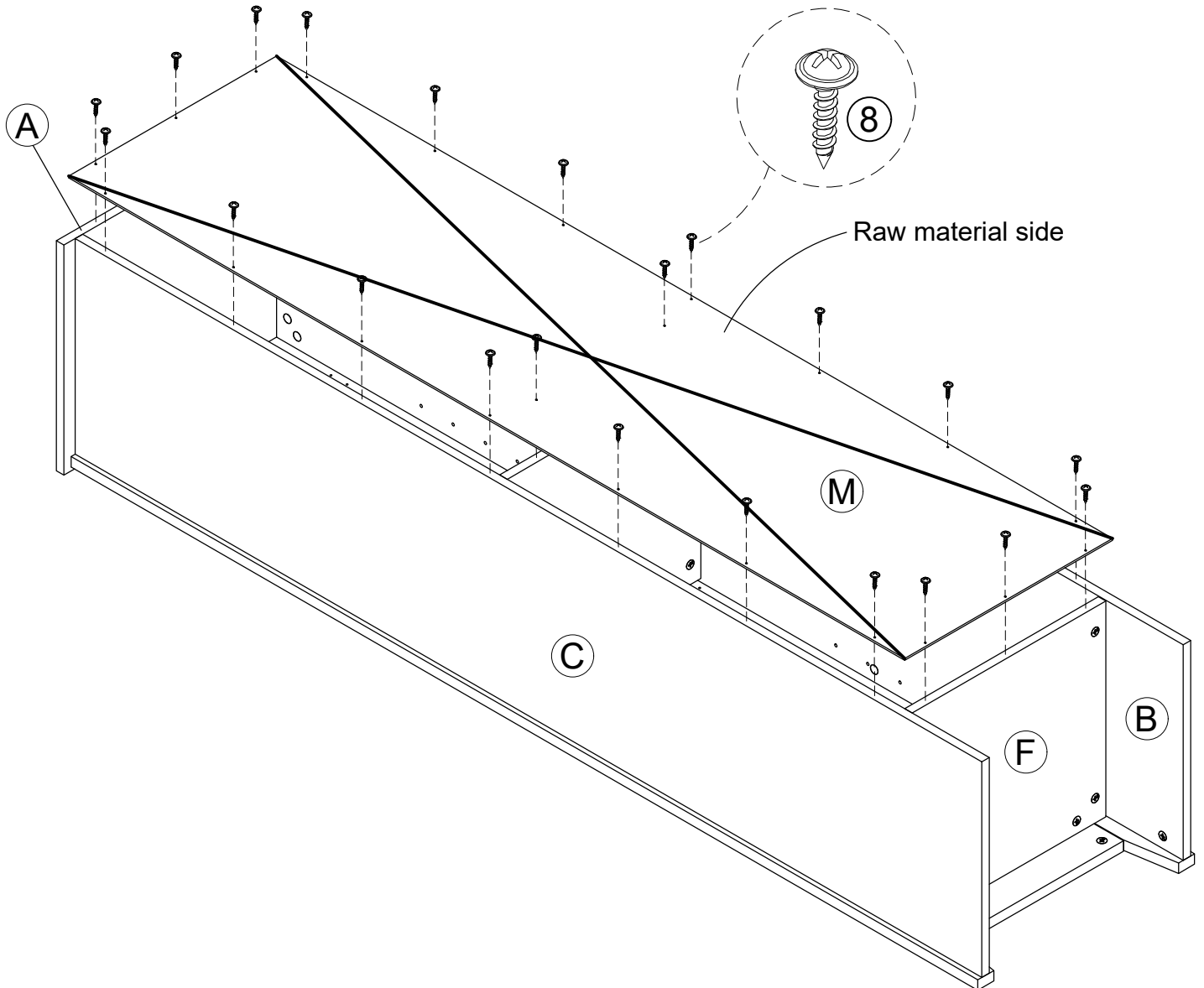

## STEP 9

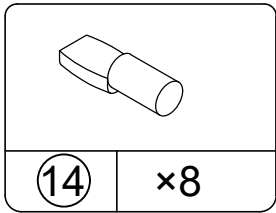

9.1 Insert the shelf supports (14) at the desired level and place the adjustable shelves (E) onto the shelf supports.

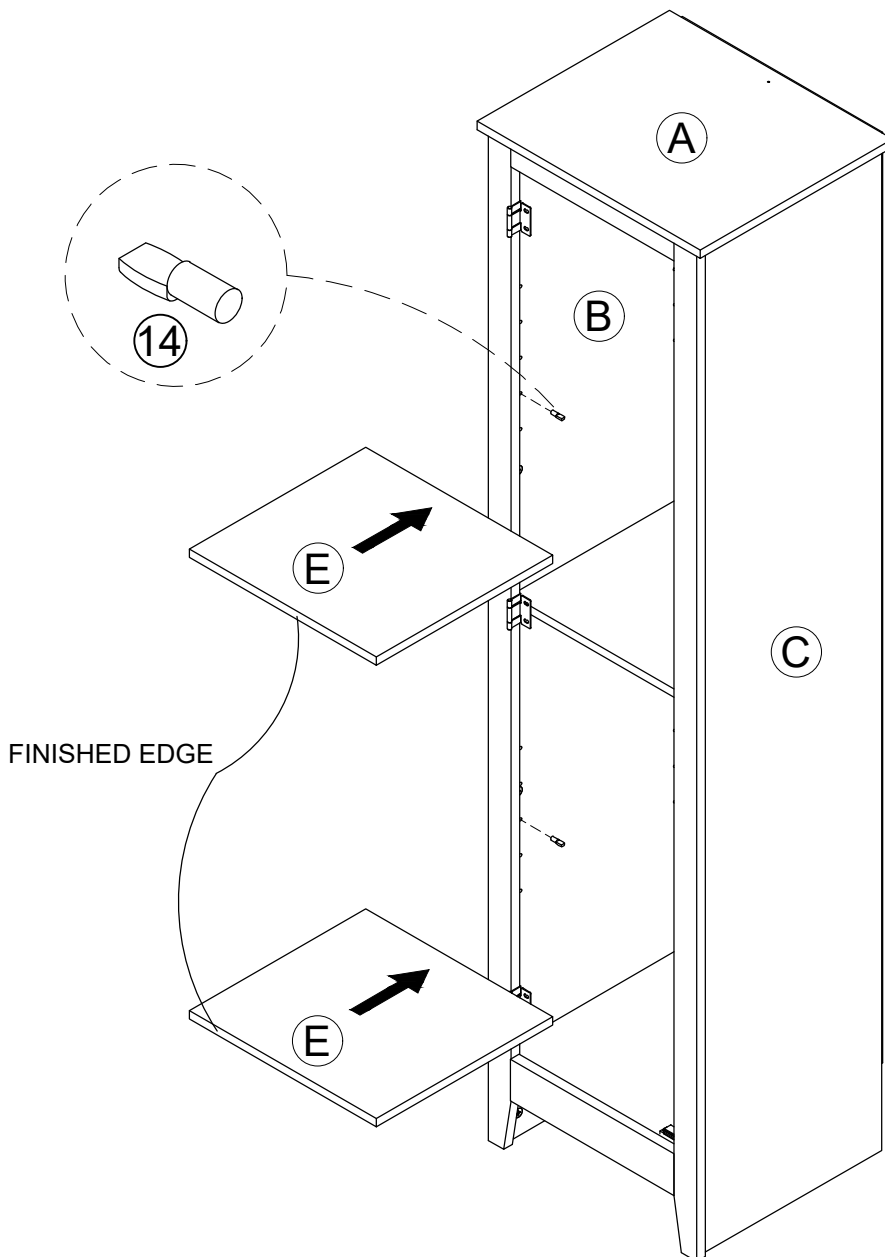

## STEP 10

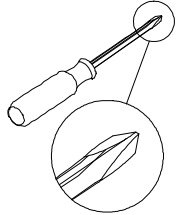
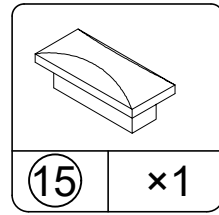
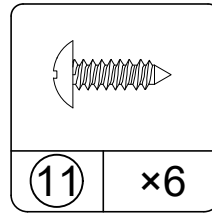
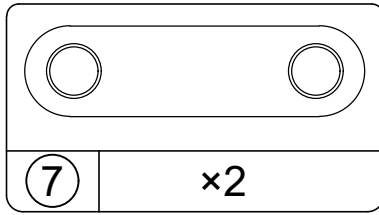
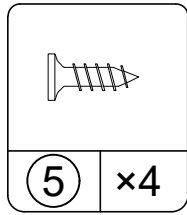
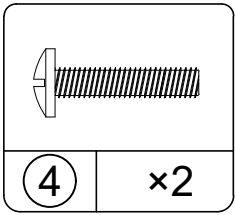

10.1 Attach (J) to sub-assembly A/B/C/F from previous step with (11) as illustrated.

10.2 Attach (7) to (J) with (5) as illustrated.

10.3 Attach (15) to (J) with (4) as illustrated.

OPTION 1:  
DOOR ON THE LEFT SIDE

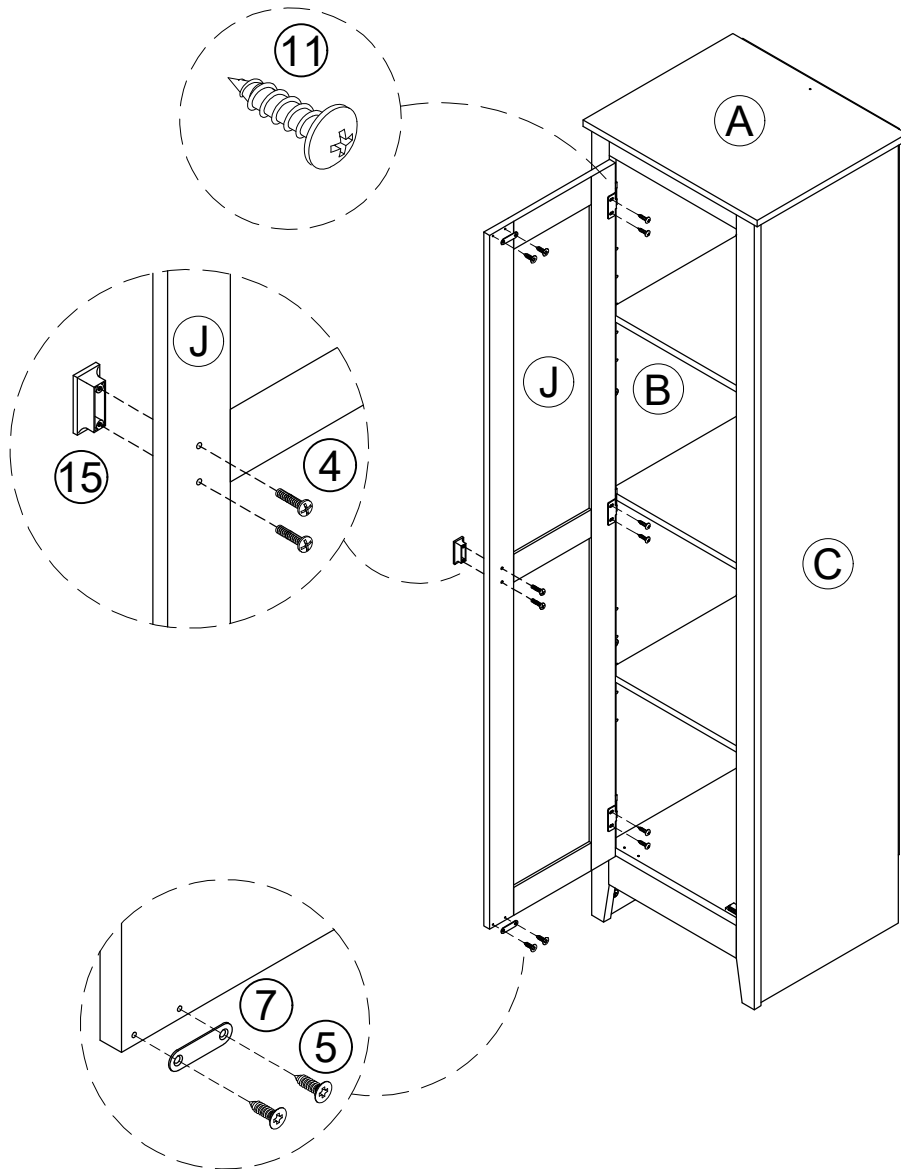

OPTION 2:  
DOOR ON THE RIGHT SIDE

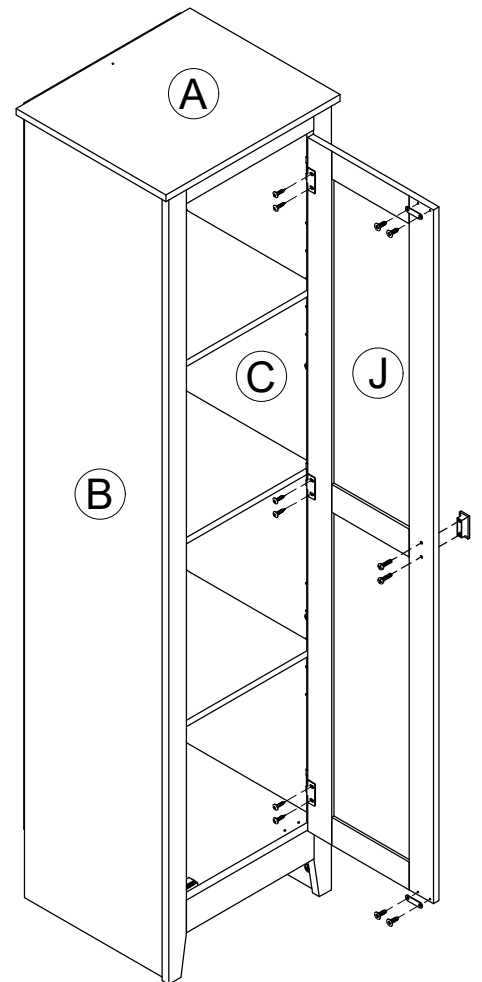



## STEP 11

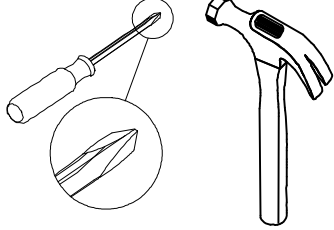
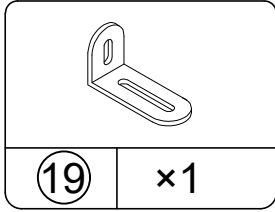
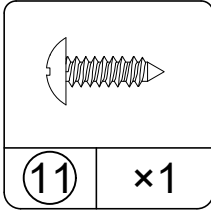
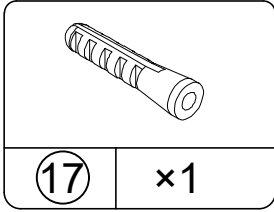
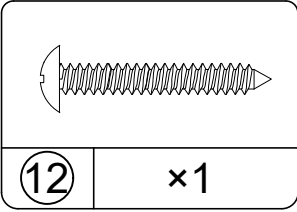

**IMPORTANT:** THIS UNIT MUST BE SECURE TO THE WALL TO HELP PREVENT TIPOVER. FOLLOW THESE INSTRUCTIONS TO INSTALL THE ANTI-TIPPING SAFETY BRACKET PROVIDED WITH THIS PRODUCT.

- 11.1 Drill a 3/16" (5mm) diameter hole in the wall. Tap the wall anchor (17) into the hole until it is flush.
- 11.2 Fasten wall bracket (19) to wall anchor (17) with screw (12). Make sure screw (11) is fully tightened.

**For Masonry, Concrete, or other wall materials:**  
Consult your local hardware store for appropriate anchors to securely attach the safety bracket

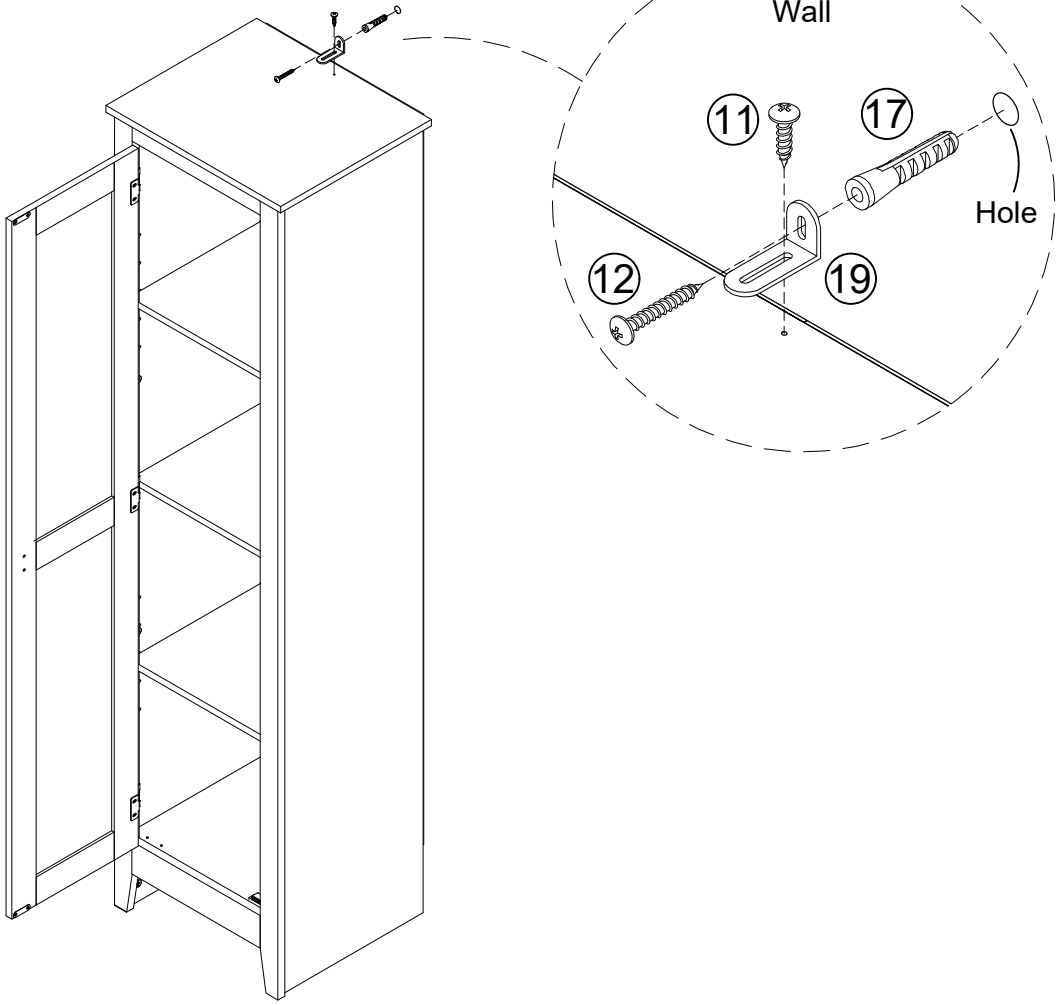

# STEP 12

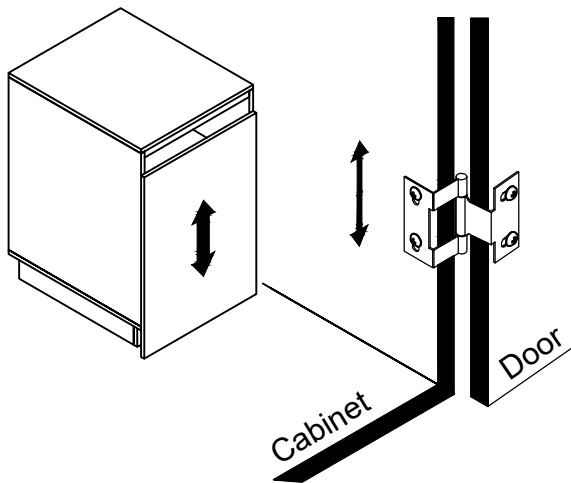
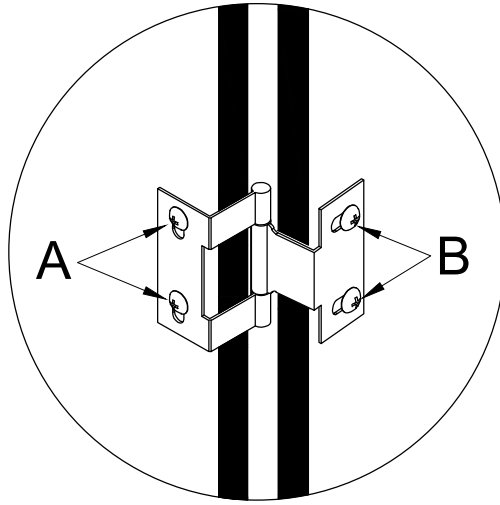

**To adjust the vertical height:**

Loosen screw "A" and adjust door.

Tighten screw "A".

**Para ajustar la altura vertical.**

Afloje el tornillo "A" y ajuste la puerta.

Apriete el tornillo "A".

**Pour régler la hauteur verticale.**

Desserrez la vis "A" et ajustez la porte.

Serrer la vis "A".

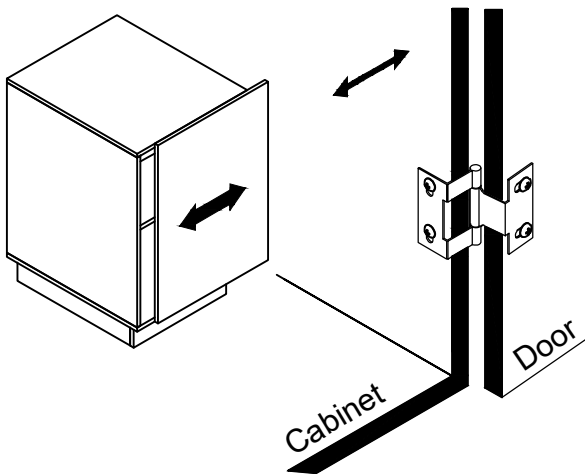

**To adjust side ways.**

Loosen screw "B" and adjust door.

Tighten screw "B".

**Para ajustar las vías laterales.**

Afloje el tornillo "B" y ajuste la puerta.

Apriete el tornillo "B".

**Pour ajuster les voies latérales.**

Desserrez la vis "B" et ajustez la porte.

Serrer la vis "B".

## Maximum Loads

This unit has been designed to support the maximum loads shown. Exceeding these load limits could cause sagging, instability, product collapse, and/or serious injury.

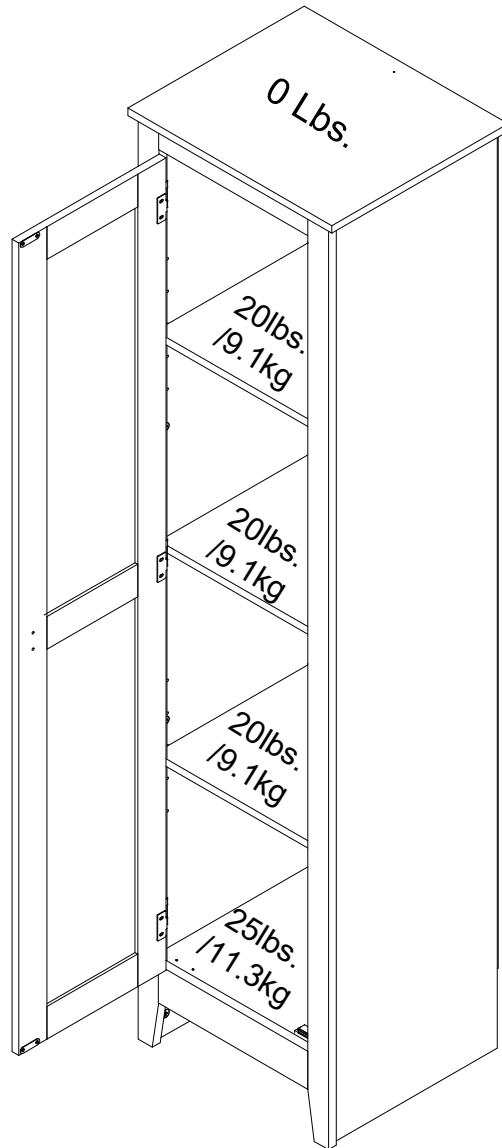

**Warning: Risk of injury to persons - do not place a television on this furniture. This furniture is not approved for use with a television.**

### Certificate of Conformity

1. This certificate applies to the Dorel Home Furnishings, Inc. product identified by this instruction manual.
2. This certificate applies to compliance of this product with the CPSC Ban on Lead-Containing Paint (16 CFR 1303).
3. This product is distributed by: Dorel Home Furnishings, Inc.  
410 East First Street South  
Wright City, MO 63390  
636-745-3351
4. Site of Manufacture: Binh Duong, Viet Nam.
5. See front page of instruction manual for date of manufacture.

## Register your product to receive the following:



- \* New trend details - sneak peek on what's new
- \* Surveys - have a voice within our community
- \* Exclusive deals and discount codes
- \* Quick and easy replacement part service

To register your product, visit [ameriwoodhome.com](http://ameriwoodhome.com)

## *5 Star Rating*



Visit your local retailer's website, rate your purchased product and leave us some feedback!

We would like to extend a big "Thank You" to all of our customers for taking the time to assemble this Ameriwood Home product, and to give us your valuable feedback.

*Thank You!*

## Cubierta Delantera

Este libro de instrucciones contiene información **IMPORTANTE** de seguridad. Por favor lea y manténgalo para referencia en el futuro.

**No Regrese este producto!** Comuníquese con nuestro amistoso equipo de servicio al cliente para obtener ayuda.

Llámenos al: 1-800-489-3351 (Gratis) Lunes - Viernes 9am - 5pm CST

**Visitar:** [www.ameriwoodhome.com](http://www.ameriwoodhome.com)

## PRECAUCION

Este mueble puede volcarse y causar graves heridas y/o muerte.

Anclar el mueble a un poste de madera en la pared (si esto se requiere).

No Permita que los niños monten el mueble.

Mantenga los artículos más pesados en los cajones de abajo.

## Consejos Útiles (página 2)

- Abra su artículo en el área donde usted planea utilizarlo para evitar levantar y moverlo menos
- Identificar, ordenar y contar las piezas antes de intentar ensamblar
- Las clavijas de compresión se golpean con un martillo
- Las diapositivas están marcadas con una R (derecha) y L (izquierda) para la colocación correcta
- Asegúrese de que siempre este el punto localizado en la parte superior de bloqueador de leva este volteado hacia borde exterior
- Utilizar todos los clavos para el panel de atrás y distribuirlos por igual
- El panel de atrás debe utilizarse para asegurarse de que la unidad quede fija y firme
- No use químicas fuertes ni limpiadores abrasivos en este artículo
- Nunca empuje, tire ni arrastre los muebles

## Antes de Que Empieces (página 3)

- Lea cuidadosamente cada paso y siga el orden correcto

- Separar y contar todas sus piezas y hardware

- Dése suficiente espacio para el proceso de ensamble

- Tenga las siguientes herramientas: destornillador de cabeza plana, #2 cabeza Phillips

Destornillador y martillo

- Precaución: Si usa un taladro electrónico o un destornillador eléctrico para atornillar, por favor asegúrese que deje de atornillar cuando el tornillo este apretado. Fallar hacer esto puede causar barrer el tornillo.

## Sistema de fijar el bloqueo de leva (página 3)

Esta sistema de fijar el bloqueo de leva sera usado en todo el proceso ensamble.

## Identificación de los Paneles (Página 4-5)

Este no es el tamaño real

- (A) ARRIBA
- (B) PANEL LATERAL IZQUIERDO
- (C) PANEL LATERAL DERECHO
- (D) ESTANTE FIJO
- (E) ESTANTE AJUSTABLE
- (F) ABAJO
- (G) DELANTAL SUPERIOR
- (H) FALDA INFERIOR
- (I) BLOQUE DE MADERA
- (J) PUERTA
- (K) FALDA IZQUIERDA
- (L) FALDA DERECHA
- (M) PANEL TRASERO

## Lista de Piezas (Página 6)

Tamaño real

- (1) Bloqueo de leva
- (2) Perno de leva
- (3) Taco de madera
- (4) Perno
- (5) Tornillo
- (6) Tornillo
- (7) Placa de impacto
- (8) Tornillo
- (9) Tornillo
- (11) Tornillo
- (12) Tornillo
- (13) Portada

Este no es el tamaño real

- (14) Soporte de estante
- (15) Mango
- (16) Cierre magnético
- (17) Anclaje de pared
- (18) Bisagra
- (19) Soporte de pared

## Página 7

1.1 Atornille (2) en (A) como se ilustra.

1.2 Fije (G) y (I) a (A) con (3) y (9) como se ilustra.

\* La puerta puede estar del lado izquierdo o del lado derecho, siga las instrucciones para colocar la puerta en la posición deseada.

## Página 8

2.1 Inserte (3) en (F) como se ilustra.

2.2 Fije (16) a (F) y (I) con (6) como se ilustra.

\* La puerta puede estar del lado izquierdo o del lado derecho, siga las instrucciones para colocar la puerta en la posición deseada.

## Página 9

3.1 Atornille (2) en (K) y (L) como se ilustra.

3.2 Opción 1 - puerta del lado izquierdo: Fije (18) a (K) con (11) como se ilustra.

3.2 Opción 2 - puerta del lado derecho: Fije (18) a (L) con (11) como se ilustra.

## Página 10

4.1 Atornille (2) en (B), (C) y (H) como se ilustra.

4.2 Inserte (3) en (B), (C), (D) y (H) como se ilustra.

## Página 11

5.1 Fije (K) a (B) con (1) como se ilustra.

5.2 Fije (L) a (C) con (1) como se ilustra.

5.3 Fije (H) a (F) con (1) como se ilustra.

5.4 Cubra el orificio de bloqueo de leva con (13) como se ilustra.

## Página 12

6.1 Fije (D), (F) y (H) a (B) y (C) con (1) como se ilustra.

## Página 13

7.1 Fije (A) al subensamblaje B/C/D/F del paso anterior con (1) como se ilustra.

7.2 Cubra el orificio de bloqueo de leva con (13) como se ilustra.

### **Página 14**

8.1 Fije (M) al subensamblaje A/B/C/F del paso anterior con (8) como se ilustra.

Importante: asegúrese de que la unidad sea cuadrada. La distancia de esquina a esquina debe ser igual a la que se muestra.

### **Página 15**

9.1 Inserte los soportes de los estantes (14) al nivel deseado y coloque los estantes ajustables (E) sobre los soportes de los estantes.

### **Página 16**

10.1 Fije (J) al subensamblaje A/B/C/F del paso anterior con (11) como se ilustra.

10.2 Fije (7) a (J) con (5) como se ilustra.

10.3 Fije (15) a (J) con (4) como se ilustra.

### **Página 17**

**IMPORTANTE: ESTA UNIDAD DEBE ESTAR FIJADA A LA PARED PARA AYUDAR A EVITAR VUELCOS. SIGA ESTAS INSTRUCCIONES PARA INSTALAR EL SOPORTE DE SEGURIDAD ANTIVUELCO SUMINISTRADO CON ESTE PRODUCTO.**

11.1 Taladre un orificio de 3/16" (5 mm) de diámetro en la pared. Golpee suavemente el anclaje de pared (17) en el orificio hasta que quede al ras.

11.2 Fije el soporte de pared (19) al anclaje de pared (17) con el tornillo (12). Asegúrese de que el tornillo (11) esté completamente apretado.

Para mampostería, hormigón u otros materiales de pared: consulte en su ferretería local los anclajes apropiados para sujetar de forma segura el soporte de seguridad

### **Página 18**

Ajuste de bisagra

### **Página 19**

CARGA MAXIMA

Esta unidad ha sido diseñada para soportar la carga máxima anotada. El exceder estos límites puede causar inestabilidad, colapsarse y/o causar serias lesiones.

**ADVERTENCIA:** Riesgo de lesiones a las personas - no coloque un televisor sobre muebles. Este mueble no está aprobado para su uso con un televisor.

### **Página 20**

Registre su producto para recibir lo siguiente:

- \* Detalles de nuevas tendencias - Vistazo a lo nuevo
- \* Encuestas - aloc su voz entre su comunidad
- \* Códigos de ofertas y descuentos exclusivos
- \* Fácil y rápido servicio de partes de remplace

Para registrar su producto, visite [ameriwoodhome.com](http://ameriwoodhome.com) - Clasificación de 5 estrellas

Visite el sitio web de su distribuidor local, califique el producto que compró y déjenos sus comentarios.

Nos gustaría enviar un gran "Agradecimiento" a todos nuestros clientes por tomarse el tiempo de ensamblar este producto de Ameriwood Home, y por darnos sus valiosos comentarios.

Gracias

## Couverture Avant

CE LIVRET D'INSTRUCTION CONTIENT DES INFORMATIONS **IMPORTANTES** SUR LA SÉCURITÉ.  
VEUILLEZ LIRE ET GARDER POUR UNE RÉFÉRENCE FUTURE

**Ne retournez pas ce produit!** Contactez notre équipe de service à la clientèle amicale d'abord pour obtenir de l'aide.

**Appelez-nous:** 1-800-489-3351 (sans frais) du Lundi au Vendredi de 9h à 17h Heure Centrale

**Visitez:** [www.ameriwoodhome.com](http://www.ameriwoodhome.com)

## ATTENTION

Le meuble peut basculer et causer des blessures graves ou la mort.

Ancrer le meuble à une planche murale dans le mur (si indiqué).

Ne laissez pas les enfants grimper sur le meuble.

Placez les articles lourds sur les étagères ou dans les tiroirs inférieurs.

## Astuces Utiles (page 2)

- Ouvrez votre article dans la zone que vous prévoyez de le garder pour moins de levage lourd
- Identifier, trier et compter les pièces avant d'essayer d'assembler
- Les goujons de compression sont taraudés avec un Marteau
- Les glissières sont marquées d'un R (droit) et d'un L (gauche) pour un bon placement
- Assurez-vous toujours de faire face la pointe situé sur le haut de la Serrure de Came vers le bord extérieur
- Utiliser tous les clous fournis pour le panneau arrière et les répartir également
- Le panneau arrière doit être utilisé pour vous assurer que votre appareil est robuste
- N'utilisez pas de produits chimiques agressifs ou de nettoyeurs abrasifs sur cet appareil
- Ne jamais pousser, tirer, ou faire glisser votre meuble

## Avant de Commencer (page 3)

- Lisez attentivement chaque étape et suivez le bon ordre
- Séparez et comptez toutes vos pièces et matériaux
- Donnez-vous suffisamment de place pour l'assemblage
- Avoir les outils suivants: tournevis à tête plate, #2 tournevis Phillips, et Marteau
- Attention: Si vous utilisez une perceuse électrique ou un tournevis électrique pour visser, veuillez à ralentir et arrêter lorsque la vis est bien serrée. Le non-respect de cette consigne peut endommager la vis.

## Système de Fixation de Came (page 3)

Ce Système de Fixation de Came sera utilisé tout au long de l'assemblage.



## Page 4-5: Identification du conseil

### Pas la taille réelle

- (A) HAUT
- (B) PANNEAU LATERAL GAUCHE
- (C) PANNEAU LATÉRAL DROIT
- (D) TABLETTE FIXE
- (E) TABLETTE RÉGLABLE
- (F) BAS
- (G) TABLIER SUPÉRIEUR
- (H) TABLIER INFÉRIEUR
- (I) BLOC DE BOIS
- (J) PORTE
- (K) TABLIER GAUCHE
- (L) TABLIER DROIT
- (M) PANNEAU ARRIÈRE

## Page 6 Liste des pièces

### Taille actuelle

- (1) Serrure à came
- (2) Boulon à came
- (3) Cheville en bois
- (4) Boulon
- (5) Vis
- (6) Vis
- (7) Gâche
- (8) Vis
- (9) Vis
- (11) Vis
- (12) Vis
- (13) Couverture

### Pas de taille réelle

- (14) Support d'étagère
- (15) Poignée
- (16) Loquet magnétique
- (17) Ancrage mural
- (18) Charnière
- (19) Support mural

## Page 7

1.1 Visser (2) dans (A) comme illustré.

1.2 Fixez (G) et (I) à (A) avec (3) et (9) comme illustré.

- \* La porte peut être du côté gauche ou du côté droit, suivez les instructions pour fixer la porte à la position souhaitée.

## Page 8

2.1 Insérez (3) dans (F) comme illustré.

2.2 Fixez (16) à (F) et (I) avec (6) comme illustré.

- \* La porte peut être du côté gauche ou du côté droit, suivez les instructions pour fixer la porte à la position souhaitée.

## Page 9

3.1 Visser (2) dans (K) et (L) comme illustré.

3.2 Option 1 - porte du côté gauche : Fixez (18) à (K) avec (11) tel qu'illustré.

3.2 Option 2 - porte du côté droit : Fixez (18) à (L) avec (11) tel qu'illustré.

## Page 10

4.1 Visser (2) dans (B), (C) et (H) comme illustré.

4.2 Insérez (3) dans (B), (C), (D) et (H) comme illustré.

## Page 11

5.1 Fixez (K) à (B) avec (1) comme illustré.

5.2 Fixez (L) à (C) avec (1) comme illustré.

5.3 Fixez (H) à (F) avec (1) comme illustré.

5.4 Couvrir le trou de verrouillage à came avec (13) comme illustré.

## Page 12

6.1 Fixez (D), (F) et (H) à (B) et (C) avec (1) comme illustré.

## Page 13

7.1 Fixez (A) au sous-ensemble B/C/D/F de l'étape précédente avec (1) tel qu'illustré.

7.2 Couvrir le trou de verrouillage à came avec (13) comme illustré.

## Page 14

8.1 Fixez (M) au sous-ensemble A/B/C/F de l'étape précédente avec (8) tel qu'illustré.

Importante : Assurez-vous que l'unité est d'équerre. La distance d'un coin à l'autre doit être égale, comme indiqué.

## Page 15

9.1 Insérez les supports de tablette (14) au niveau désiré et placez les tablettes réglables (E) sur les supports de tablette.

## Page 16

10.1 Fixez (J) au sous-ensemble A/B/C/F de l'étape précédente avec (11) comme illustré.

10.2 Fixez (7) à (J) avec (5) comme illustré.

10.3 Fixez (15) à (J) avec (4) comme illustré.

## Page 17

**IMPORTANT : CET APPAREIL DOIT ÊTRE FIXÉ AU MUR POUR ÉVITER LE BASCULEMENT. SUIVEZ CES INSTRUCTIONS POUR INSTALLER LE SUPPORT DE SÉCURITÉ ANTI-BASCULEMENT FOURNI AVEC CE PRODUIT.**

11.1 Percez un trou de 3/16" (5 mm) de diamètre dans le mur. Enfoncez l'ancrage mural (17) dans le trou jusqu'à ce qu'il affleure.

11.2 Fixez le support mural (19) à l'ancrage mural (17) avec la vis (12). Assurez-vous que la vis (11) est bien serrée.

Pour la maçonnerie, le béton ou d'autres matériaux muraux : consultez votre quincaillerie locale pour connaître les ancrages appropriés pour fixer solidement le support de sécurité

## Page 18

Réglage charnière

## Page 19

### CHARGES MAXIMALES

Ce meuble a été conçu pour supporter les charges maximales indiquées. En excédant ces limites de charge, le meuble pourrait devenir instable, s'effondrer, et/ou causer des blessures graves.

**AVERTISSEMENT :** Risque de blessure corporelle - ne pas placer une télévision sur ce meuble. Ce meuble n'est pas approuvé pour une utilisation avec une télévision.

## Page 20

Enregistrez votre produit pour recevoir les éléments suivantes:

- \* Détails sur les nouvelles tendances - un aperçu sur les nouveautés
- \* Sondages - avoir une voix au sein de notre communauté
- \* Offres exclusives et codes promo
- \* Service de pièces de rechange rapide et facile

Pour enregistrer votre produit, visitez [ameriwoodhome.com](http://ameriwoodhome.com)

5 Étoiles

Visitez le site Web de votre détaillant local, évaluez le produit que vous avez acheté et laissez-nous vos commentaires !

Nous tenons à offrir un grand "Merci" à tous nos clients pour avoir pris le temps d'assembler ce produit "Ameriwood Home", et de nous donner vos commentaires précieux.

Merci