

7533296COM

2 Door 1 Drawer Storage Cabinet

systembuild™
EVOLUTION

Date of Purchase ___/___/___
Lot Number:

B347533296COM04GO

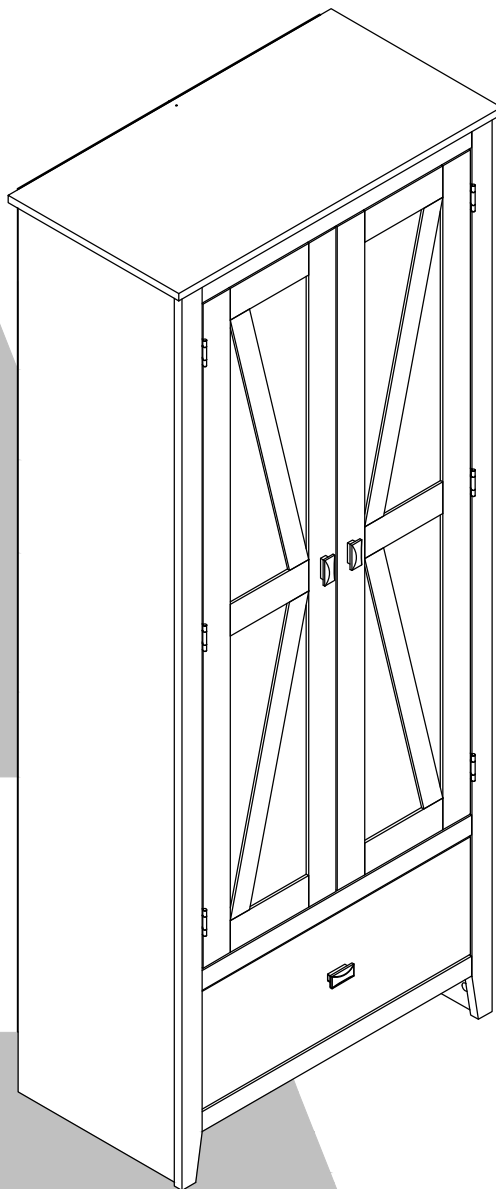

THIS INSTRUCTION BOOKLET CONTAINS **IMPORTANT** SAFETY INFORMATION. PLEASE READ AND KEEP FOR FUTURE REFERENCE.

Do Not Return This Product!

Contact our customer service team for help first.

Call: 1-800-489-3351 (toll free)

Monday-Friday 9am - 5pm CST

Visit: www.ameriwoodhome.com

WARNING

- Unit can tip over causing severe injury or death.
- Anchor unit to stud in wall (if instructed to).
- Do Not allow children to climb on unit.
- Put heavy items on lower shelves or drawers.

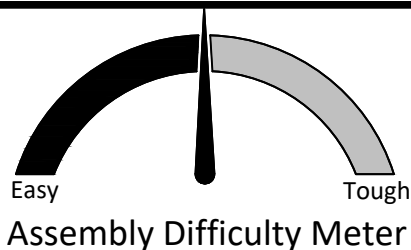

Follow Ameriwood Home



Do NOT return this product!

Contact our friendly customer service team first for help.

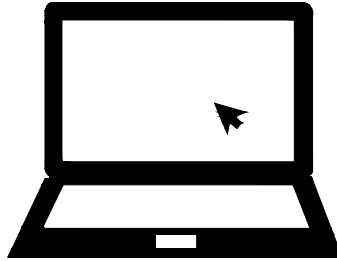

Visit ameriwoodhome.com

Assembly Tips



Helpful Hints

PEOPLE NEEDED FOR ASSEMBLY: 2

ESTIMATED ASSEMBLY TIME: 1 HOUR

- Open your item in the area you plan to keep it to avoid excessive heavy lifting.
- Identify, sort and count the parts before attempting assembly.
- Compression dowels are lightly tapped in with a hammer.
- Slides are labeled with a **R** (right) and **L** (left) for proper placement.
- Make sure to always face the point on the top of the Cam Lock towards the outer edge.
- Use all the nails provided for the back panel and spread them out equally.
- Back panel must be used to make sure your unit is sturdy.
- Do NOT use harsh chemicals or abrasive cleaners on this item.
- Never push, pull, or drag your furniture.

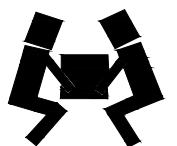
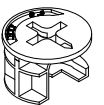

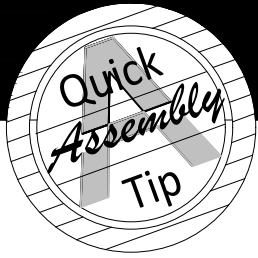

Before You Start

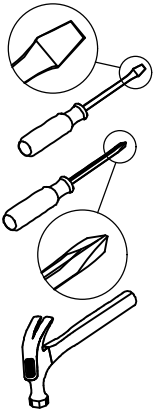

- ✓ Read through each step carefully and follow the proper order
- ✓ Separate and count all your parts and hardware
- ✓ Give yourself enough room for the assembly process
- ✓ Have the following tools: Flat Head Screwdriver, #2 Phillips Head Screwdriver and Hammer
- ✓ Caution: If using a power drill or power screwdriver for screwing, please be aware to slow down and stop when screw is tight. Failure to do so may result in stripping the screw.

Cam Lock Fastening System

This Cam Lock Fastening System will be used throughout the assembly process.

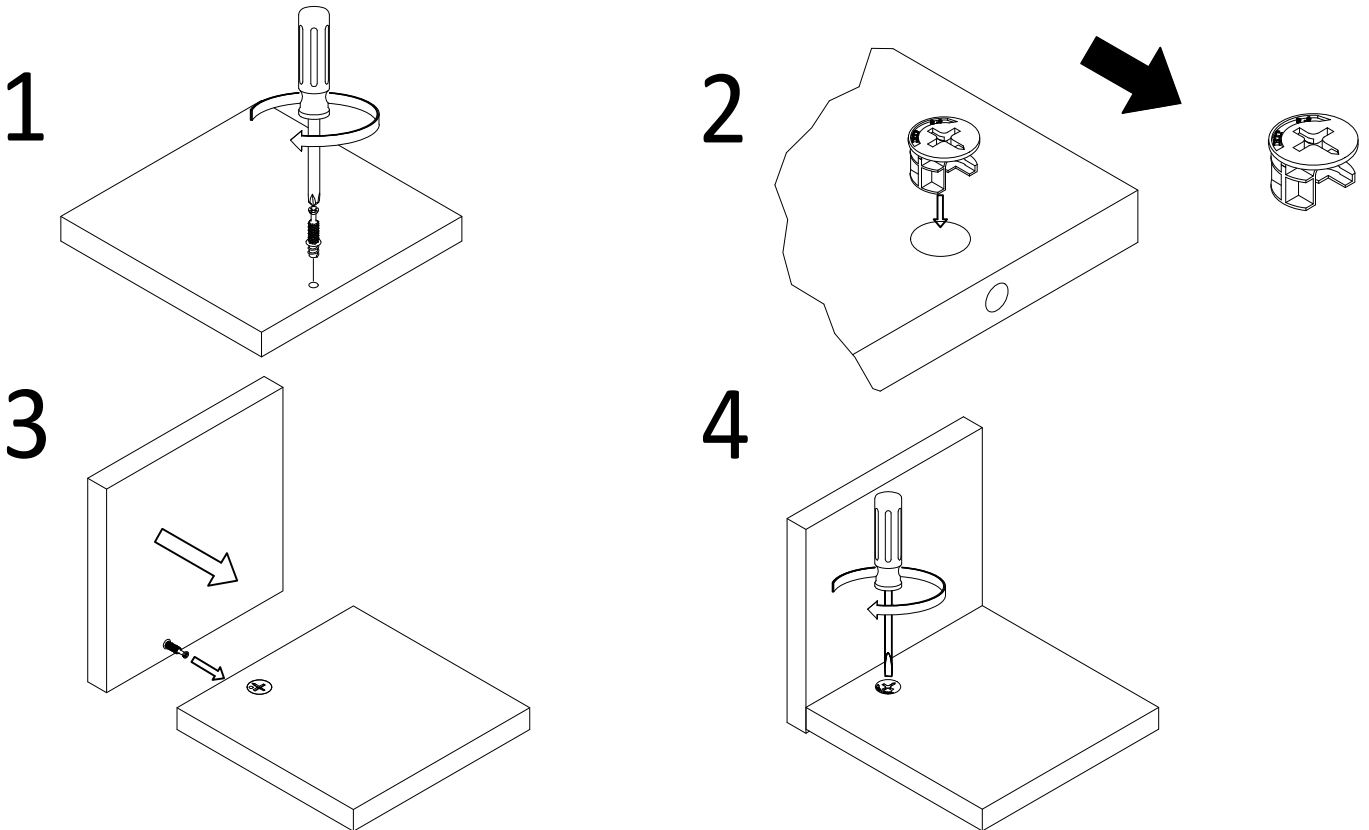

Board Identification

Not actual size

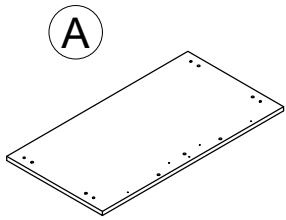

A
TOP
T7533296010GO
QTY: 1 PC

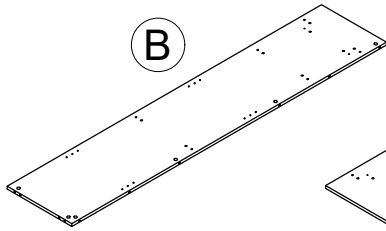

B
LEFT SIDE PANEL
T7533296020GO
QTY: 1 PC

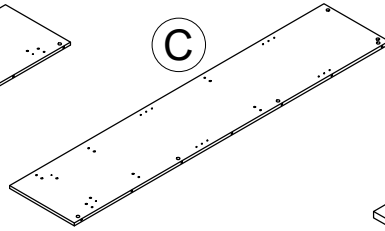

C
RIGHT SIDE PANEL
T7533296030GO
QTY: 1 PC

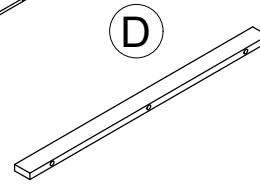

D
TOP APRON
T7533296040GO
QTY: 1 PC

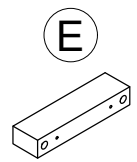

E
WOOD BLOCK
T7533296050GO
QTY: 1 PC

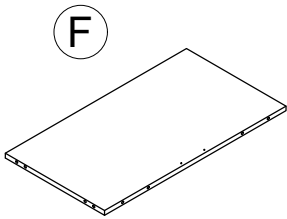

F
FIXED SHELF
T7533296060GO
QTY: 1 PC

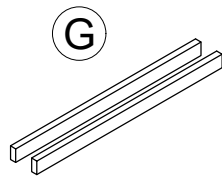

G
LOWER APRON
T7533296070GO
QTY: 2 PCS

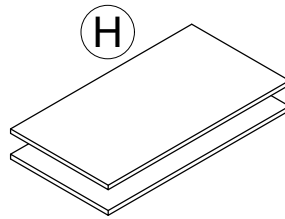

H
ADJUSTABLE SHELF
T7533296080GO
QTY: 2 PCS

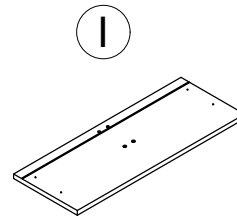

I
DRAWER FRONT
T7533296091GO
QTY: 1 PC

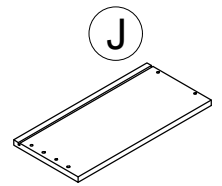

J
RIGHT DRAWER SIDE
T7533296102GO
QTY: 1 PC

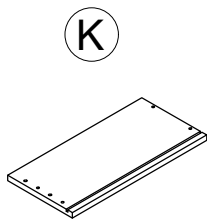

K
LEFT DRAWER
SIDE
T7533296112GO
QTY: 1 PC

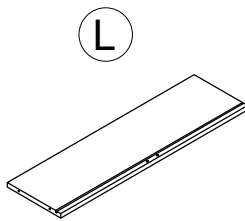

L
DRAWER BACK
T7533296121GO
QTY: 1 PC

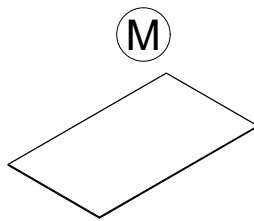

M
DRAWER BOTTOM
T7533296131GO
QTY: 1 PC

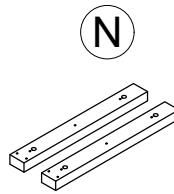

N
WOOD BLOCK
T7533296141GO
QTY: 2 PCS

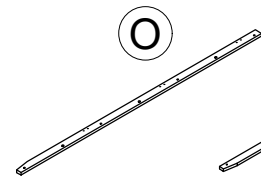

O
LEFT APRON
T7533296150GO
QTY: 1 PC

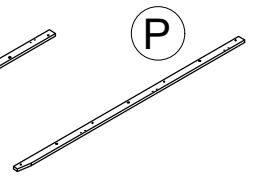

P
RIGHT APRON
T7533296160GO
QTY: 1 PC

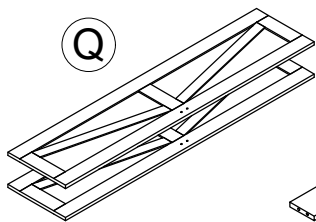

Q
DOOR
T7533296170GO
QTY: 2 PCS

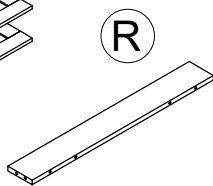

R
FRONT BOTTOM
PANEL
T7533296180GO
QTY: 1 PC

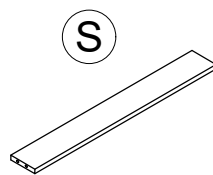

S
REAR BOTTOM
PANEL
T7533296190GO
QTY: 1 PC

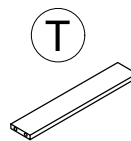

T
DRAWER
SUPPORT
T7533296200GO
QTY: 1 PC

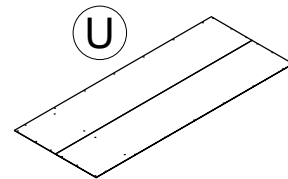

U
BACK PANEL
T7533296210GO
QTY: 1 PC

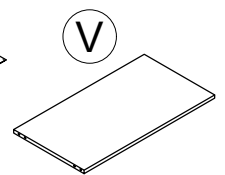

V
FIXED SHELF
T7533296220GO
QTY: 1 PC

Board Identification

Not actual size

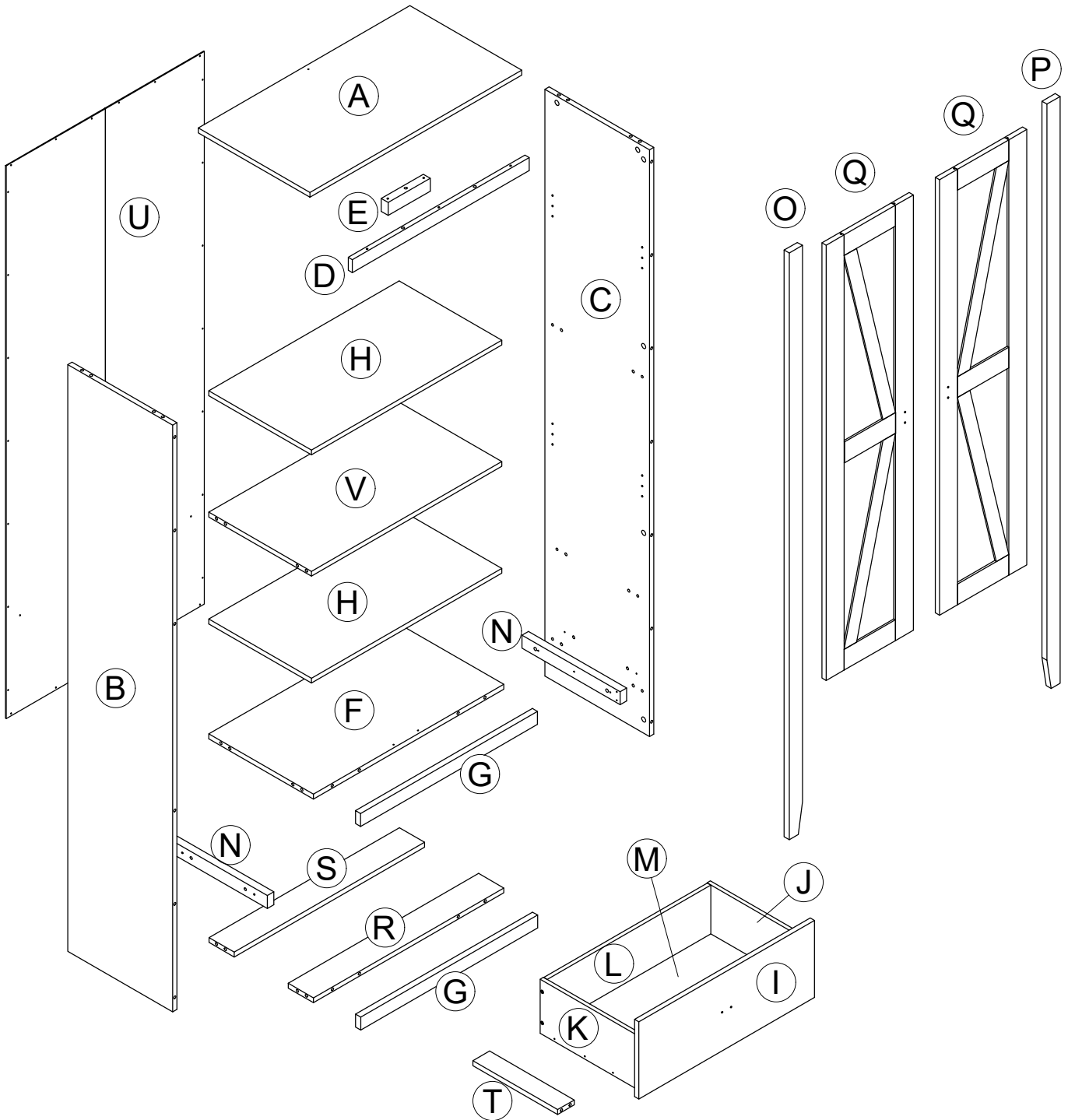

Part List

Actual Size

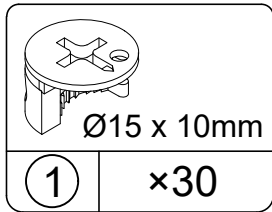

CAM LOCK
TGO2100

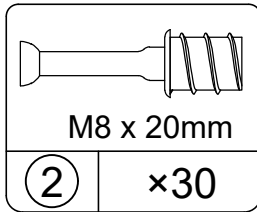

CAM BOLT
TGO2000

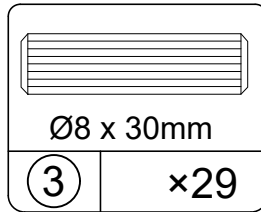

WOOD DOWEL
TGO2900

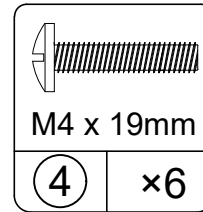

BOLT
TGO1608

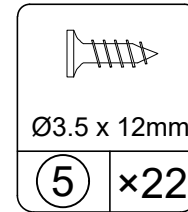

SCREW
TGO1007

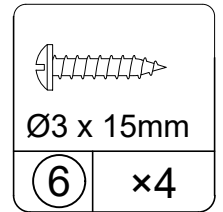

SCREW
TGO1315

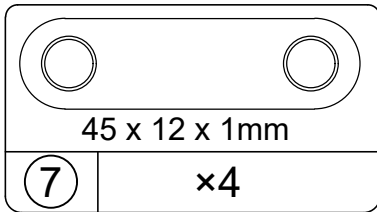

STRIKE PLATE
TGO3525

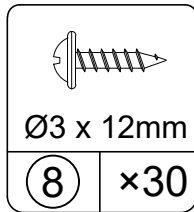

SCREW
TGO1301

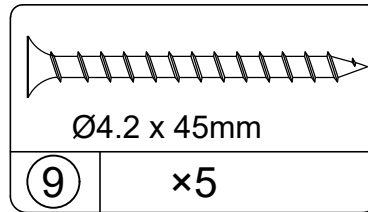

SCREW
TGO1008

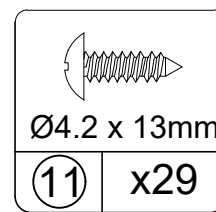

SCREW
TGO1304

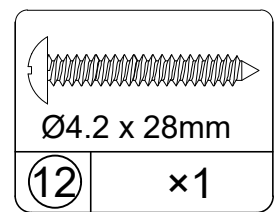

SCREW
TGO1314

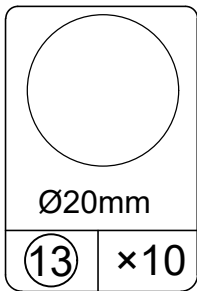

COVER
TGO2214

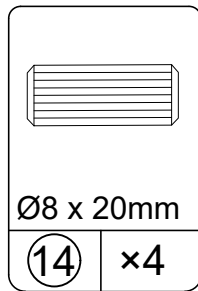

WOOD DOWEL
TGO2907

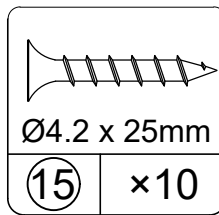

SCREW
TGO1001

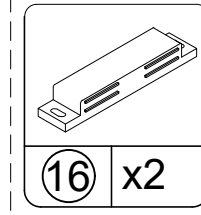

MAGNETIC
CATCH
TGO6511

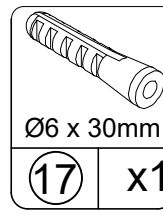

WALL
ANCHOR
TGO6501

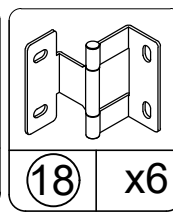

HINGE
TGO4306

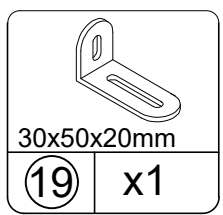

WALL
BRACKET
TGO3502

No Actual Size

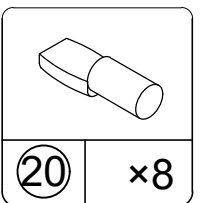

SHELF
SUPPORT
TGO2800

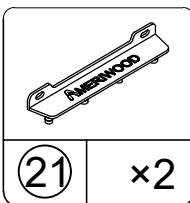

DRAWER
BRACKET
TGO6513

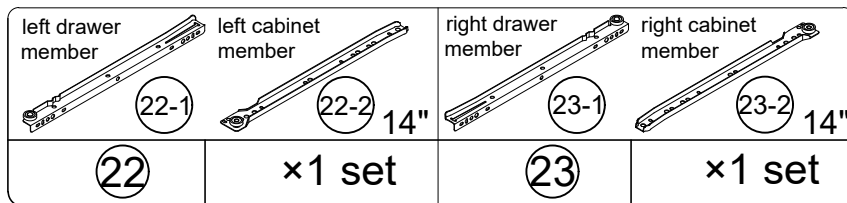

METAL SLIDE
TGO4513

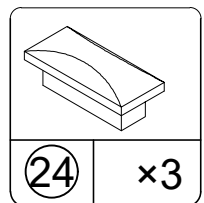

HANDLE
TGO5510

STEP 1

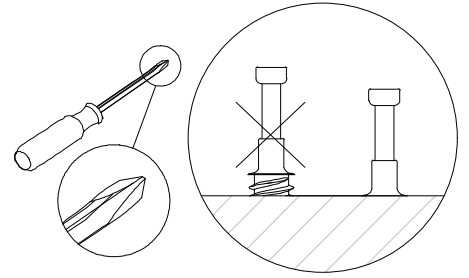
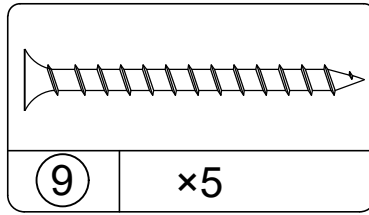
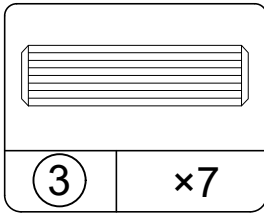
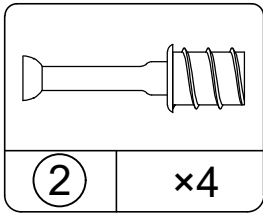

- 1.1 Screw (2) into (A) as illustrated.
- 1.2 Attach (D) & (E) to (A) with (3) & (9) as illustrated.
- 1.3 Insert (3) into (V) as illustrated.

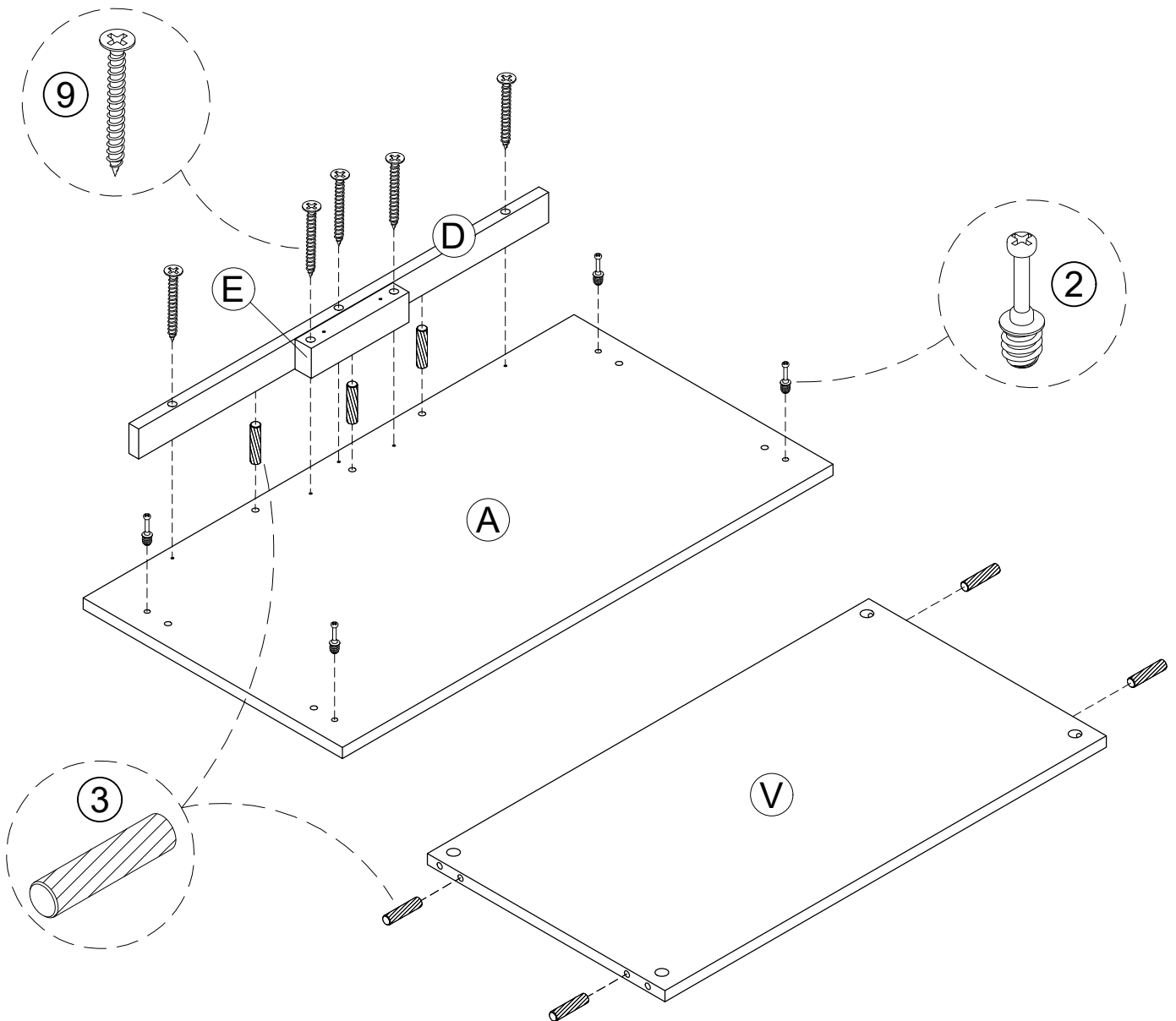

STEP 2

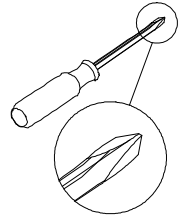
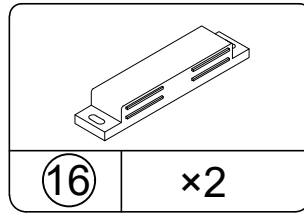
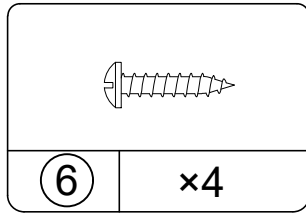
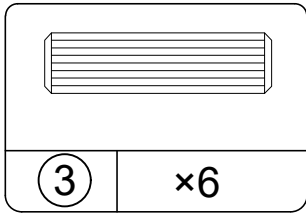

- 2.1 Insert (3) into (F) as illustrated.
- 2.2 Attach (16) to (E) & (F) with (6) as illustrated.

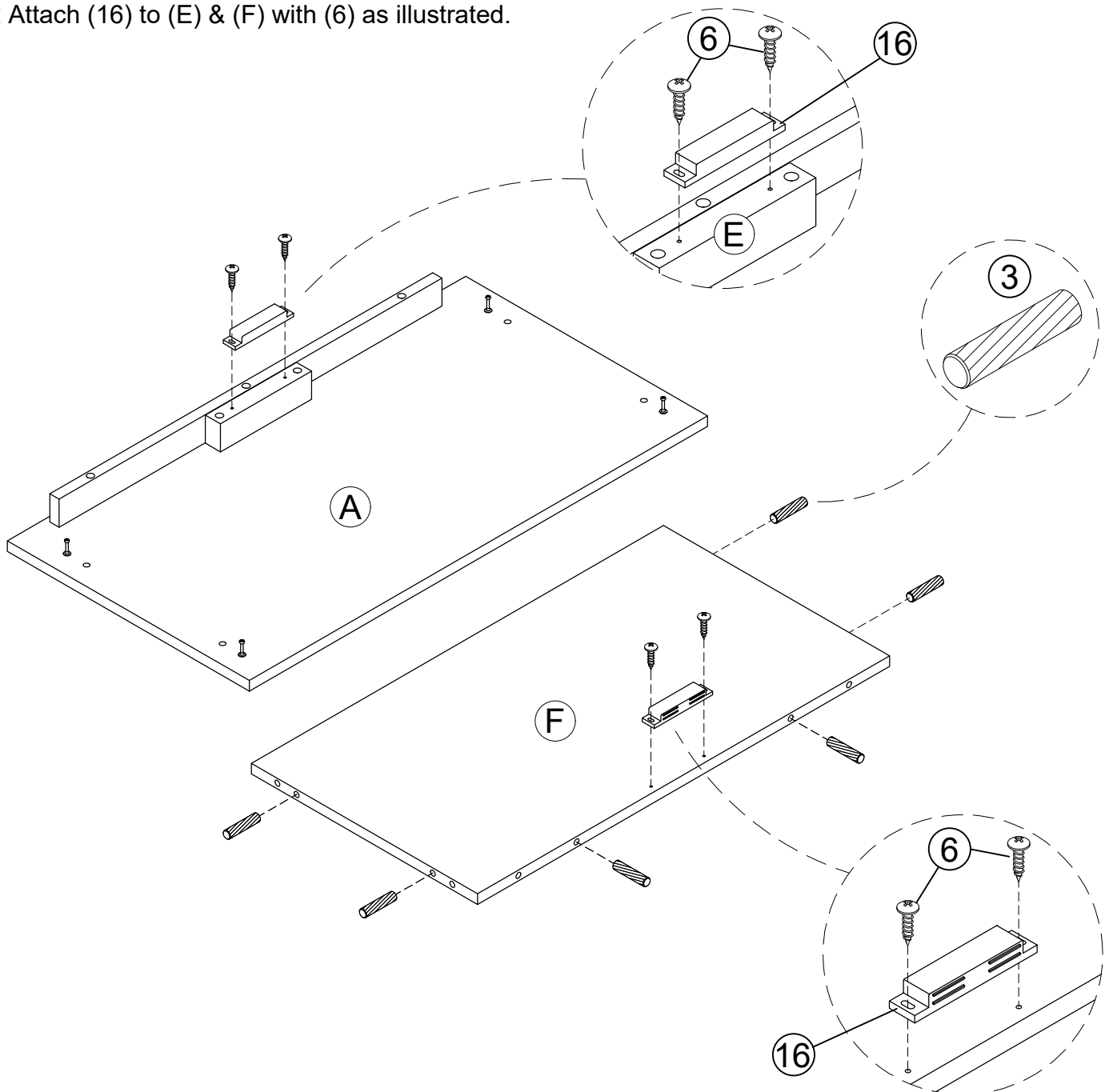

STEP 3

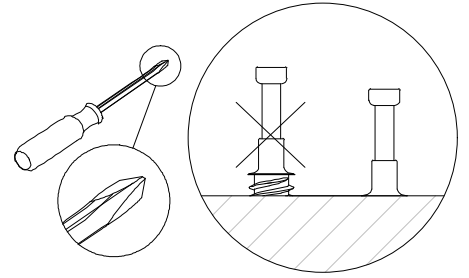
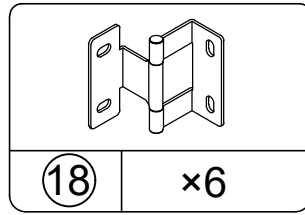
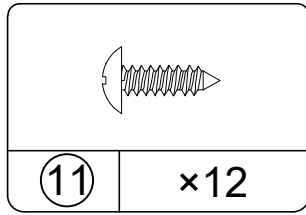
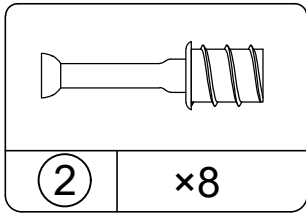

3.1 Screw (2) into (O) & (P) as illustrated.

3.2 Attach (18) to (O) & (P) with (11) as illustrated.

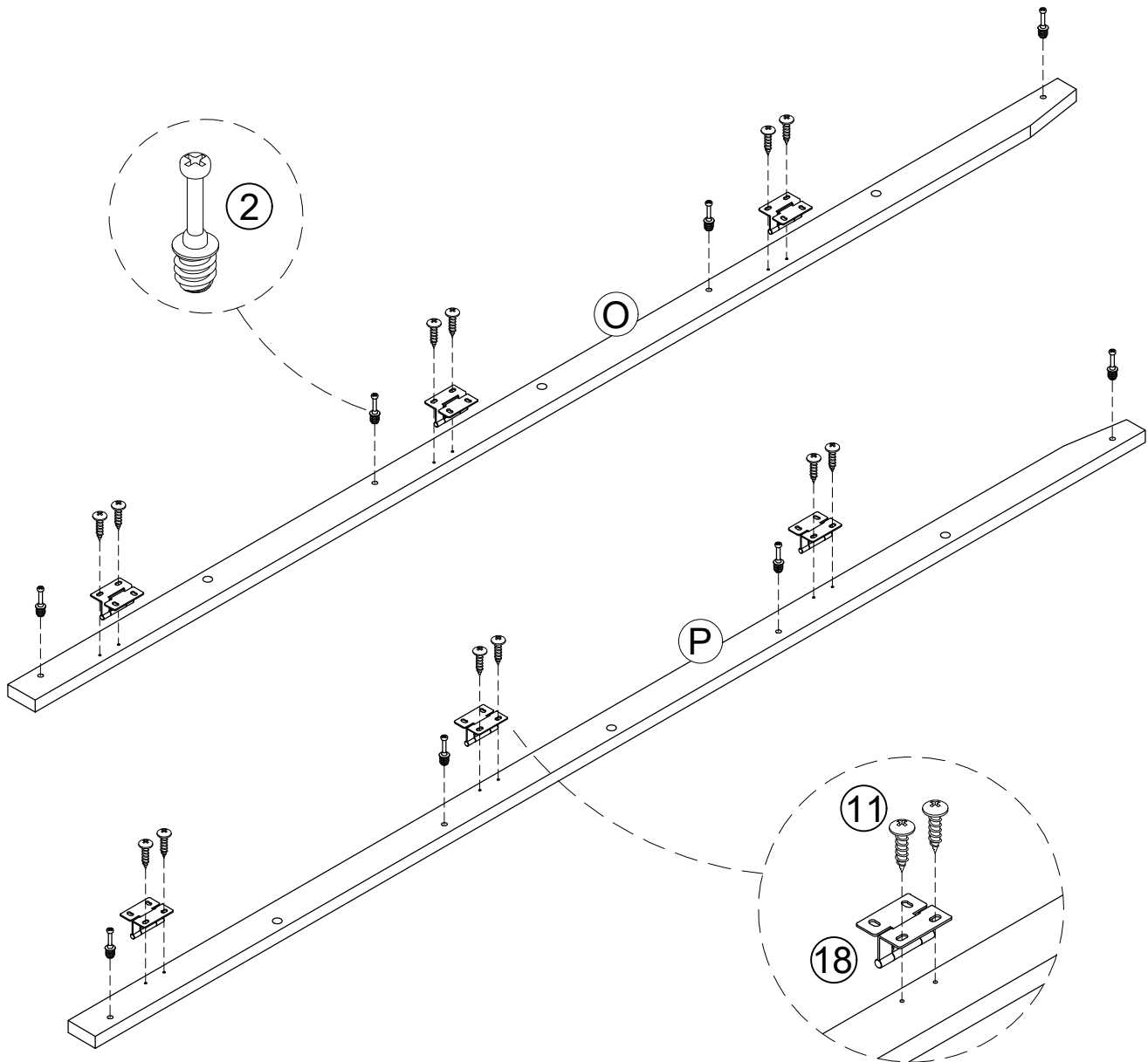

STEP 4

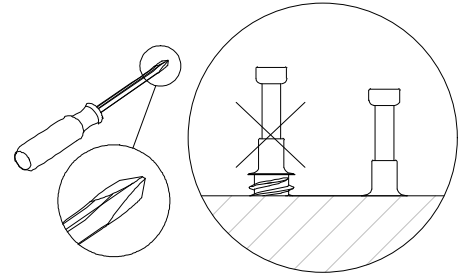
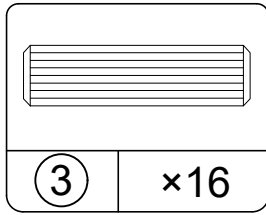
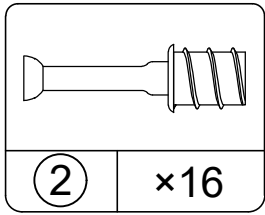

- 4.1 Screw (2) into (B), (C) & (G) as illustrated.
 4.2 Insert (3) into (B), (C), (R) & (S) as illustrated.

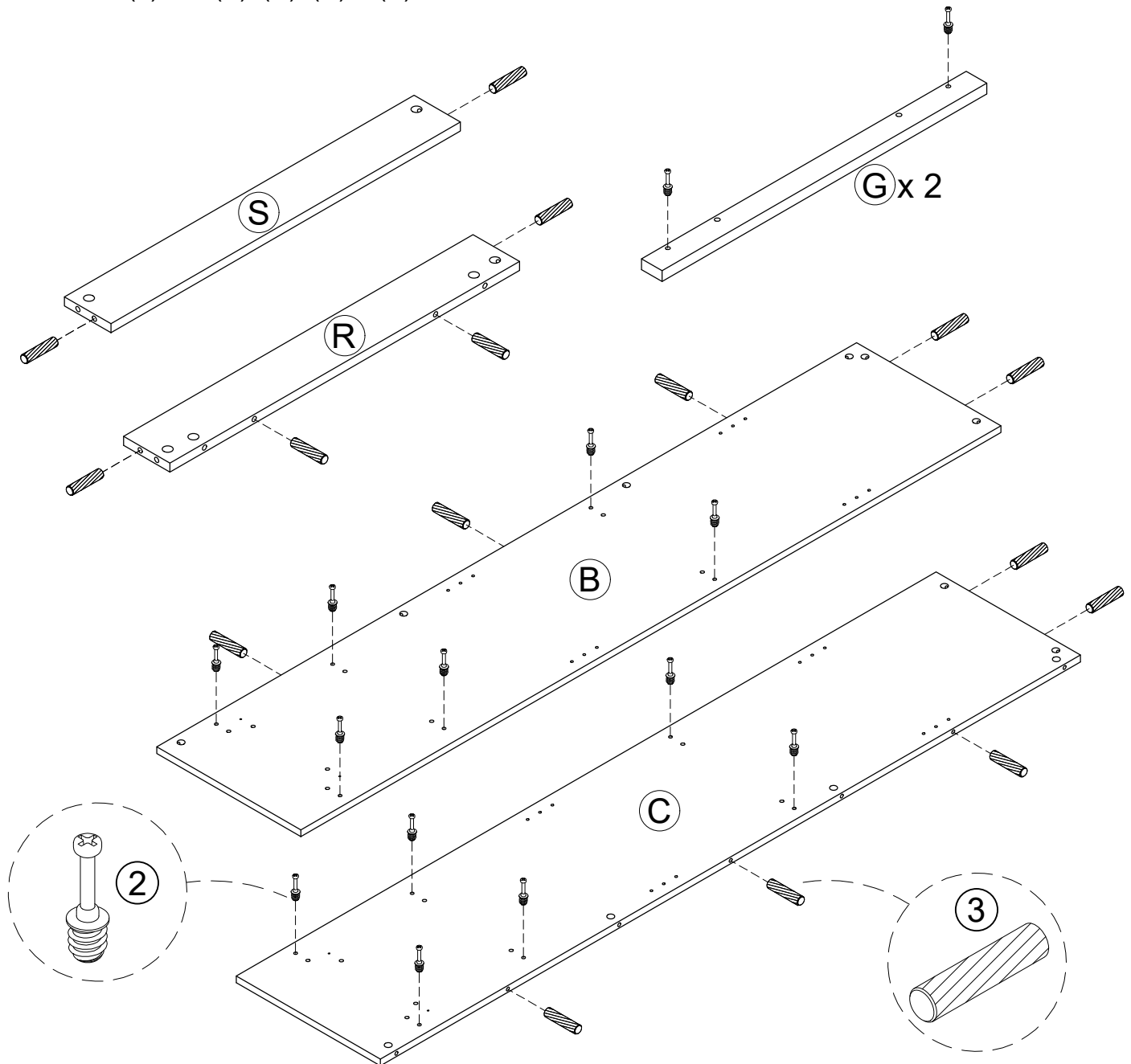

STEP 5

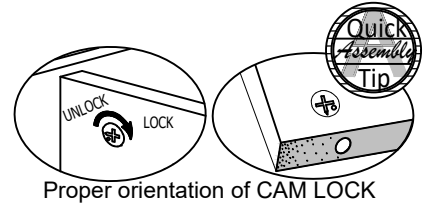
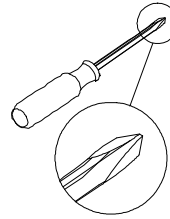
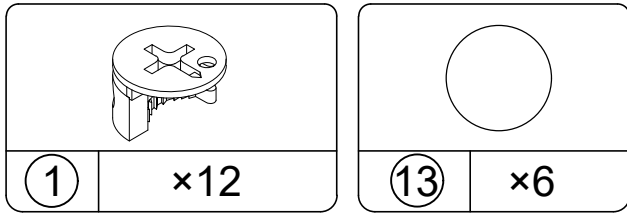

- 5.1 Attach (O) to (B) with (1) as illustrated.
- 5.2 Attach (P) to (C) with (1) as illustrated.
- 5.3 Attach (G) to (F) & (R) with (1) as illustrated.

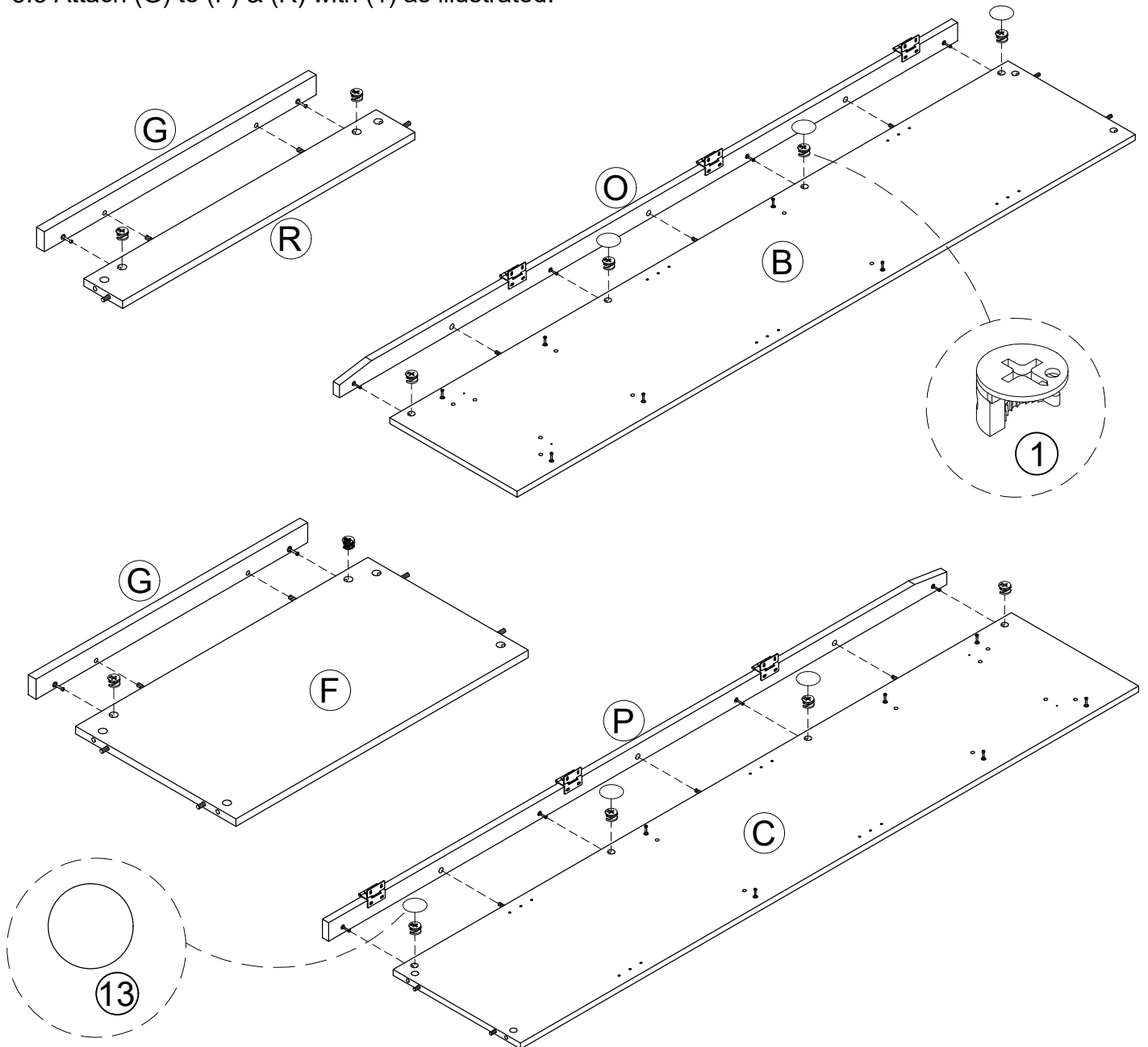

STEP 6

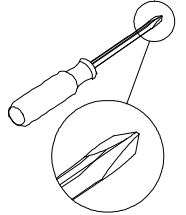
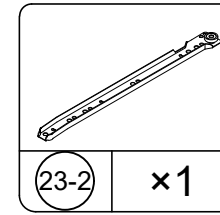
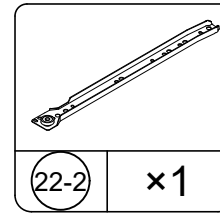
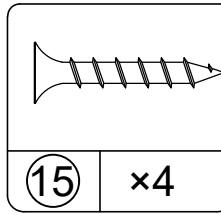
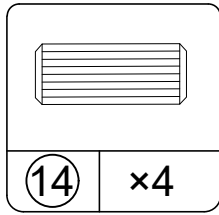
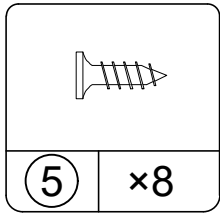

6.1 Attach (N) to (B) & (C) with (14) & (15) as illustrated.
6.2 Attach (22-2) & (23-2) to (N) with (5) as illustrated.

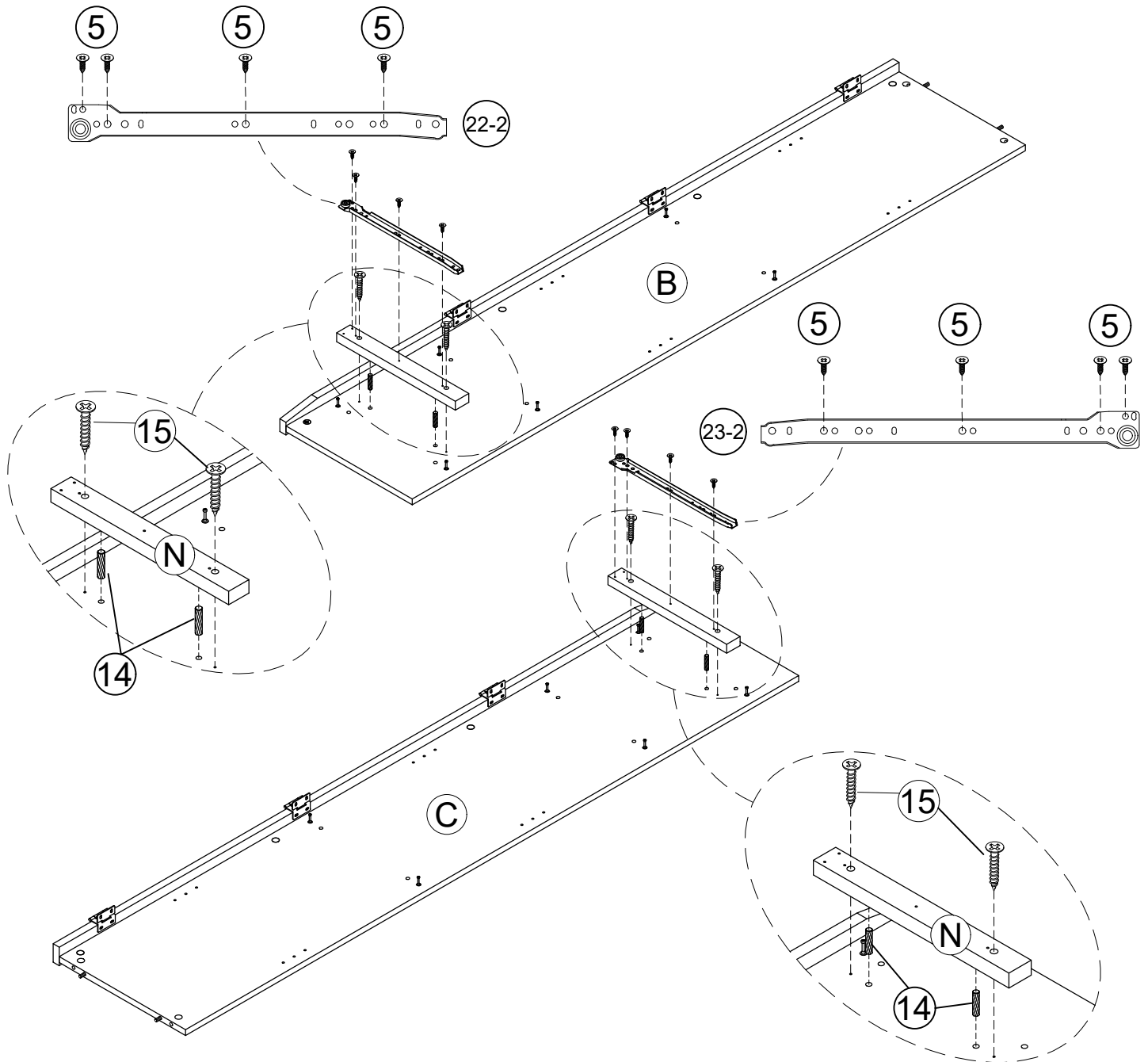

STEP 7

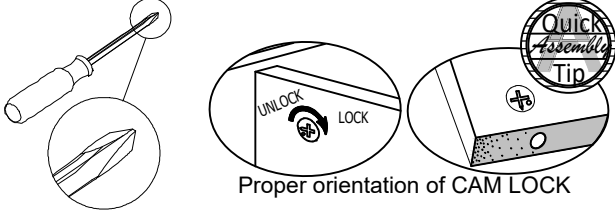
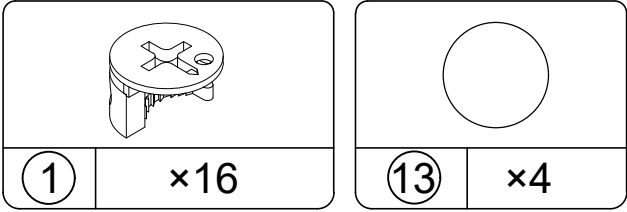

- 7.1 Attach (F), (R), (S) & (V) to (B) & (C) with (1) as illustrated.
- 7.2 Attach (A) to sub-assembly B/C/F/V from previous step with (1) as illustrated.

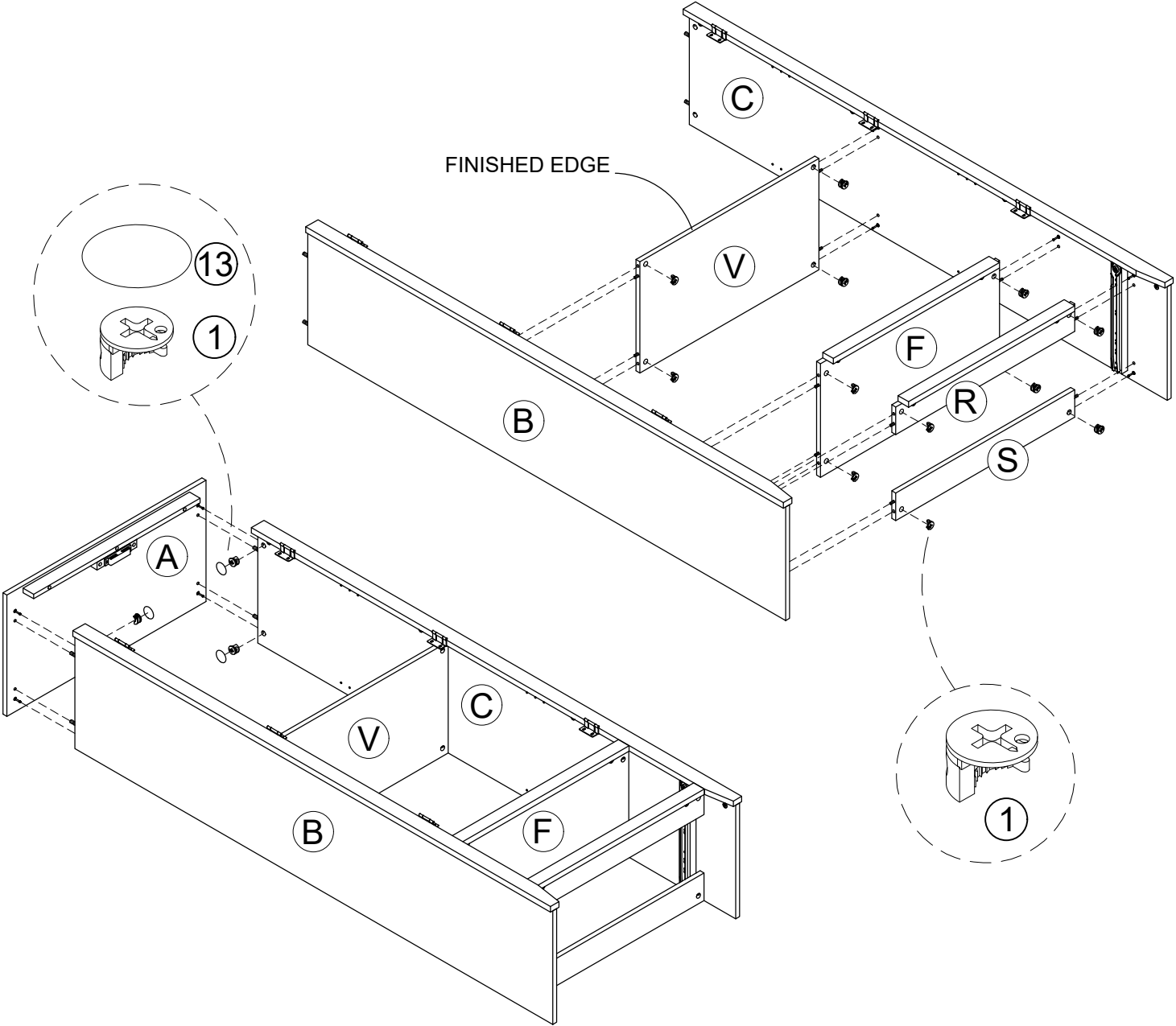

STEP 8

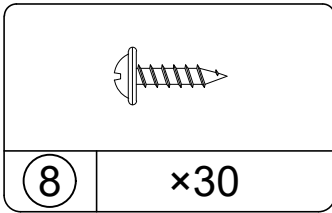

IMPORTANT! THE BACK PANEL IS A STRUCTURAL PART OF THIS UNIT AND MUST BE INSTALLED PROPERLY.

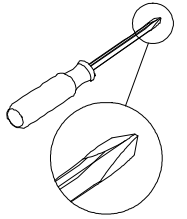

8.1 Attach (U) to sub-assembly A/B/C/F from previous step with (8) as illustrated.

* Assure that the unit is square. Distance from corner to corner must be equal as shown.

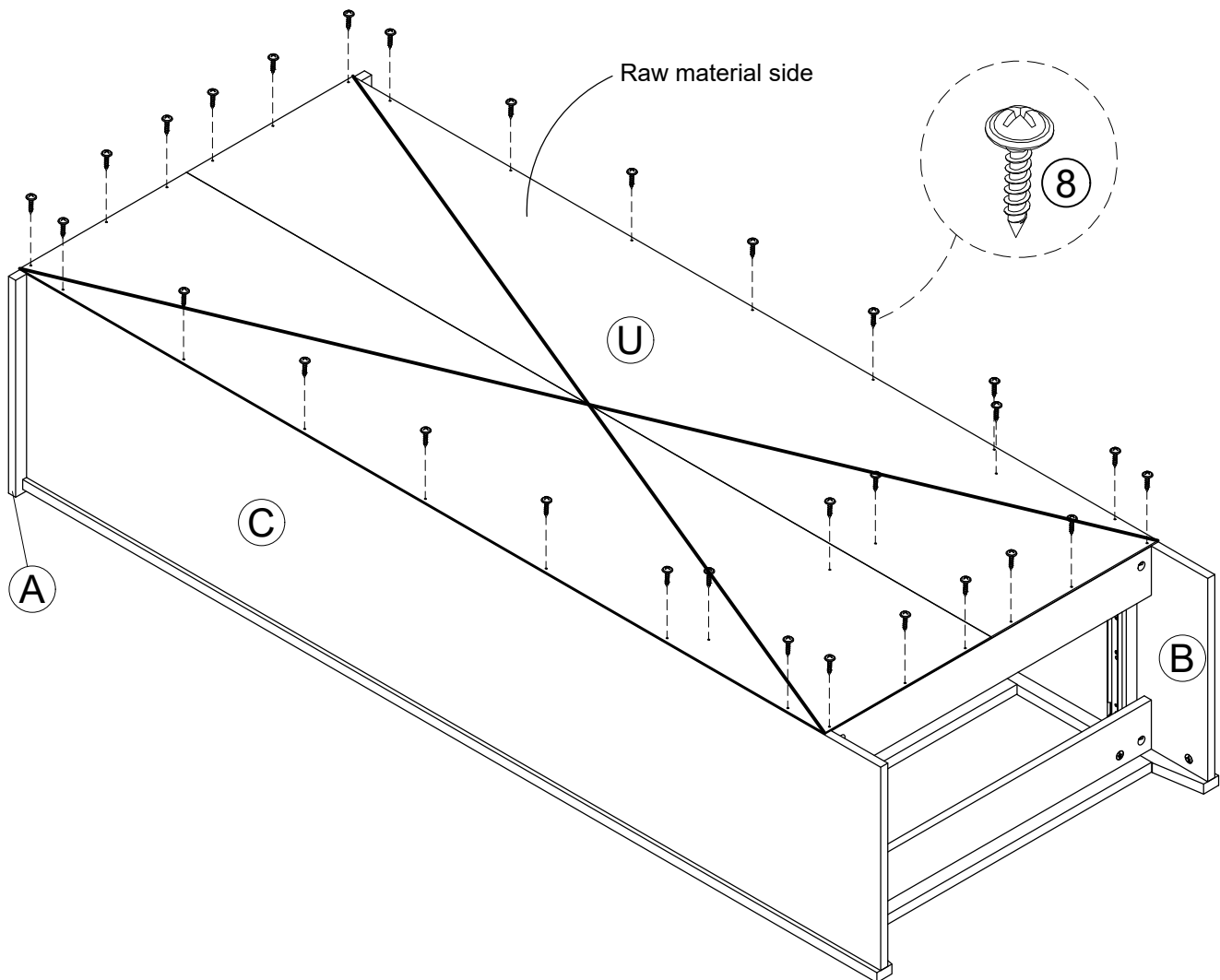

STEP 9

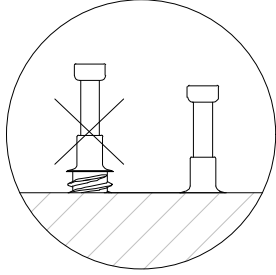
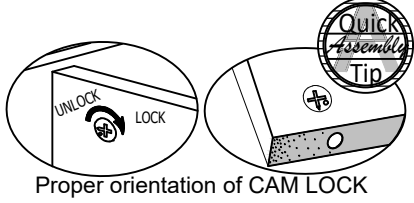
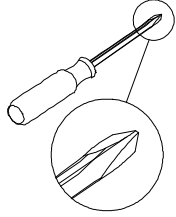
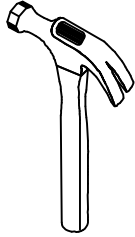
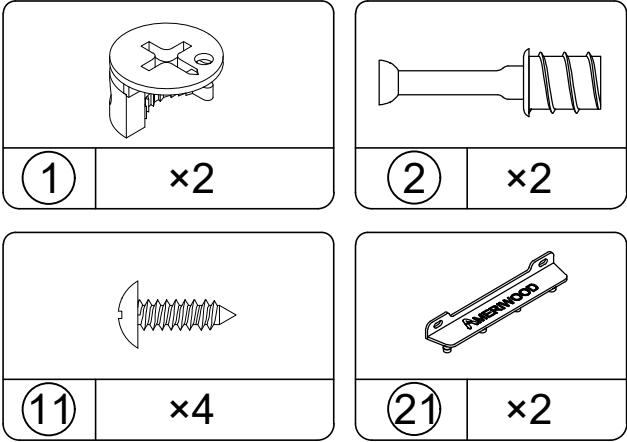

- 9.1 Insert (21) into (J) & (K) as illustrated.
- 9.2 Screw (2) into (I) as illustrated.
- 9.3 Attach (T) to (I) with (1) as illustrated.
- 9.4 Attach (J) & (K) to (I) with (11) as illustrated.

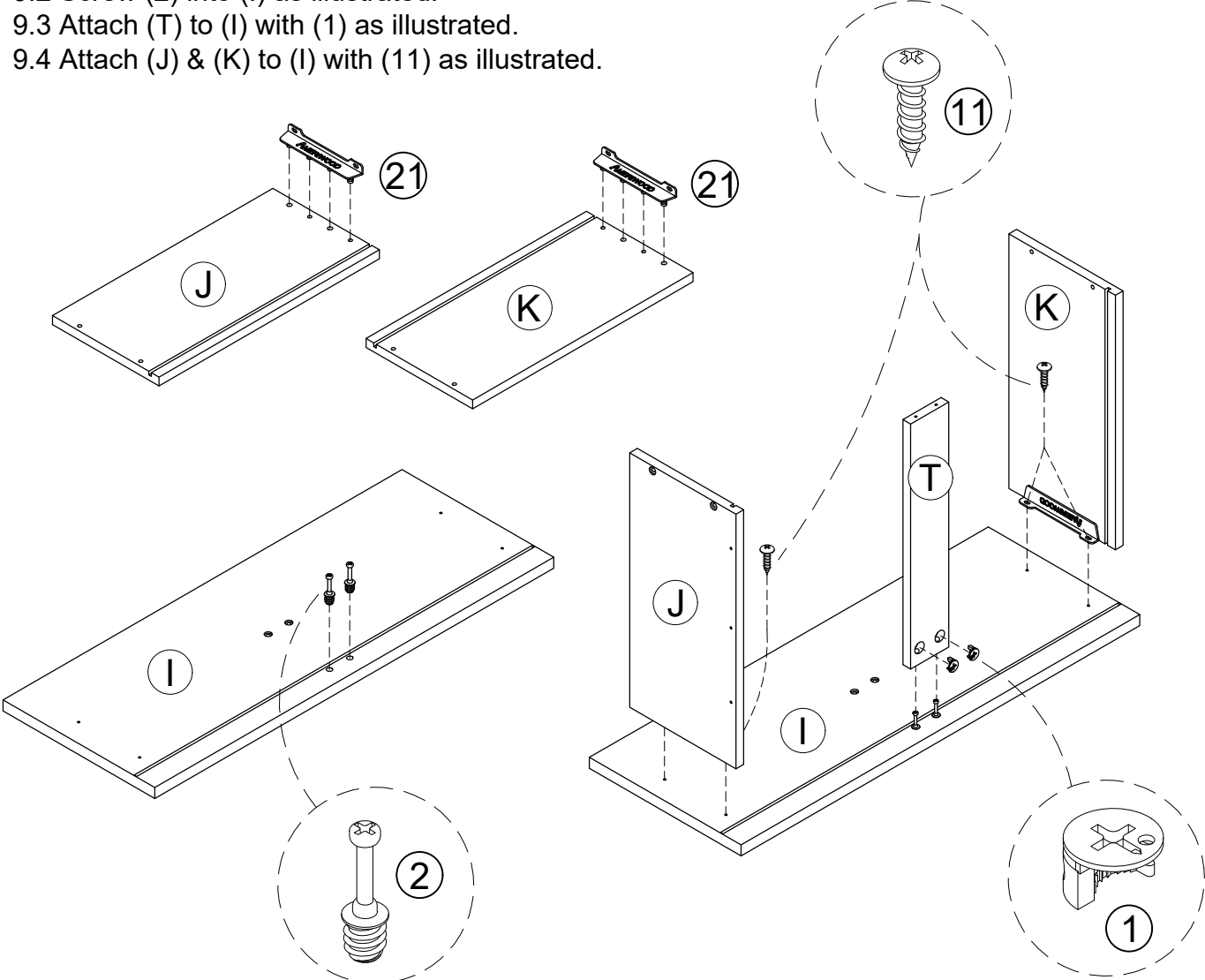

STEP 10

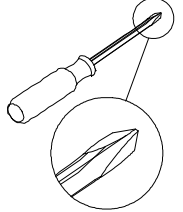
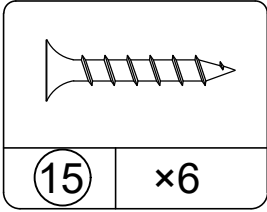
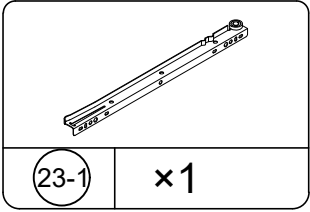
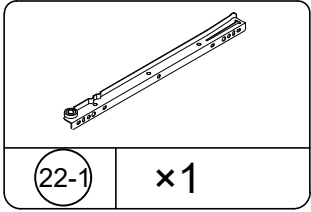
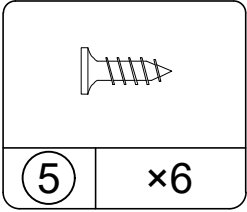

- 10.1 Insert (M) into (J), (K) & (I) as illustrated.
- 10.2 Attach (L) to (J), (K) & (T) with (15) as illustrated.
- 10.3 Attach (22-1) & (23-1) to (J) & (K) with (5) as illustrated.

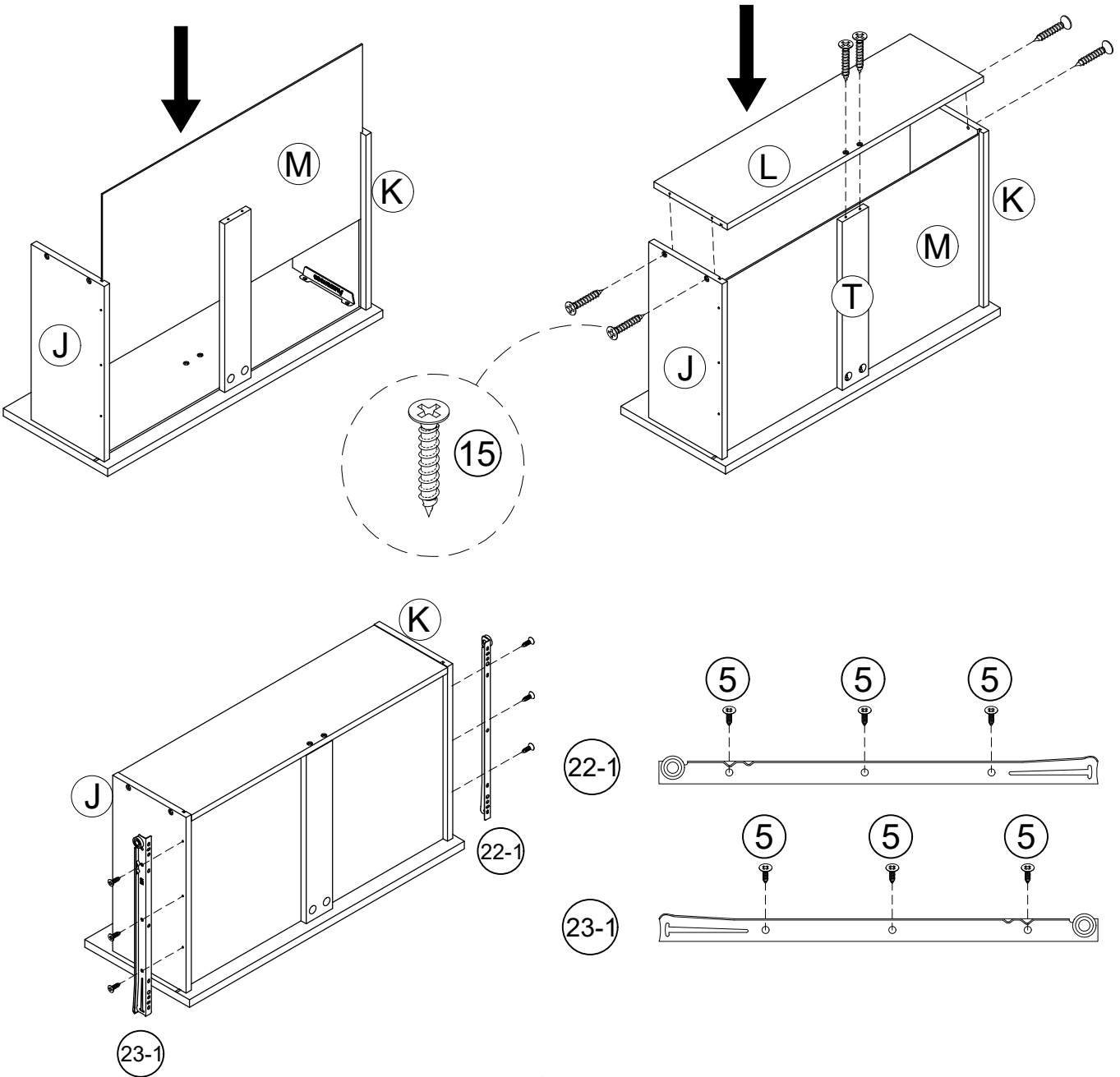

STEP 11

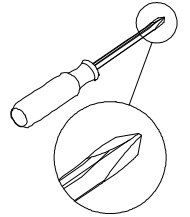
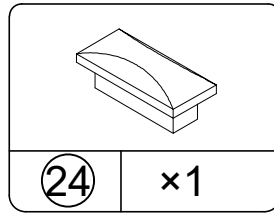
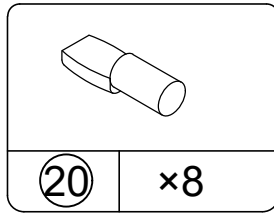
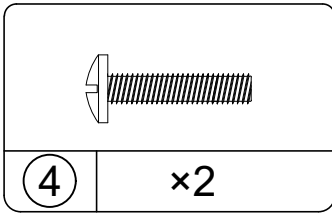

11.1 Attach (24) to (I) with (4) as illustrated.

11.2 Insert the shelf supports (20) at the desired level and place the adjustable shelves (H) onto the shelf supports.

11.3 Push the drawer into cabinet as illustrated.

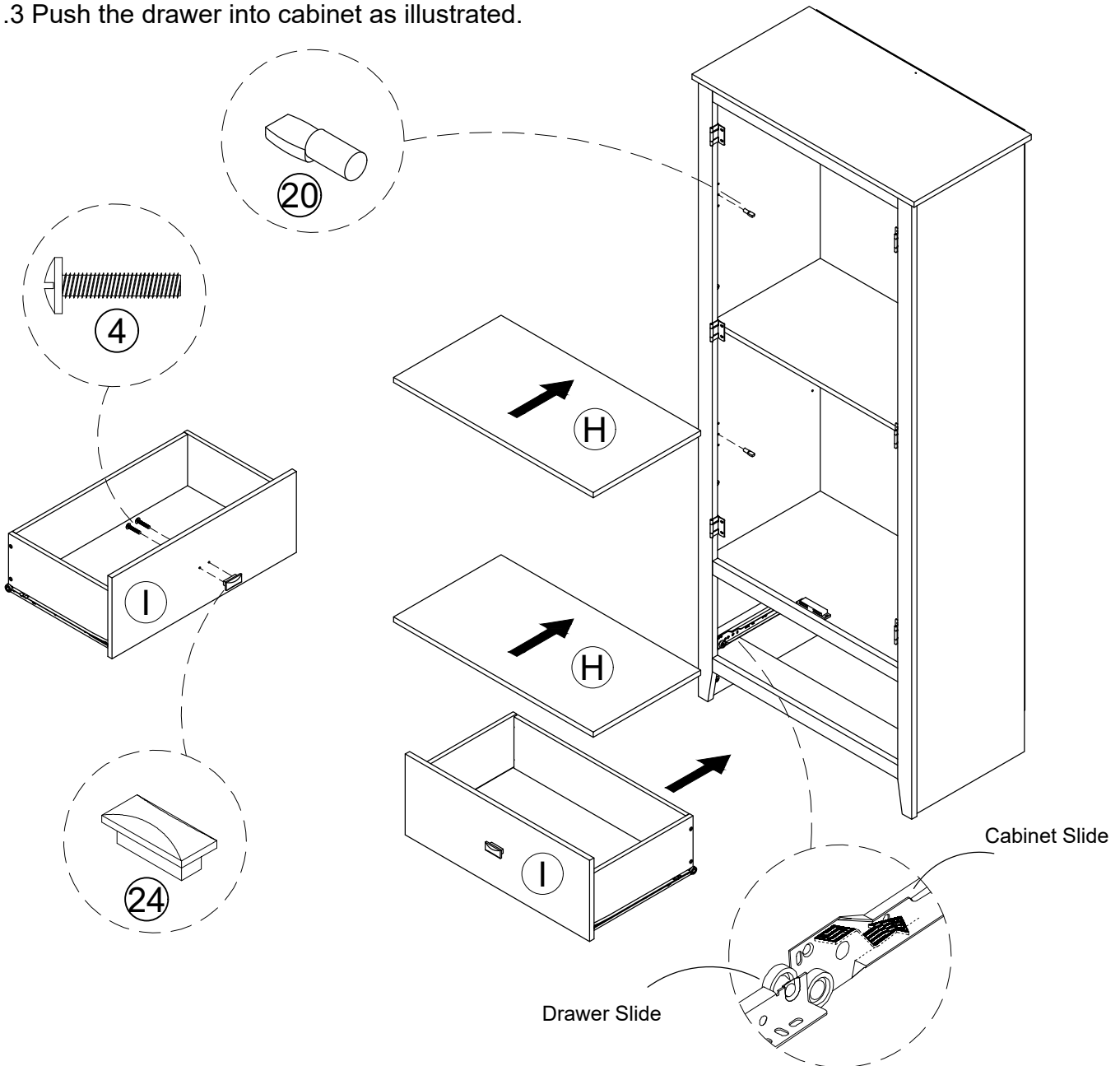

STEP 12

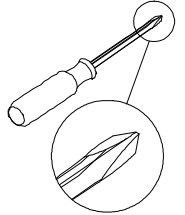
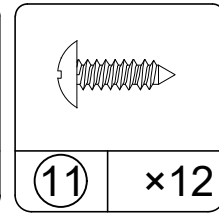
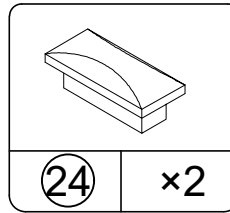
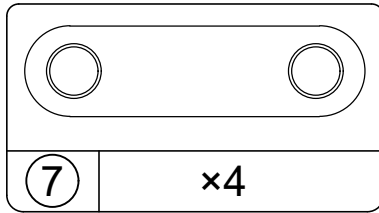
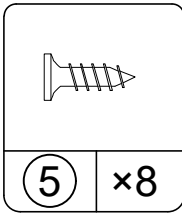
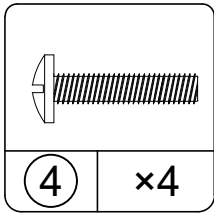

12.1 Attach (Q) to sub-assembly A/B/C/F from previous step with (11) as illustrated.

12.2 Attach (7) to (Q) with (5) as illustrated.

12.3 Attach (24) to (Q) with (4) as illustrated.

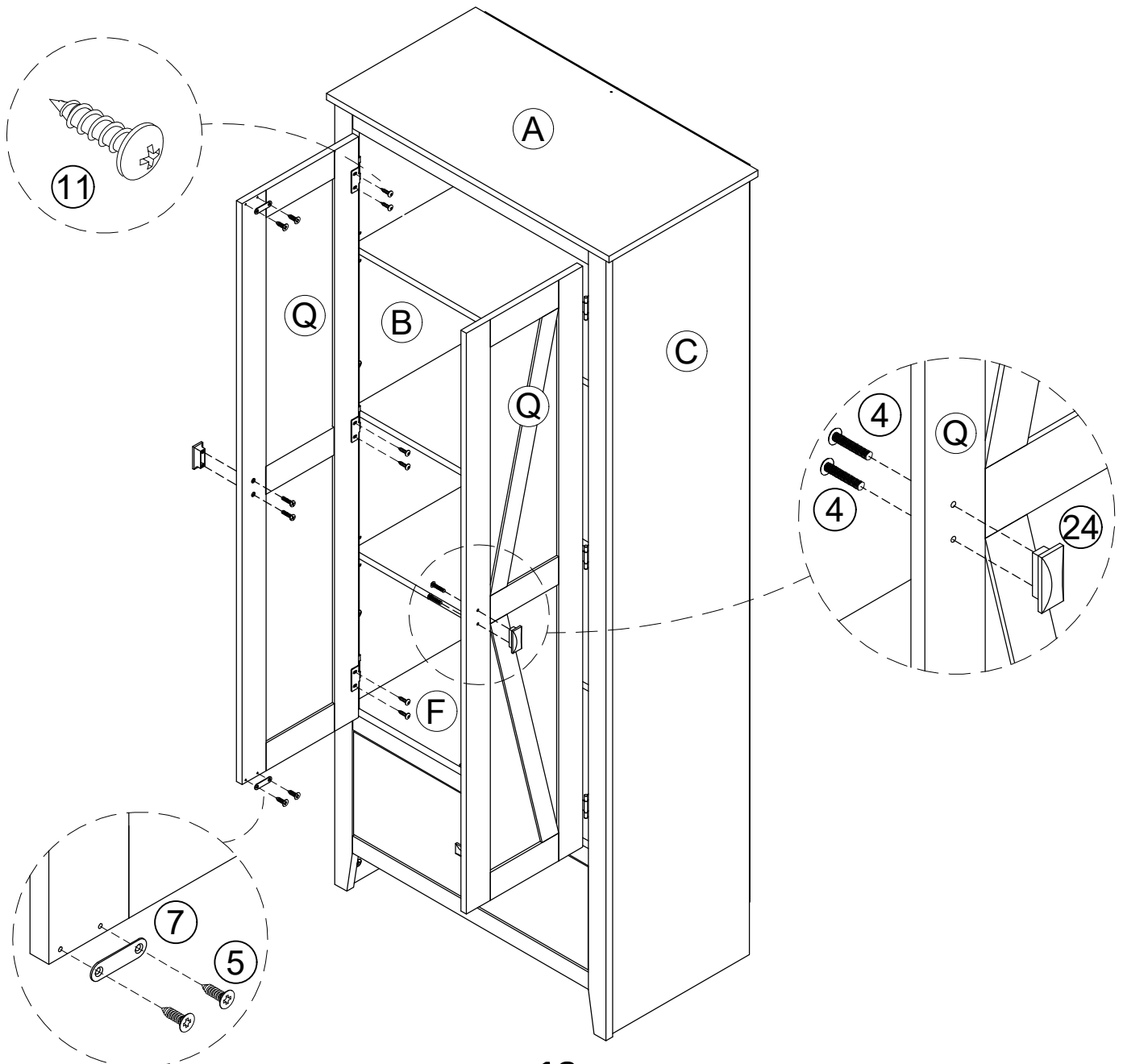

STEP 13

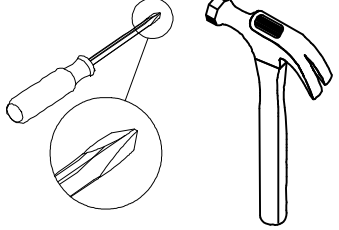
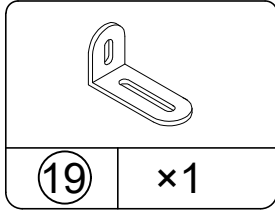
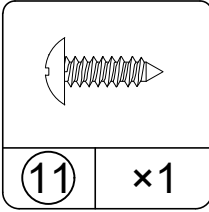
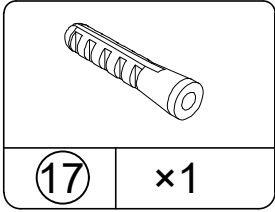
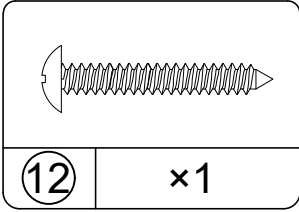

IMPORTANT: THIS UNIT MUST BE SECURE TO THE WALL TO HELP PREVENT TIPOVER. FOLLOW THESE INSTRUCTIONS TO INSTALL THE ANTI-TIPPING SAFETY BRACKET PROVIDED WITH THIS PRODUCT.

- 13.1 Drill a 3/16" (5mm) diameter hole in the wall. Tap the wall anchor (17) into the hole until it is flush.
- 13.2 Fasten wall bracket (19) to wall anchor (17) with screw (12). Make sure screw (11) is fully tightened.

For Masonry, Concrete, or other wall materials:
Consult your local hardware store for appropriate anchors to securely attach the safety bracket

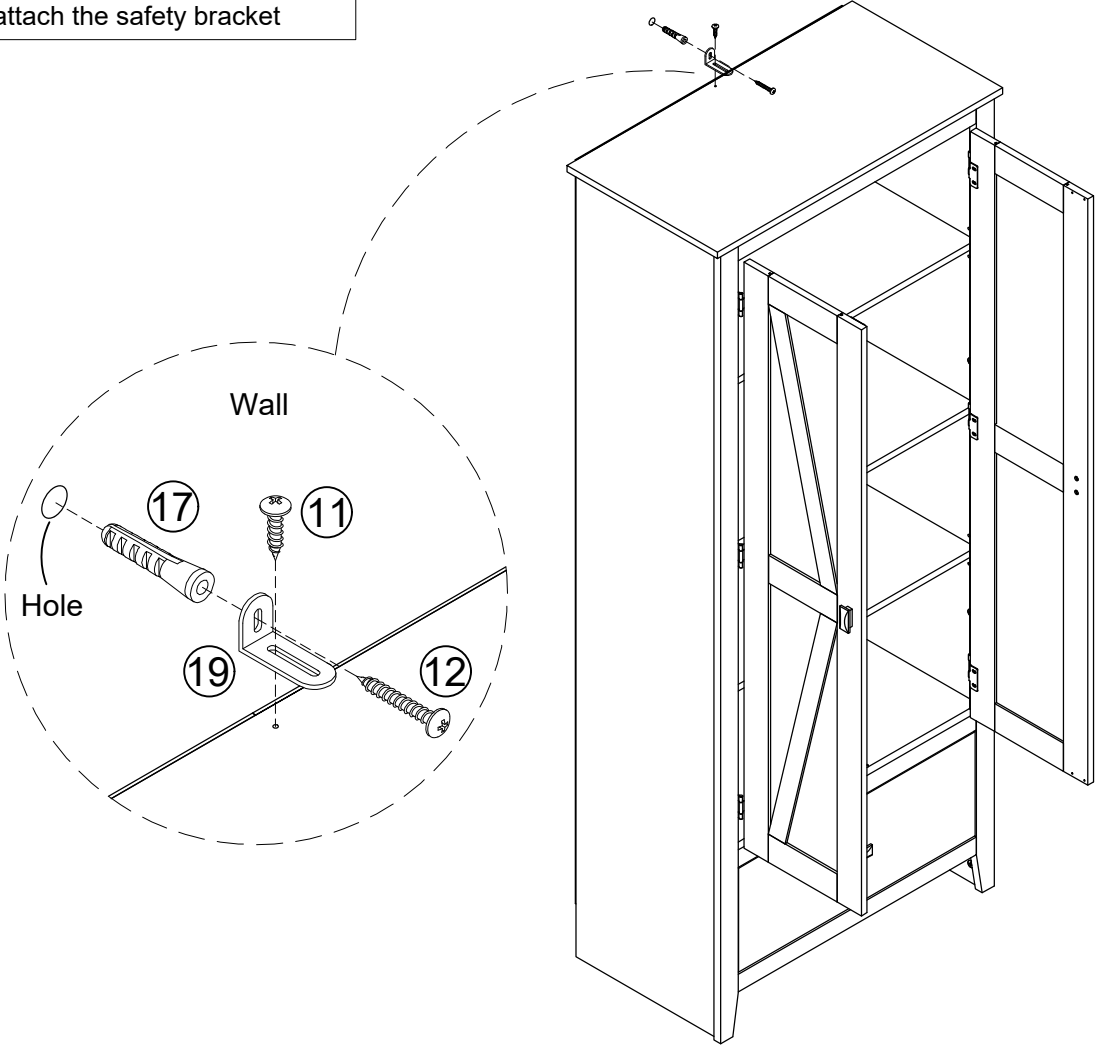

STEP 14

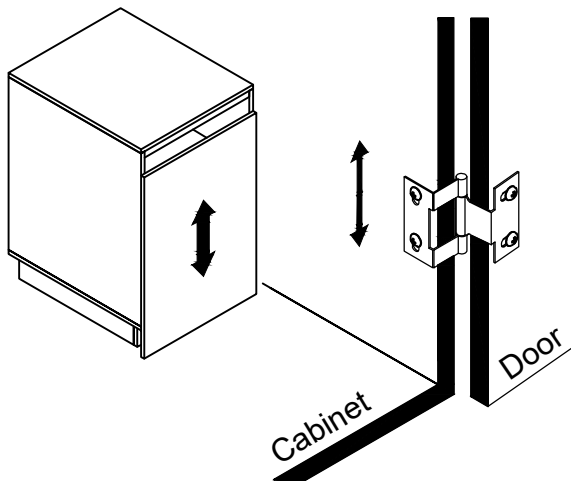
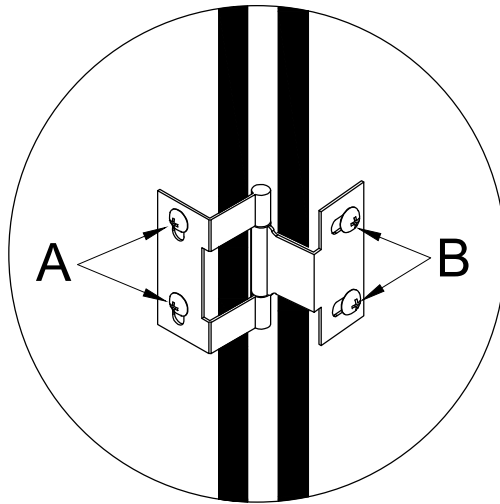

To adjust the vertical height.
Loosen screw "A" and adjust door.
Tighten screw "A".

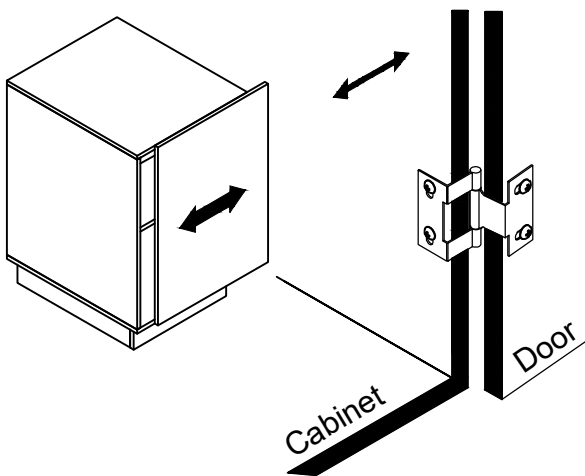

To adjust side ways.
Loosen screw "B" and adjust door.
Tighten screw "B".

Maximum Loads

This unit has been designed to support the maximum loads shown. Exceeding these load limits could cause sagging, instability, product collapse, and/or serious injury.

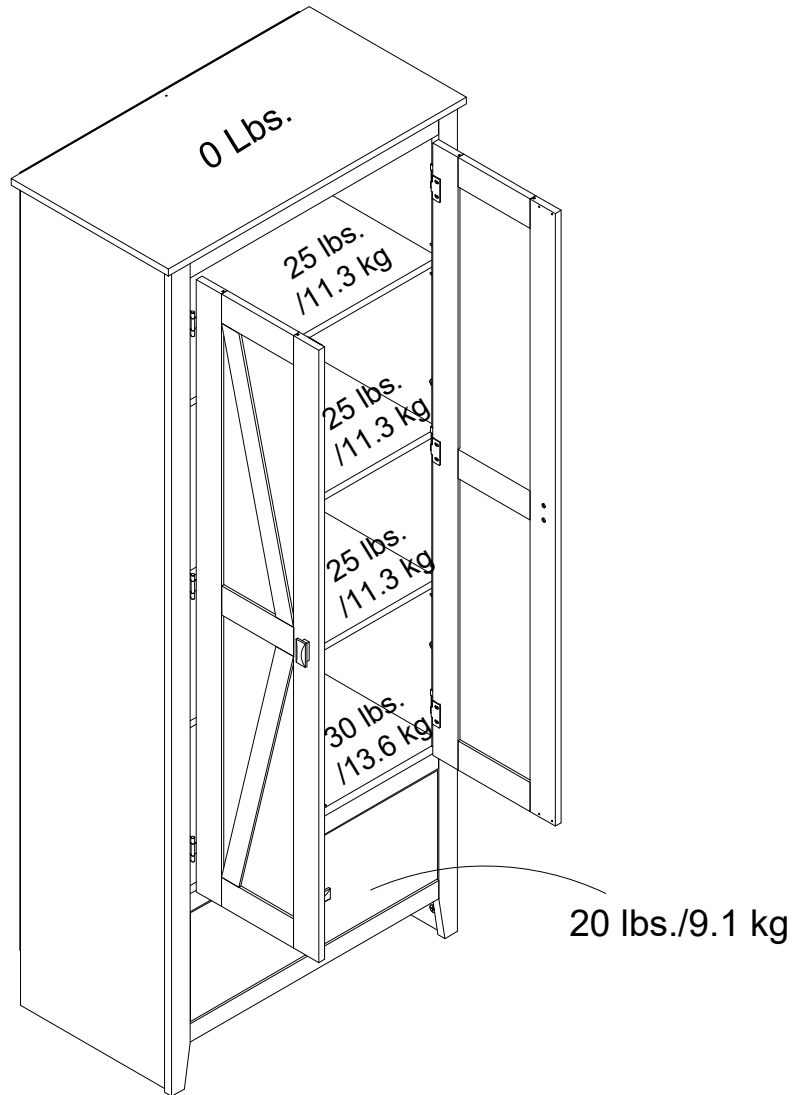

Warning: Risk of injury to persons - do not place a television on this furniture. This furniture is not approved for use with a television.

Certificate of Conformity

1. This certificate applies to the Dorel Home Furnishings, Inc. product identified by this instruction manual.
2. This certificate applies to compliance of this product with the CPSC Ban on Lead-Containing Paint (16 CFR 1303).
3. This product is distributed by: Dorel Home Furnishings, Inc.
410 East First Street South
Wright City, MO 63390
636-745-3351
4. Site of Manufacture: Binh Duong, Viet Nam.
5. See front page of instruction manual for date of manufacture.

Register your product to receive the following:



- * New trend details - sneak peek on what's new
- * Surveys - have a voice within our community
- * Exclusive deals and discount codes
- * Quick and easy replacement part service

To register your product, visit ameriwoodhome.com

5 Star Rating



Visit your local retailer's website, rate your purchased product and leave us some feedback!

We would like to extend a big "Thank You" to all of our customers for taking the time to assemble this Ameriwood Home product, and to give us your valuable feedback.

Thank You!

Cubierta Delantera

Este libro de instrucciones contiene información **IMPORTANTE** de seguridad. Por favor lea y manténgalo para referencia en el futuro.

No Regrese este producto! Comuníquese con nuestro amistoso equipo de servicio al cliente para obtener ayuda.

Llámenos al: 1-800-489-3351 (Gratis)

Visitar: www.ameriwoodhome.com

PRECAUCION

Este mueble puede volcarse y causar graves heridas y/o muerte.

Anclar el mueble a un poste de madera en la pared (si esto se requiere).

No Permita que los niños monten el mueble.

Mantenga los artículos más pesados en los cajones de abajo.

Consejos Útiles (página 2)

- Abra su artículo en el área donde usted planea utilizarlo para evitar levantar y moverlo menos
- Identificar, ordenar y contar las piezas antes de intentar ensamblar
- Las clavijas de compresión se golpean con un martillo
- Las diapositivas están marcadas con una R (derecha) y L (izquierda) para la colocación correcta
- Asegúrese de que siempre este el punto localizado en la parte superior de bloqueador de leva este volteado hacia borde exterior
- Utilizar todos los clavos para el panel de atrás y distribuirlos por igual
- El panel de atrás debe utilizarse para asegurarse de que la unidad quede fija y firme
- No use químicas fuertes ni limpiadores abrasivos en este artículo
- Nunca empuje, tire ni arrastre los muebles

Antes de Que Empieces (página 3)

- Lea cuidadosamente cada paso y siga el orden correcto

- Separar y contar todas sus piezas y hardware

- Dése suficiente espacio para el proceso de ensamble

- Tenga las siguientes herramientas: destornillador de cabeza plana, #2 cabeza Phillips

Destornillador y martillo

- Precaución: Si usa un taladro electrónico o un destornillador eléctrico para atornillar, por favor asegúrese que deje de atornillar cuando el tornillo este apretado. Fallar hacer esto puede causar barrer el tornillo.

Sistema de fijar el bloqueo de leva (página 3)

Esta sistema de fijar el bloqueo de leva sera usado en todo el proceso ensamble.

**Identificación de los Paneles
(Página 4-5)**

Este no es el tamaño real

- (A) ARRIBA
- (B) PANEL LATERAL IZQUIERDO
- (C) PANEL LATERAL DERECHO
- (D) DELANTAL SUPERIOR
- (E) BLOQUE DE MADERA
- (F) ESTANTE FIJO
- (G) DELANTAL INFERIOR
- (H) ESTANTE AJUSTABLE
- (I) FRENTE DE CAJÓN
- (J) LADO DEL CAJÓN DERECHO
- (K) LADO DEL CAJÓN IZQUIERDO
- (L) PARTE POSTERIOR DEL CAJÓN
- (M) PARTE INFERIOR DEL CAJÓN
- (N) BLOQUE DE CAJONES
- (O) DELANTAL IZQUIERDO
- (P) DELANTAL DERECHO
- (Q) PUERTA
- (R) PANEL INFERIOR DELANTERO
- (S) PANEL INFERIOR TRASERO
- (T) SOPORTE DE CAJONES
- (U) PANEL TRASERO
- (V) ESTANTE FIJO

Lista de Piezas (Página 6)

Tamaño real

- (1) Bloqueo de leva
- (2) Perno de leva
- (3) Pasador de madera
- (4) Perno
- (5) Tornillo
- (6) Tornillo
- (7) Placa de impacto
- (8) Tornillo
- (9) Tornillo
- (11) Tornillo
- (12) Tornillo
- (13) Funda
- (14) Pasador de madera
- (15) Tornillo

Este no es el tamaño real

- (16) Pestillo magnético
- (17) Anclaje de pared
- (18) Bisagra
- (19) Soporte de pared
- (20) Soporte de balda
- (21) Soporte de cajón
- (22) Corredera de metal
- (23) Corredera de metal
- (24) Mango

Página 7

- 1.1 Atornille (2) en (A) como se ilustra.
- 1.2 Conecte (D) y (E) a (A) con (3) y (9) como se ilustra.
- 1.3 Inserte (3) en (V) como se ilustra.

Página 8

- 2.1 Inserte (3) en (F) como se ilustra.
- 2.2 Conecte (16) a (E) y (F) con (6) como se ilustra.

Página 9

- 3.1 Atornille (2) en (O) y (P) como se ilustra.
- 3.2 Conecte (18) a (O) y (P) con (11) como se ilustra.

Página 10

- 4.1 Atornille (2) en (B), (C) y (G) como se ilustra.
- 4.2 Inserte (3) en (B), (C), (R) y (S) como se ilustra.

Página 11

- 5.1 Conecte (O) a (B) con (1) como se ilustra.
- 5.2 Conecte (P) a (C) con (1) como se ilustra.
- 5.3 Conecte (G) a (F) y (R) con (1) como se ilustra.

Página 12

6.1 Conecte (N) a (B) y (C) con (14) y (15) como se ilustra.

6.2 Conecte (22-2) y (23-2) a (N) con (5) como se ilustra.

Página 13

7.1 Conecte (F), (R), (S) y (V) a (B) y (C) con (1) como se ilustra.

7.2 Conecte (A) al subconjunto B / C / F / V del paso anterior con (1) como se ilustra.

Página 14

8.1 Conecte (U) al subconjunto A / B / C / F del paso anterior con (8) como se ilustra.

* Asegúrese de que la unidad sea cuadrada. La distancia de esquina a esquina debe ser igual a la que se muestra.

¡IMPORTANTE! EL PANEL TRASERO ES UNA PARTE ESTRUCTURAL DE ESTA UNIDAD Y SE DEBE INSTALAR CORRECTAMENTE.

Página 15

9.1 Inserte (21) en (J) y (K) como se ilustra.

9.2 Atornille (2) en (I) como se ilustra.

9.3 Conecte (T) a (I) con (1) como se ilustra.

9.4 Conecte (J) y (K) a (I) con (11) como se ilustra.

Página 16

10.1 Inserte (M) en (J), (K) y (I) como se ilustra.

10.2 Conecte (L) a (J), (K) y (T) con (15) como se ilustra.

10.3 Conecte (22-1) y (23-1) a (J) y (K) con (5) como se ilustra.

Página 17

11.1 Conecte (24) a (I) con (4) como se ilustra.

11.2 Inserte los soportes del estante (20) al nivel deseado y coloque los estantes ajustables (H) sobre los soportes del estante.

11.3 Empuje el cajón dentro del gabinete como se muestra en la ilustración.

Página 18

12.1 Conecte (Q) al subconjunto A / B / C / F del paso anterior con (11) como se ilustra.

12.2 Conecte (7) a (Q) con (5) como se ilustra.

12.3 Conecte (24) a (Q) con (4) como se ilustra.

Página 19

IMPORTANTE: ESTA UNIDAD DEBE ESTAR FIJADA A LA PARED PARA AYUDAR A EVITAR QUE VUELCA. SIGA ESTAS INSTRUCCIONES PARA INSTALAR EL SOPORTE DE SEGURIDAD ANTIVUELCO SUMINISTRADO CON ESTE PRODUCTO.

13.1 Taladre un orificio de 3/16" (5 mm) de diámetro en la pared. Golpee suavemente el anclaje de pared (17) en el orificio hasta que quede al ras.

13.2 Fije el soporte de pared (19) al anclaje de pared (17) con el tornillo (12). Asegúrese de que el tornillo (11) esté completamente apretado.

Para mampostería, hormigón u otros materiales de pared: Consulte en su ferretería local los anclajes apropiados para sujetar de forma segura el soporte de seguridad.

Página 20

Ajuste de bisagra

Página 21

CARGA MAXIMA

Esta unidad ha sido diseñada para soportar la carga máxima anotada. El exceder estos límites puede causar inestabilidad, colapsarse y/o causar serias lesiones.

ADVERTENCIA: Riesgo de lesiones a las personas - no coloque un televisor sobre muebles. Este mueble no está aprobado para su uso con un televisor.

Página 22

Registre su producto para recibir lo siguiente:

- * Detalles de nuevas tendencias - Vistazo a lo nuevo
- * Encuestas - alec su voz entre su comunidad
- * Códigos de ofertas y descuentos exclusivos
- * Fácil y rápido servicio de partes de remplace

Para registrar su producto, visite ameriwoodhome.com

Clasificación de 5 estrellas

Visite el sitio web de su distribuidor local, califique el producto que compró y déjenos sus comentarios.

Nos gustaría enviar un gran "Agradecimiento" a todos nuestros clientes por tomarse el tiempo de ensamblar este producto de Ameriwood Home, y por darnos sus valiosos comentarios.

Gracias

Couverture Avant

CE LIVRET D'INSTRUCTION CONTIENT DES INFORMATIONS **IMPORTANTES** SUR LA SÉCURITÉ.
VEUILLEZ LIRE ET GARDER POUR UNE RÉFÉRENCE FUTURE

Ne retournez pas ce produit! Contactez notre équipe de service à la clientèle amicale d'abord pour obtenir de l'aide.

Appelez-nous: 1-800-489-3351 (sans frais)

Visitez: www.ameriwoodhome.com

ATTENTION

Le meuble peut basculer et causer des blessures graves ou la mort.

Ancrer le meuble à une planche murale dans le mur (si indiqué).

Ne laissez pas les enfants grimper sur le meuble.

Placez les articles lourds sur les étagères ou dans les tiroirs inférieurs.

Astuces Utiles (page 2)

- Ouvrez votre article dans la zone que vous prévoyez de le garder pour moins de levage lourd
- Identifier, trier et compter les pièces avant d'essayer d'assembler
- Les goujons de compression sont taraudés avec un Marteau
- Les glissières sont marquées d'un R (droit) et d'un L (gauche) pour un bon placement
- Assurez-vous toujours de faire face la pointe situé sur le haut de la Serrure de Came vers le bord extérieur
- Utiliser tous les clous fournis pour le panneau arrière et les répartir également
- Le panneau arrière doit être utilisé pour vous assurer que votre appareil est robuste
- N'utilisez pas de produits chimiques agressifs ou de nettoyeurs abrasifs sur cet appareil
- Ne jamais pousser, tirer, ou faire glisser votre meuble

Avant de Commencer (page 3)

- Lisez attentivement chaque étape et suivez le bon ordre
- Séparez et comptez toutes vos pièces et matériaux
- Donnez-vous suffisamment de place pour l'assemblage
- Avoir les outils suivants: tournevis à tête plate, #2 tournevis Phillips, et Marteau
- Attention: Si vous utilisez une perceuse électrique ou un tournevis électrique pour visser, veuillez à ralentir et arrêter lorsque la vis est bien serrée. Le non-respect de cette consigne peut endommager la vis.

Système de Fixation de Came (page 3)

Ce Système de Fixation de Came sera utilisé tout au long de l'assemblage.

Page 4-5: Identification du conseil

Pas la taille réelle

- (A) HAUT
- (B) PANNEAU LATÉRAL GAUCHE
- (C) PANNEAU CTÉ DROIT
- (D) TABLIER SUPÉRIEUR
- (E) BLOC DE BOIS
- (F) ÉTAGÈRE FIXE
- (G) TABLIER INFÉRIEUR
- (H) TABLETTE AJUSTABLE
- (I) DEVANT TIROIR
- (J) CTÉ TIROIR DROIT
- (K) CTÉ TIROIR GAUCHE
- (L) TIROIR ARRIÈRE
- (M) FOND DE TIROIR
- (N) BLOC TIROIR
- (O) TABLIER GAUCHE
- (P) TABLIER DROIT
- (Q) PORTE
- (R) PANNEAU INFÉRIEUR AVANT
- (S) PANNEAU INFÉRIEUR ARRIÈRE
- (T) SUPPORT DE TIROIR
- (U) PANNEAU ARRIÈRE
- (V) ÉTAGÈRE FIXE

Page 6 Liste des pièces

Taille actuelle

- (1) Serrure à came
- (2) Boulon à came
- (3) Cheville en bois
- (4) Boulon
- (5) Vis
- (6) Vis
- (7) Gâche
- (8) Vis
- (9) Vis
- (11) Vis
- (12) Vis
- (13) Couverture
- (14) Cheville en bois
- (15) Vis

Pas de taille réelle

- (16) Loquet magnétique
- (17) Ancrage mural
- (18) Charnière
- (19) Support mural
- (20) Support d'étagère
- (21) Support de tiroir
- (22) Glissière en métal
- (23) Glissière en métal
- (24) Poignée

Page 7

- 1.1 Visser (2) dans (A) comme illustré.
- 1.2 Fixez (D) et (E) à (A) avec (3) et (9) comme illustré.
- 1.3 Insérez (3) dans (V) comme illustré.

Page 8

- 2.1 Insérez (3) dans (F) comme illustré.
- 2.2 Fixez (16) à (E) et (F) avec (6) comme illustré.

Page 9

- 3.1 Visser (2) dans (O) et (P) comme illustré.
- 3.2 Fixez (18) à (O) et (P) avec (11) comme illustré.

Page 10

- 4.1 Visser (2) dans (B), (C) et (G) comme illustré.
- 4.2 Insérez (3) dans (B), (C), (R) et (S) comme illustré.

Page 11

- 5.1 Attachez (O) à (B) avec (1) comme illustré.
- 5.2 Fixez (P) à (C) avec (1) comme illustré.
- 5.3 Attachez (G) à (F) et (R) avec (1) comme illustré.

Page 12

6.1 Attachez (N) à (B) et (C) avec (14) et (15) comme illustré.

6.2 Fixez (22-2) et (23-2) à (N) avec (5) comme illustré.

Page 13

7.1 Attachez (F), (R), (S) et (V) à (B) et (C) avec (1) comme illustré.

7.2 Fixez (A) au sous-ensemble B/C/F/V de l'étape précédente avec (1) comme illustré.

Page 14

8.1 Fixez (U) au sous-ensemble A/B/C/F de l'étape précédente avec (8) comme illustré.

* Assurez-vous que l'unité est carrée. La distance d'un coin à l'autre doit être égale comme indiqué.

IMPORTANT! LE PANNEAU ARRIÈRE EST UNE PARTIE STRUCTURELLE DE CET APPAREIL ET DOIT ÊTRE INSTALLÉ CORRECTEMENT.

Page 15

9.1 Insérez (21) dans (J) et (K) comme illustré.

9.2 Visser (2) dans (I) comme illustré.

9.3 Attachez (T) à (I) avec (1) comme illustré.

9.4 Attachez (J) et (K) à (I) avec (11) comme illustré.

Page 16

10.1 Insérez (M) dans (J), (K) et (I) comme illustré.

10.2 Fixez (L) à (J), (K) et (T) avec (15) comme illustré.

10.3 Fixez (22-1) et (23-1) à (J) et (K) avec (5) comme illustré.

Page 17

11.1 Fixez (24) à (I) avec (4) comme illustré.

11.2 Insérez les supports de tablettes (20) au niveau souhaité et placez les tablettes réglables (H) sur les supports de tablettes.

11.3 Poussez le tiroir dans l'armoire comme illustré.

Page 18

12.1 Fixez (Q) au sous-ensemble A/B/C/F de l'étape précédente avec (11) comme illustré.

12.2 Fixez (7) à (Q) avec (5) comme illustré.

12.3 Fixez (24) à (Q) avec (4) comme illustré.

Page 19

IMPORTANT : CETTE UNITÉ DOIT ÊTRE FIXÉE AU MUR POUR ÉVITER TOUT BASCULEMENT.

SUIVEZ CES INSTRUCTIONS POUR INSTALLER LE SUPPORT DE SÉCURITÉ ANTI-BASCULEMENT FOURNI AVEC CE PRODUIT.

13.1 Percez un trou de 3/16" (5 mm) de diamètre dans le mur. Enfoncez l'ancrage mural (17) dans le trou jusqu'à ce qu'il soit à niveau.

13.2 Fixez le support mural (19) à l'ancrage mural (17) avec la vis (12). Assurez-vous que la vis (11) est bien serrée.

Pour la maçonnerie, le béton ou d'autres matériaux muraux : Consultez votre quincaillerie locale pour les ancrages appropriés pour fixer solidement le support de sécurité

Page 20

Réglage de la charnière

Page 21

CHARGES MAXIMALES

Ce meuble a été conçu pour supporter les charges maximales indiquées. En excédant ces limites de charge, le meuble pourrait devenir instable, s'effondrer, et/ou causer des blessures graves.

AVERTISSEMENT : Risque de blessure corporelle - ne pas placer une télévision sur ce meuble. Ce meuble n'est pas approuvé pour une utilisation avec une télévision.

Page 22

Enregistrez votre produit pour recevoir les éléments suivantes:

- * Détails sur les nouvelles tendances - un aperçu sur les nouveautés
- * Sondages - avoir une voix au sein de notre communauté
- * Offres exclusives et codes promo
- * Service de pièces de rechange rapide et facile

Pour enregistrer votre produit, visitez ameriwoodhome.com

5 Étoiles

Visitez le site Web de votre détaillant local, évaluez le produit que vous avez acheté et laissez-nous vos commentaires !

Nous tenons à offrir un grand "Merci" à tous nos clients pour avoir pris le temps d'assembler ce produit "Ameriwood Home", et de nous donner vos commentaires précieux.

Merci