

BRASILIA ATHENA AWNING

MANUAL AND MOTORIZED MODELS



Installation Manual

2023 VERSION



PLEASE READ ME BEFORE ASSEMBLING

This section contains important warnings concerning your safety and the integrity of your awning.

BEFORE discarding your awning's packaging, we recommend that you take inventory of all the parts as shown in section 1.3.

CAUTION! It is essential to follow these instructions. An improper installation of this product could result in serious personal injury or property damage.

CAUTION! NEVER LEAVE YOUR AWNING OPEN WITHOUT PROPER SUPERVISION.

WARNING: Your awning is not made to withstand strong winds and accumulations of rain, snow or ice. Such buildup could break the awning's arms or cause it to fall, causing personal injury or property damage and rendering its warranty void.

WARNING: The wind sensor is not a security device to prevent damages caused by high winds and rainwater accumulation; accumulated water, snow or ice, can severely damage your awning. A simple power outage will render the automatic closing of the awning impossible.

CAUTION! A proper installation of the supports as well as the integrity of the wall or eaves onto which they will be affixed is the sole responsibility of the customer – user. All houses are different; the anchoring devices supplied with the awning might not be suited for your situation – installation. **WHEN IN DOUBT**, consult a certified contractor.

To help make the installation easier, we are proud to direct you to our website, where you will find a range of technical videos: <https://zonepatio.ca/en/video-tutorials/>.

Please feel free to reach out to us should you have any questions or comments you would like to share by contacting our Customer Service Department at the following number **1-866-466-4182**.

TABLE OF CONTENTS

1 Pre-Installation Checklist

- 1.1 Tools and Resources Needed
- 1.2 Unboxing Your Awning
- 1.3 List of Parts Included
- 1.4 Installation Requirements
 - 1.4.1 Wall Mounted
 - 1.4.2 Under Eaves - Soffit Mounted

2 Wall Mount Installation

- 2.1 Choosing the Mounting Location
- 2.2 Finding the Studs, Joists or Headers
- 2.3 Solidifying with Shims
- 2.4 Installing the Support Brackets

3 Masonry Installation

- 3.1 Choosing the Mounting Location
- 3.2 Where to Anchor on a Brick Wall
- 3.3 Installing the Support Brackets

4 Soffit Mount Installation

- 4.1 Choosing the Mounting Location
- 4.2 Finding the Trusses, Joists or Rafters
- 4.3 Shims and Solidity
- 4.4 Installing the Support Brackets

5 Installing the Awning

- 5.1 Mounting the Awning
- 5.2 How to Test the Stability of the Installation
- 5.3 Connecting and Operating Your Awning
- 5.4 Remote Control and Wall Bracket
- 5.5 Final Adjustments

6 Safety Tips and Advice

- 6.1 Fabric Maintenance
- 6.2 Motor and Remote Control Maintenance
- 6.3 Preparing Your Awning for Winter
- 6.4 Removing the Valance

7 Appendices

- 7.A Adjusting the Pitch
- 7.B Limit Control (Opening and Closing)
- 7.C Motor and Remote Synchronization
- 7.D Wind Sensor
- 7.E Associating a New Remote Control
- 7.F Removing the Awning From its Support Brackets

8 Troubleshooting Guide

1 Pre-Installation Checklist

1.1 Tools and Resources Needed

- Security knife for unpacking, type A or B
- Ladders or stepladders
- Measuring tape
- Carpenter's pencil or ink marker
- Ratchet and socket 9/16"
- Philips screwdriver
- Allen key 6 mm
- Drill
- Level
- 3/16" bit for installation in wood structure
- 3/8" masonry bit for installation in masonry structure



A



B

Optional:

- Stud finder
- Masking tape
- Caulking
- Shims made of nylon, aluminum or copper
- Zip tool to remove siding

Make sure you have helpers to install your awning, we recommend at least 2 people to make sure the installation process. We also recommend that you rent a manual lift or an electrical one such as a Skylift™.

1.2 Unboxing Your Awning

- Your awning will arrive in a long rectangular box tied to a skid. Cut the straps and remove the cover.



- Remove the wooden arches and then cut the green straps. To remove the rest of the packaging, we suggest that you use a security knife as shown in section 1.1.
- Pull the awning out of the box and deposit onto a blanket or grass. You must be at least 2 people to perform this operation safely. Please make sure you have taken all the accessories that were packed in the box, do not throw out your packaging until you have all the items that are listed in section 1.3.
- Once the awning is safely on a blanket or on trestles for easier handling, make sure the crank and the supports are on top. Remove the accessories packed on the awning.
- Carefully remove the plastic wrap, there is a slot on the back of the awning, you can slide the safety knife through. Do not use a regular knife or a self-retracting knife for this could damage the awning. See the photos A and B in section 1.1.

WARNING! The Brasilia Athena's arms are spring-loaded and could open without warning. They have been closed at the factory, but manipulations during transportation could cause them to open abruptly while being unwrapped.

1.3 List of Parts Included

Wrapped onto the Awning

- 1 Hand Crank

Included in the Hardware Box

- 1 Installation Manual
- 1 Remote Control
- 1 Wind Sensor
- 1 Green Plastic Tool to Adjust Motor Limits
- 2 Decorative Plastic Covers

For an Awning Measuring Between 10' to 13'





- 3 Support Brackets (Wall or Soffit)
- 3 Sets of Retainer Hardware
 - 6 Lag Bolts, 3/8" x 4"
 - 6 Masonry Bolts, 3/8" x 4"
 - 6 Washers, 3/8"

For an Awning Measuring Between 14' to 16'

- 4 Support Brackets (Wall or Soffit)
- 4 Sets of Retainer Hardware
 - 8 Lag Bolts, 3/8" x 4"
 - 8 Masonry Bolts, 3/8" x 4"
 - 8 Washers, 3/8"

For an Awning Measuring Between 17' to 20'

- 6 Support Brackets (Wall or Soffit)
- 6 Sets of Retainer Hardware
 - 12 Lag Bolts, 3/8" x 4"
 - 12 Masonry Bolts, 3/8" x 4"
 - 12 Washers, 3/8"

<p>Hand Crank</p>		
<p>Remote Control and Wall Bracket</p>		
<p>Wind Sensor</p>		
<p>Green Plastic Tool to Adjust Motor</p>		
<p>Wall Mount Bracket</p>		

Soffit Mount Bracket	
Decorative Plastic Covers	
Retainer Hardware Sets	
Lag Bolts	
Masonry Bolts	
Washer	

1.4 Installation Requirements

Properly assess the space required to install the awning by following the steps in sections 1.4.1 to 1.4.2 inclusively; this will allow you to determine the type of installation required.

If you have 2 Athena awnings side by side or if your awning is near an inside corner, note that there should be at least 2" spacing between the 2 awnings and 3" on the motor or crank side if it is close to a corner or an interior wall. This will allow you to easily install the decorative caps.

1.4.1. Wall Mounted

NOTICE: No situation is perfect. Some installations (e.g. when there is a gap between the siding and the stud), require a wooden plank or metal support plate to solidify and facilitate the installation of the wall supports. This type of installation requires the consultation of an experienced installer.

Required Height

The slope of your awning is pre-set in our factory to the highest possible pitch, approximately 18" from the top of the bracket, giving the awning a 10' projection. You may need to give your awning more slope if the installation or the surface is not perfectly level. Take this into consideration when choosing the installation height.

The minimum installation height is 96", but we recommend an installation height 108". It is also necessary to have a 9 ½" free zone in height over the total width of the awning (above its structure).



If your awning is motorized, it must be plugged into a GFI electrical outlet. The motor's electrical cord is 15' long. The motor's amperage requirement is fewer than 2 amps (2A).

Required Width

The number of supports for an Athena awning varies depending on the width of the awning in question. The weight of the awning is solely supported at the anchoring points. Therefore, studs or other structural parts of the house are mandatory at these anchor points.

Whether you are installing on siding, masonry or other types of wall, note that the far corner of the wall has a few inches without structural studs, this is regardless of the type of exterior cladding. Consider this if you have limited space to install the supports if your installation is on a narrow wall or if there are windows close to the corners.

You will need to find the studs or joists to install the supports. It should be noted that many recent constructions have composite « I » joists or open joists instead of solid wood joists. **These types of joists cannot be used to anchor the awning.**

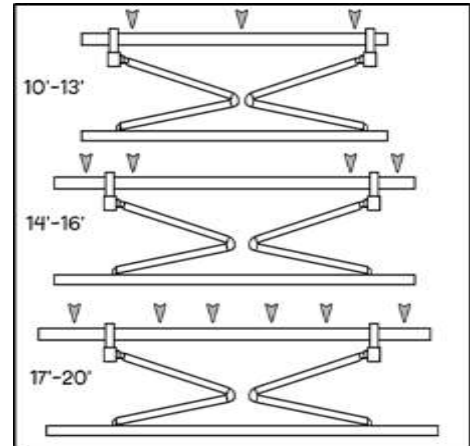

Masonry

Masonry walls are weaker near the top. A minimum of 20" or 4 to 6 rows of brick above the installation area is needed for a secure support installation. Make sure the brick and mortar are in sound condition to ensure a safer and easier installation. The weight of the bricks above the supports will prevent the weight of the awning from dismantling the bricks.

WARNING! Some brick walls might not be strong enough to safely support an awning. The supplied fasteners are not designed to attach the awning to these types of bricks: veneer, decorative or soft bricks.

WHEN IN DOUBT, consult a certified contractor to confirm if the supplied fasteners are adequate for the type of wall onto which you are planning your installation. If they are not, he will be able to inform you on your installation's specific requirements.

1.4.2 Under Eaves - Soffit Mounted

You need to open your soffit to see inside your eaves and plan before you can even consider a soffit mount for your awning. You need to see if your joists or rafters are levelled or slanted and if they are in good condition and are strong enough to support the awning.

If your trusses are slanted, you will need to purchase adaptors for rafters or you will need to install a levelled beam; please consult a certified contractor on this subject if this is the case for your type of installation.

Please note that levelled beams and rafter adaptors are not included in the price of your awning.

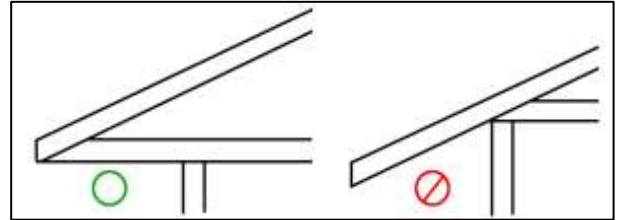

If your eaves are cantilevered on both sides, the corners of the eaves are not strong enough to support the awning.

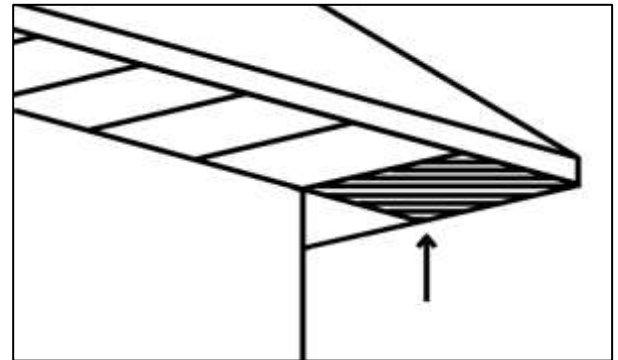

This means that your awning cannot be wider than the wall, even if the eaves are wider than the wall and you had planned the installation under eaves.

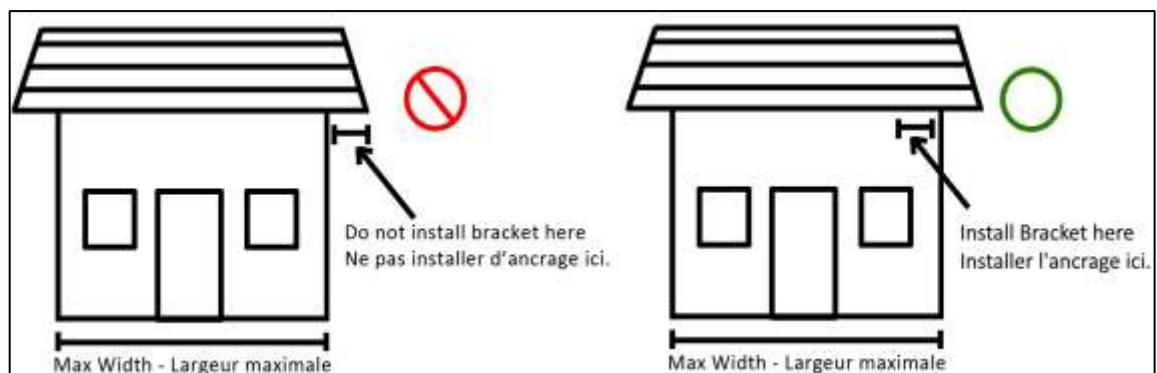

2 WALL MOUNT INSTALLATION

In this section, we will be examining the installation procedure. Installation of the brackets can be done by one person, but you will need at least one other person to install the awning onto its supports. The installation of the supports is the crucial part of the process, it requires the most time and attention to detail.

For all buildings with an internal wooden structure and wood, vinyl or aluminum siding, the lag bolts must be firmly anchored into a structural part of the building. Make sure to find the centre of the structural piece and pre-drill before fixing the lag screw.

2.1 Choosing the Mounting Location

Installation Height

- Be sure to leave at least 9 ½” between the top of the supports and the bottom of the eaves, as shown in the figure below.
- The slope of your awning is pre-set at the factory to the highest possible position, which is approximately 18” from the top of the wall support.
- For example, if you are installing the awning on a wall at a height of 9’ from the deck or patio, the clearance height of the front bar of the awning will be 7’ 6” when the awning is fully open .

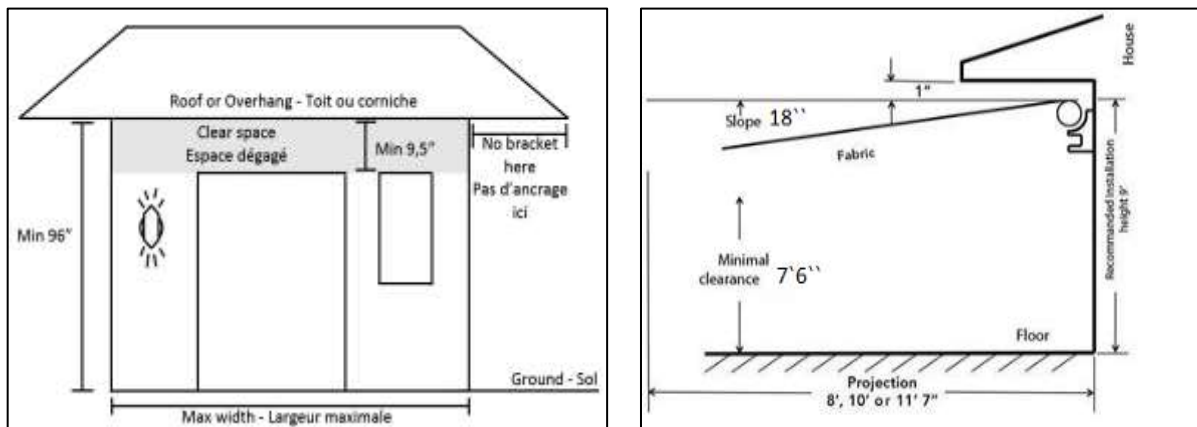

- If needed, the pitch can be readjusted, see Appendix **7.A**. You can also watch our video tutorial on pitch adjustment at: <https://zonepatio.ca/en/video-tutorials/>.
- Measure up from the deck/patio floor on one side and make a mark at your desired mounting height less 1”. Do the same on the right side.
- Make a second mark 9 ½” below the first mark. The space between these two marks must be clear of any obstacles along the wall (light fixtures, etc.).
- Trace a line on the lower mark for the full length of the awning. The bottom of the wall support will rest on the lower line.

- If you decide to install a soffit support on the wall, the top of the soffit support can touch the eaves.

Installation Width

- Measure the awning to verify its width. On the wall, make vertical markings at the centre and at both ends of the awning.
- Then draw the horizontal limits of the installation area, keeping a space of 9 ½” between the 2 lines. The installation area of your awning has now been defined.



- Refer to the diagram below to choose the appropriate position of the supports, depending on the length of the awning you purchased.

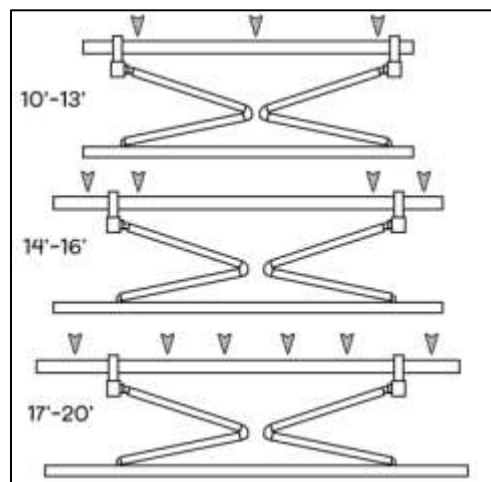

2.2 Finding the Studs, Joists or Headers

You now need to find the studs, joists or headers in the area in which each screw must be anchored and similarly to where the holes of the brackets must be drilled.

WARNING! You should never install wall supports opposite the arm supports. Instead, they should be installed on each side, favouring the inside of the arm supports.

Method A

If you plan to install your awning on a wall with a window or door, you can use this opportunity to locate the studs inside your home and transfer those measurements to the outside wall.

- You will need some masking tape. From the inside of your house, on the wall where the awning will be installed, place a strip of 6" of masking tape vertically on the glass of your patio door or the windowpane.
- Now locate the studs on the same interior wall and mark the centre of each stud. Depending on the type of siding you have, you can use a stud finder.
- Measure from the piece of masking tape or the patio door to the centre of the stud and record the measurements with a pencil mark.
- Continue to find the additional studs and mark the measurements.
- From the outside, using the measurements taken on the inside, locate the studs by referring to the measurements from the tape strips.
- Mark the centre of each stud where a screw will be attached to the support with a 6 ½" vertical line.
- To facilitate mounting the awning onto the support brackets, make sure that the line is straight and levelled.

NOTE: Shims may be required.

CAUTION! Proper installation of the supports is the most important and critical step in the awning's installation. It is imperative that all screws are securely fastened to studs, joists, planks or other major structural elements. Failure to do so could cause the awning to collapse and cause bodily injuries as well as material damages.

Even a moderate wind can exert a great force on the awning and its support brackets. This is why we emphasize that the brackets are securely fastened.

Method B:

Use this option if **Method A** doesn't work:

- Lift the clapboard (with a siding hook) and locate the studs in the furring strip.
- Test by pushing a nail, screw or drilling a small hole to locate the studs. Keep in mind that the furring strip is rarely centred with the studs (structural part of the house).
- While measuring, you may notice that the wall is curved. In this case, it will be necessary to put more shims for some supports than others. It is imperative that all supports be aligned in depth (projection) as well as in height.
- Decide if the shims should go on top, under or through the siding. If the shim goes on top of the siding, it is important that it is resting against a solid surface. The shim or shims should NEVER rest on fibreboard (Tentest), insulating foam or mineral wool.
- If there is sheet insulation, fibreboard or mineral wool in between the support location and solid surface, remove a square of the insulation material and replace it with a piece of solid wood on top of the solid surface. That piece of wood needs to be well anchored and will serve to support the shim or the support.

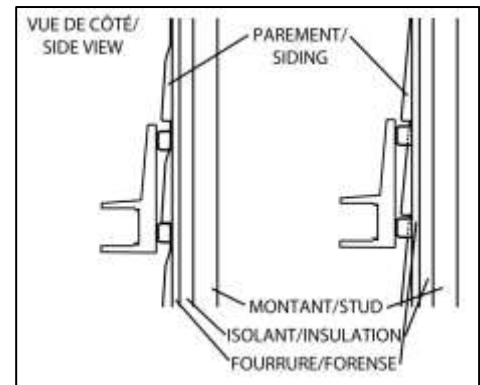

WARNING! There are often furring strips on top of the fibreboard, wider than the stud. The lag bolt must be installed in the stud, not just in the piece of wood and not just in the furring strip. Probe the chosen spot with a small drill bit before installing, to avoid shattering the stud by drilling too close to its edge.

NOTE: Shims may be required depending on the type of siding.

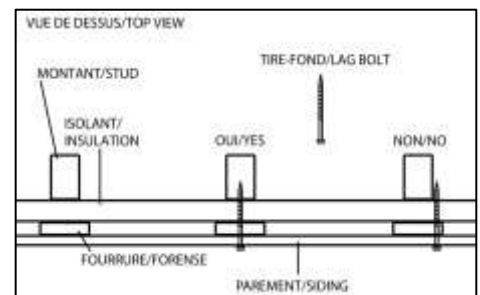

2.3 Solidifying With Shims

Sidings, corrugated metal, stucco, decorative bricks and wood often have a void between the structural elements and the siding. If the awning crushes the siding, the latter can move. If the awning moves, this will result in an uneven installation, which can cause the awning to fall and cause physical and material damages.

In order to have a solid installation, use the appropriate shims. A good way to shim the supports is to use tubular shims or nylon, aluminum, copper or other (no iron or steel).

The shims can be installed on top of the siding if a sufficiently large surface is in direct contact against a solid surface. Otherwise, the shims can be installed underneath the siding where a hole can be cut into the siding for the shim to be inserted.

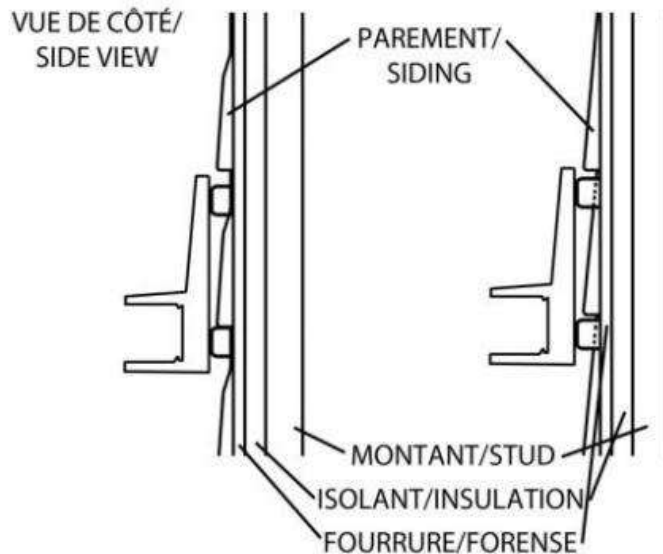

WHEN IN DOUBT, consult a certified contractor to confirm if this type of mounting is suitable.

WARNING! It is mandatory to put caulking around the shims or spacers to prevent water infiltration.

2.4 Installing the Support Brackets

Once the studs, joists or headers have been found and the appropriate length shims have been chosen you are ready to install your support brackets.

- Make sure that every single bracket needed is installed exactly in the middle of each stud.
- Use a 3/16" drill bit to drill 3" deep holes throughout the siding and the shims into the studs or joists. Doing so will help to prevent the studs from splitting or eroding while doing the installation of the lag bolt.
- Using a 9/16" socket, install the supports using 3/8" X 4" lag bolts.
- Use the supplied washer between the screw heads and the supports.
- While tightening the lag bolts, keep the support level using a level. Do not overtighten the lag bolts; this could split the wood structure or weaken the screw's retaining force.

3 MASONRY INSTALLATION

WARNING! Some masonry walls may not be designed to support an awning safely. The fasteners provided are not designed to secure an awning to certain types of brickwork (or decorative brickwork, hollow concrete block or stucco). If this is the case, please consult a certified contractor to confirm if this type of mounting is adequate. Some constructions may require more screws, which are not included with your awning.

You will need to install shims if the brick surface is uneven.

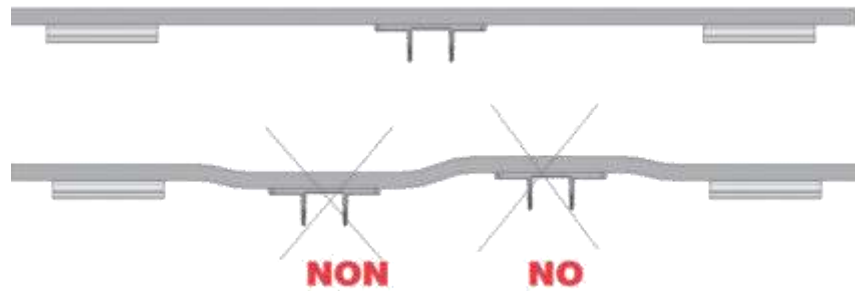

3.1 Choosing the Mounting Location

Make sure to leave at least 9 ½” between the bottom of the supports and the eaves. The awning is higher than the support.

WARNING! Never install the supports on the 4 to 6 rows of bricks or the first 20” located at the top of the wall, near the roof. These rows of bricks cannot support the weight of your awning.

3.2 Where to Anchor on a Brick Wall

- Based on the awning size chart, choose the correct position to install the support brackets. It is more important to ensure a secure bracket installation than to follow exactly the position on the chart.
- Make sure that all the bolts are inserted at least 1” from the brick’s edge and that the supports do not interfere with the arm’s position.
- Place each bracket at the right height, using the bottom chalk line and trace every bracket and every hole position while making sure that the brackets are levelled

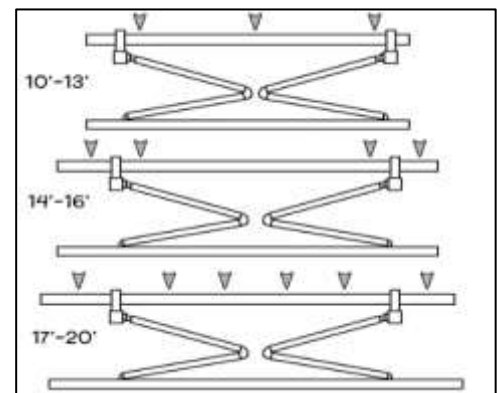

ATTENTION! The masonry hardware supplied with the awning is not designed to use in joints between 2 bricks. It must be installed in the middle of the brick, at least 1" from the exterior edges of the brick.

The fasteners are also not designed for hollow surfaces. Visit a hardware store for proper fasteners that must be used for your type of installation.

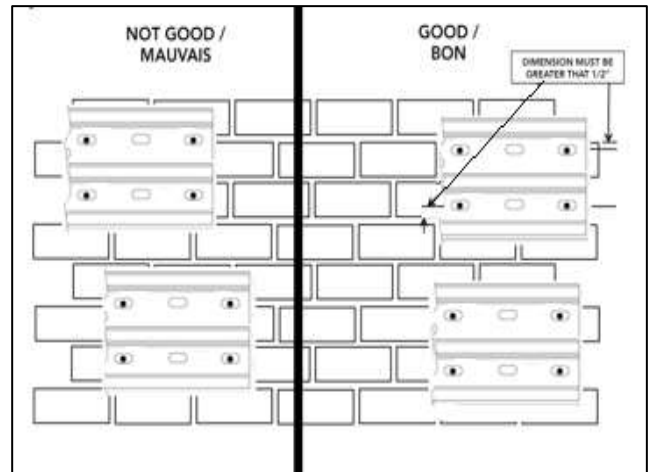

3.3 Installing the Support Brackets

WARNING! The holes must be drilled in two distinct steps. Otherwise, you risk drilling the holes too big or too small and the brackets will not be securely fastened to the wall.

- Place the first support at the required height referring to the chalk line at the bottom, making sure that it is levelled.
- Locate the brick joints and mark the spot where the screws will hold the support making sure to respect the minimum distance between the edge of the brick and the support holes.
- Repeat the same operation for the other supports. First, use a 1/8" masonry drill bit to drill 3" deep holes through the masonry or bricks.
- Then, use a 3/8" masonry drill bit to drill 3" deep holes into the masonry or concrete wall.
- Make sure to keep the drill bit as steady as possible to ensure the holes do not become conic or flared, see figure opposite.
- With a 9/16" socket, fit the 2 supports starting with the top 2 holes using a 3/8" x 4" masonry screws.
- Use the washer provided beneath the head of the screw.
- Tighten the masonry bolts but keep the support level by using a level. Do not overtighten the masonry bolts, as this may crack the concrete structure or weaken the bolt's holding power.
- Apply caulking all around the bracket to prevent water infiltration.

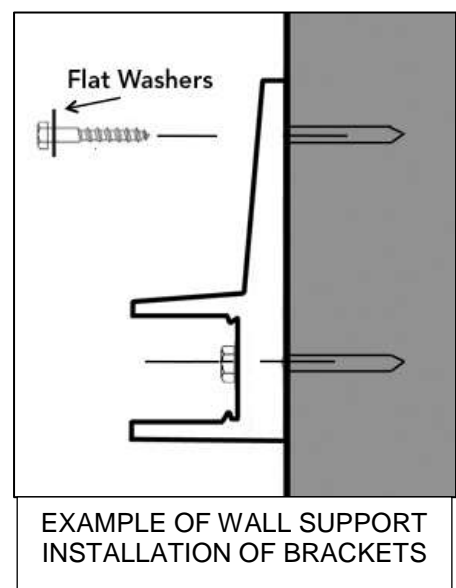

WARNING! You must make sure that masonry bolts are securely fastened into holes. Otherwise, remove them and consult a hardware store for appropriate masonry bolts.

4 SOFFIT MOUNT INSTALLATION

It is imperative to properly gauge the distance between roof joists or rafters and the soffit or other decorative fascia, in order to choose an appropriate wedge. It is usually easier to find a structural support near the edge of the eaves than near the wall.

The following instructions are for installations that are perfectly horizontal and level under soffit or fascia. On some installations under soffit or angled trusses, a truss support (make sure it is long enough for your needs) or angled shims may be required.



Truss adaptors may be required for soffit installation. If needed, please contact us at 1-866-441-4182 or sac@auentsmultiples.com

4.1 Choosing the Mounting Location

- Draw a straight horizontal line under the cornice, longer than the length of the awning. This line represents the back of the support. The support has a depth of 3.22”.
- When drawing a line under the cornice, keep in mind that once the awning is retracted, it will still be 10” deep.

NOTE: Even a moderate wind exerts a great force on the awning and supports. This is why it is very important that all brackets are fixed correctly and securely.

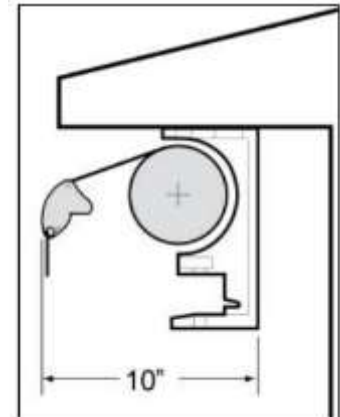

WARNING! Proper positioning of the cornice supports is the most important and critical step in erecting the awning. It is imperative that all screws are well anchored to the rafters or other major structural elements.

4.2 Finding the Trusses, Joists or Rafters

- To find the rafters, use a stud finder if possible. It is likely that you will have to remove part of the soffit or the decorative covering of your cornice. Mark the centre of each rafter where a support is to be installed with a 6" line.
- Using the brackets and chalk lines, choose the final location for the awning. Make sure that each of the necessary screws is positioned in the centre of a rafter.
- Referring to the diagram, determine the position on the rafters. It is more important to ensure a good support than to follow exactly the placement of the diagram.

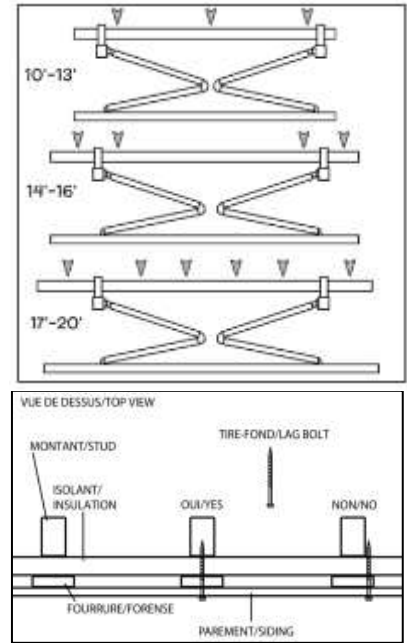

4.3 Shims and Solidity

Sometimes, there is a good distance between the soffit or other decorative facing and the rafters and roof trusses. In order to have a solid installation, use the appropriate shims.

A good way to shim the supports is to use tubular shims or nylon, aluminum, copper or other (no iron or steel) washers. If the distance between the rafters and the soffit or decorative facing is too great, you will need to install a beam of the thickness needed by the total length of the awning (thickness needed X length of the awning) or a combination of beams and shims. Make sure your shims are sturdy. The greater the distance, the more the shims are likely to move if they are narrow.

4.4. Installing the Support Brackets

- Use a 3/16" drill bit to drill all holes approximately 3 1/2" deep in the rafter. This will help prevent spalling or splitting of the rafters when installing the lag bolts.
- Using a 9/16" socket, install the brackets, making sure they are level, with the 3/8" x 4" lag bolts.
- Use the washer provided under the head of the screw.
- While tightening the lag bolts, keep the bracket level. Do not overtighten the lag bolts; this could split the wood structure or weaken the screw holding force.
- If necessary, use shims.

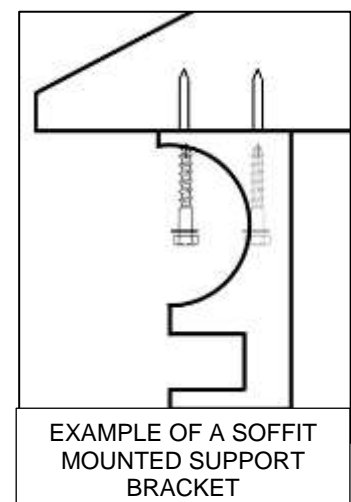

ATTENTION! You must securely fasten all the screws to the rafters. Some constructions may require more lag bolts. **WHEN IN DOUBT**, consult a certified contractor. The improper installation could cause the awning to collapse and cause injury and property damage.

5 INSTALLING THE AWNING

5.1 Mounting the Awning

- Carefully remove all packing material from the awning.
- With the help of at least one other person, lift the awning (with the front bar facing you and the roller behind). Even a small awning weighs more than 50 kg.
- Slide the bar into the brackets and secure it by tightening the mounting hardware for each bracket.
- Be sure to insert the mounting screw and shim from the bottom of the bracket upwards; the fixing screw must pass through the wedge through the hole provided for this purpose.

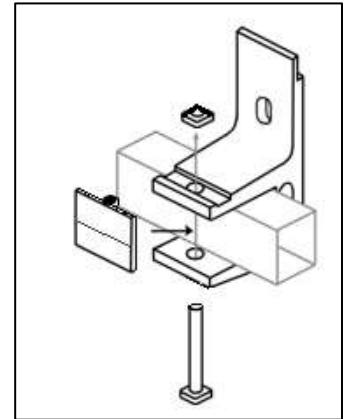

5.2 How to Test the Stability of the Installation

In order to test the strength of your awning, you will need help.

- Open it completely.
- One person must stand near the wall. The other person should stand at the end of the unrolled fabric and gently lift the front bar of the awning and move it. A properly installed and secure awning will have its arms move a little, but the housing and brackets should not move.
- If the awning moves, this indicates 2 possible problems:
 1. The fixing screws are not screwed into the studs; if so, you need to locate the studs, beams, or floor joists in the area where each screw should be anchored. Depending on the installation you have done, consult the appropriate support installation sections: **2.4**, **3.3** or **4.4**;
 2. The surface is uneven; use appropriate shims. A good way to shim supports is to use tubular shims or nylon, aluminum, copper or other washers (not iron nor steel). Depending on the installation you have done, see the appropriate shims and strength sections: **2.3** or **4.3**.

5.3 Connecting and Operating Your Awning

Plug the electrical cord into a GFI electrical outlet.

With the remote control, command the complete opening of your awning. You can then finish unpacking the awning arms.

NOTE: During a power outage, you can open or close your awning using the crank provided. Simply unplug the awning, insert the crank through the w” loop and spin. You may need to adjust the opening limits of your awning after using the crank without first unplugging the motor, see Appendix **7.B**.

5.4 Remote Control and Wall Bracket

Please note that the remote control should not be left outside, it could be exposed to water, and this could affect its proper functioning. We recommend that you install the wall bracket for the remote control inside the house.



How to replace the batteries in your remote control:

Note that you may need to replace the remote control battery after 3 years or sooner if it stops working.

- Test the remote control by holding down one of the buttons. The LED indicator should flash for at least 5 seconds. If not, you should replace the battery immediately.
- You should be able to find this type of lithium battery (3 volts, CR2430) at any hardware or electronics store.
- Unplug the awning.

- To replace the battery, use a pointy object (paper clip) to press on the little hole, as indicated in this diagram. Then simply push on the battery cover and slide it off.
- Remove the back cover, note the orientation of the battery when removing it; this will tell you the polarity, replace the old battery while respecting the polarity.
- Slide the back cover into place, and re-plug your awning.



5.5 Final Adjustments

The motor open and close stop limits have been programmed and tested at the factory. If you need to change the motor open and close limits, see Appendix 7.B.

CAUTION! If you are using the crank or making adjustments to your awning, do not allow the awning to open beyond the point where the canvas could sag or roll up the wrong way inside the housing. This could damage the fabric.

- Test your awning using the “▲” and “▼” buttons on your remote control.
- If your awning does not open to its full projection or does not appear to open and close properly, follow the instructions in Appendix 7.B to change the opening and closing limits.
- Please go to our website to watch the video, [zonepatio.ca/video-tutorials/Programming the opening and closing limits](https://zonepatio.ca/video-tutorials/Programming-the-opening-and-closing-limits)

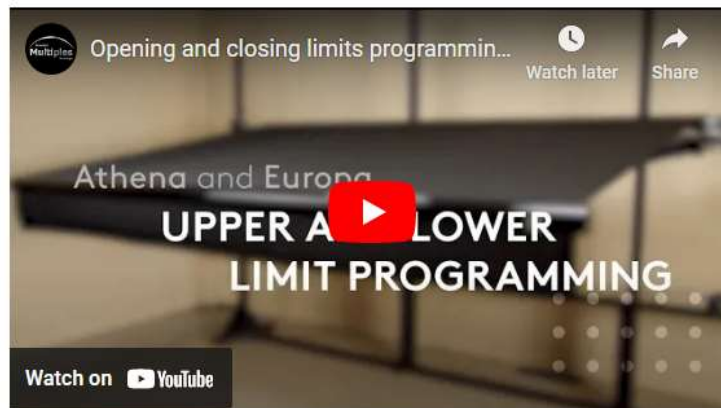
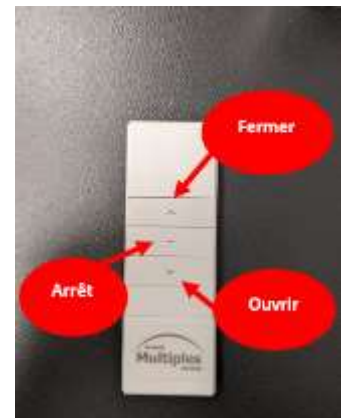

6 SAFETY TIPS AND ADVICE

- **CAUTION!** Before using the awning, make sure that there are no objects or people obstructing its path when opening and closing it. Keep children away from all moving parts to avoid bodily harm.
- **CAUTION!** Items should never be hung from different parts of the awning, like flower pots off the arms, except for the accessories supplied by the manufacturer.
- **CAUTION!** Never attempt to repair or disassemble awning parts without following the procedures provided by the replacement parts manufacturer. Attempting to make repairs without proper instructions may cause personal injury and awning malfunction, and may void your warranty.
- **WARNING:** Damage to the fabric, arms and mechanisms caused by accumulation of water, rain, snow, ice or strong winds is not covered by the manufacturer's warranty. You should always retract your awning during periods of snow, ice, rain or strong winds. Never leave an open awning unattended.
- **CAUTION!** The accumulation of water, rain, snow or ice can cause damage or collapse of the awning and/or personal injury. You should retract your awning when water begins to pool on the fabric. Water will drain when retracting the awning. Be sure to reopen your awning to dry the canvas when possible.
- **CAUTION!** Never use a barbecue or any type of patio heater or fireplace under your awning. The use of this type of heat emitting unit could melt or burn the fabric, even worst it could ignite and cause serious damages.
- **WARNING:** During long-term storage or non-use of a motorized awning, the manufacturer suggests running the motor every few months to maintain the lubrication of the internal components.

6.1 Fabric Maintenance

Our acrylic fabrics are woven with 100% solution-dyed fibre and are coated with a special protection, which delays the formation and accumulation of dirt. In order to properly preserve the fabric, its cleaning must respect the following instructions:

- Carefully remove dust from dry awning fabric by vacuuming, or gently brushing. **NEVER USE A PRESSURE WASHER**, as this will strip the water-repellent coating and damage the seams.
- Brush lightly with a mixture of lukewarm water and mild organic soap. We advise you to use Aqua-Tek's product, Easy Clean™. This product is made in Canada, it is eco-friendly and available in our showroom. Contact our Customer Service for more information: 1-866-446-4182.
- Rinse thoroughly to remove all traces of soap.

ATTENTION! If an awning is retracted while the fabric is still wet, open the awning as soon as possible to allow the fabric to dry. Although the fabric is treated against mildew, it is necessary to do this because the deposits of atmospheric pollution on the surface of the canvas are likely to develop mould in these humid conditions.

6.2 Motor and Remote Control Maintenance

The electric motor is equipped with an automatic shutdown system in the event of overheating. If you open and close your awning several times in succession, the motor will automatically stop before it overheats. The motor resumes normal operation after 20 minutes of cooling.

Protection of the GFI electrical outlet against water infiltration:

To prevent water from entering the GFI wall outlet, it is recommended that you form a drip loop at the end of the power supply cord. It is also recommended to install a protective cover. These covers are available at most hardware stores.

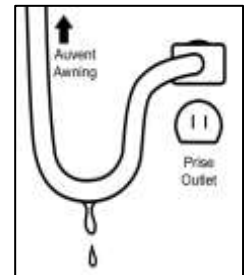

6.3 Preparing Your Awning for Winter

Unplug the power supply cord from the GFI outlet and cover the outlet to prevent rain and moisture from entering. Water and moisture could interfere with the proper functioning of the plug and motor in the spring.

Before retracting your awning for the last time of the season, make sure the canvas is clean and dry to prevent mould from forming during the winter. Then remove the valence, see section 6.4.

Remember to remove the batteries from the remote control and the wind sensor.

6.4 Removing the Valance

1. Remove the three screws located at the end of the front bar.
2. Remove the cap from the front bar.
3. Drag the valence out of the channel.
4. Screw the cap back on with the appropriate screws.

Please visit our website to watch the video on the subject:

[Zonepatio.ca/video-tutorials/Valance Replacement or Removal – Athena and Europa](https://zonepatio.ca/video-tutorials/Valance-Removal-or-Replacement-Athena-and-Europa)

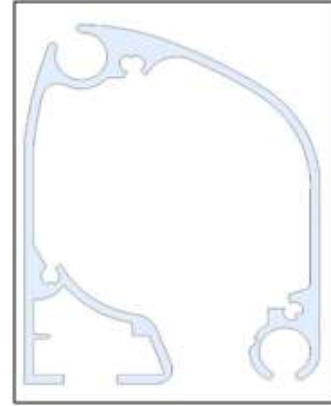

CAUTION! If you have a sun curtain attached to the front bar, it will be easier for you to remove the cap on the opposite side of where your winch is located (hand crank).

7 APPENDICES

7.A ADJUSTING THE PITCH

Fully open the awning using your hand crank or remote control. If your awning is motorized, open the awning and then unplug the power cord from the outlet.

WARNING! Reducing the slope of the awning may increase the accumulation of water on the fabric. To prevent the awning from collapsing due to rainwater accumulation, you should always retract your awning when it is unattended. Failure to follow this recommendation could result in bodily injury, property damage and void your warranty.

NOTE: Depending on awning size and model, front bar weight will vary (wider awnings have heavier front bars). The weight will therefore have an effect on the height to which you can raise the front bar, depending on the adjustment capabilities of the arms. If you reach the maximum level of adjustment and are still not satisfied with the height of the front bar, you can always mount the awning by adding shims under the bottom of the brackets to tilt it towards the wall.

1. Remove the protective plastic cap from the arm support, just pull on it gently. This will show you if your awning is close to its upper or lower limit.
2. Ask your assistant to raise the front bar several feet above the desired height. There are two screws under the arm support. The one closer to the house prevents the front bar from rising and the one further from the house prevents the bar from falling.
3. Once you have adjusted the first arm to the desired height, adjust the other arm in the same way.
4. Make sure the front bar is levelled.
5. Replace the plastic cap.

6. If you purchased a motorized awning, plug the power cord into the GFI electrical outlet and enjoy your awning.

TO DECREASE THE SLOPE (PITCH) OF YOUR AWNING

- Use an Allen key of 5 mm to lower the screw located furthest from the wall, diagram **A**, then raise the screw located closest to the wall, diagram **B**.



TO INCREASE THE SLOPE (PITCH) OF YOUR AWNING

- Use an Allen key of 5 mm to lower the screw that is located closer to the wall, diagram **A**, then use the Allen key to raise the screw that is located furthest from the wall, diagram **B**.



- Ask your assistant to release the front bar to check if it has reached the desired height.

Please visit our website to watch the video about it:
[Zonepatio.ca/video-tutorials/Pitch Adjustment-Athena and Europa](https://zonepatio.ca/video-tutorials/Pitch-Adjustment-Athena-and-Europa)

7.B LIMIT CONTROL – OPENING (LOWER) AND CLOSING (UPPER) LIMITS

You will need the green plastic adjustment tool included with your awning.



CAUTION! You must leave the green screwdriver in the screw throughout the procedure. If you remove the screwdriver before the end of the procedure, you will have to start over from the beginning.



OPENING LIMIT FOR AWNINGS WITH THE MOTOR ON THE RIGHT

- Make sure your awning is plugged into your GFI outlet.
- The endless screw that is closest to the wall controls the opening limit, there is a (-) and a (+) that is indicated under the endless screw to change the opening limit of your awning.
- Press the lower button on the remote control to open your awning, while opening, if the motor is on the right side, turn the endless screw that is closest to the wall towards the negative (-) until it stops moving.
- Then turn the endless screw towards the positive (+) until the fabric reaches the desired limit. If you have exceeded the desired limit, just turn the endless screw towards the (-).

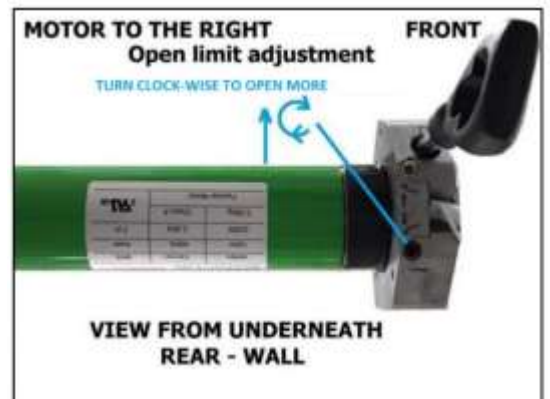

- Once you have reached the desired position, press on the middle button on the remote control and remove the green screwdriver.

OPENING LIMIT FOR AWNINGS WITH THE MOTOR ON THE LEFT

- Make sure your awning is plugged into your GFI outlet.
- The endless screw that is furthest from the wall controls the opening limit, there is a (-) and a (+) indicated under the auger to change the opening limit of your awning.

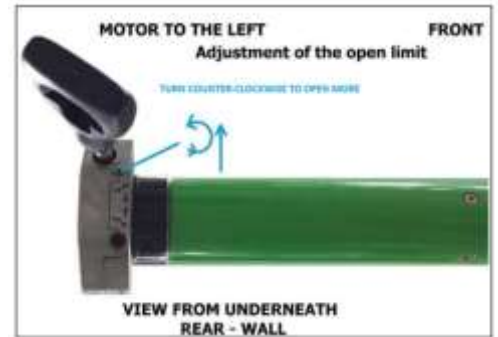

- Press the lower button on the remote control to open your awning, while opening, if the motor is on the left side, turn the endless screw furthest from the wall towards the negative (-) until the movement stops
- Then turn the endless screw towards the (+) until you have reached the desired limit. If you have exceeded the desired limit, turn the endless screw in the opposite direction towards the (-).
- Once you have reached the desired position, press on the middle button on the remote control and remove the green screwdriver.

NOTE: The fabric should roll up above the roll, not below. If the fabric rolls up from the underside of the roller, keep your finger on the “▼” arrow and unroll it all the way, this will activate the rolling on the opposite side. Then roll up the fabric until both arms are securely locked and the fabric is taut.

CLOSING LIMIT FOR AWNINGS WITH THE MOTOR ON THE RIGHT

- Make sure your awning is plugged into your GFI outlet.
- The endless screw, which is the furthest from the wall controls the closing limit.
- While you close your awning, if the motor is still running after the awning is closed, stop it by pressing the stop button on your remote.
- From a partially open position of your awning, press the up button on your remote control to close the awning.



- While closing, if the motor is on the right side, turn the endless screw furthest from the wall towards the negative (-). Keep turning the screw until the awning stops moving.
- Next, turn the endless screw which is furthest from the wall towards the positive (+) until you reach the desired closing limit, then pull out the green adjusting tool and press the middle button on the remote control.

CLOSING LIMIT FOR AWNINGS WITH THE MOTOR ON THE LEFT

- Make sure your awning is plugged into your GFI outlet.
- The endless screw that is the closest to the wall controls the closing limit.
- While you close your awning, if the motor is still running after the awning is closed, stop it by pressing the stop button on your remote.



- From a partially open position of your awning, press the up button on your remote control to close the awning.
- While closing, if the motor is on the left side, turn the endless screw closest to the wall towards the negative (-). Keep turning the screw until the awning stops moving.
- Next, turn the endless screw closest to the wall towards the positive (-). When you have reached the desired closing limit, pull out the green adjusting tool and press the middle button on the remote control.
- **NOTE:** The fabric must roll up above the roller and not below. If the fabric rolls up from the underside of the roller, keep your finger on the “▼” arrow and unroll it all the way, this will activate the rolling on the opposite side. Then roll up the sling until both arms are securely locked and the sling is taut.

Please visit our website to watch the video about it:

[Zonepatio.ca/tutorials-videos/Programming the Opening and Closing Limits](https://zonepatio.ca/tutorials-videos/Programming%20the%20Opening%20and%20Closing%20Limits).

7.C MOTOR AND REMOTE SYNCHRONIZATION

NOTE: This procedure describes the steps required to re-establish communication between the motor and the remote control supplied with your motorized awning or to reprogram a new remote control if you have lost the one supplied with your awning.

This procedure should be performed only if the remote control does not operate the motorized awning. Carefully review the steps below to familiarize yourself with the procedure before attempting to complete it.

1. Check that the blue light on the remote is on when you press a button. If the blue light does not come on at all or flashes for less than five seconds, you will need to replace the battery, see Section 5.4.
2. Unplug the electrical cord from the outlet for 10 seconds.
3. Using a paper clip, press on the small hole on the back plate of the remote control and simultaneously slide the cover off, find the « P2 » button which is on the left at the back of the remote control.



4. Reconnect the electrical cord.
5. **CAUTION!** You have 10 seconds to make the following steps. Respect an interval of 2 seconds between each action on the remote control, otherwise the motor will not retain the new parameters.



6. If the motor is on the left, press the "P2" button 2 times, then on the up arrow "▲". The motor will move, indicating that it has memorized the new remote.
6. If the motor is on the right, press the "P2" button 2 times, then the down arrow "▼". The motor will move, indicating that it has memorized the new remote.
7. Press the up arrow "▲", the awning should then close. If it opens, repeat the steps for memorizing the remote control and press the down arrow "▼".

If the awning still does not close, unplug the motor again, wait 10 seconds and plug it back in. Then press the down arrow "▼".

Since you have a new remote control, you will eventually need to reprogram the wind sensor. See Section 7.D.

Please visit our website to watch a step-by-step video: [Zonepatio.ca/video-tutorials/Remote Control Programming](https://Zonepatio.ca/video-tutorials/Remote-Control-Programming)

7.D WIND SENSOR

The wind sensor is not considered a safety device that eliminates breakage related to wind or the accumulation of water, snow or ice. In fact, a simple power failure makes it impossible to automatically close the awning.

NOTE: Please note that the manufacturer assumes no responsibility for personal injury or property damage that may occur due to weather phenomena not detected by the sensors of the device.

The wind sensor is equipped with an integrated and autonomous radio transmitter. It works by detecting, in real time, the force generated by the wind. When the detected value exceeds the programmed limit, the detector sends a radio signal to the motor receiver which in turn issues a command that closes your awning.

INSTALLATION OF THE WIND SENSOR

CAUTION! Always make sure to unplug the awning when an action must be made on the front bar of the awning. The wind sensor could cause the awning to close and this could cause you to fall.

1. Open the wind sensor by pushing the cover in the direction of the arrow, the cover will move slightly, and then you can remove the cover.

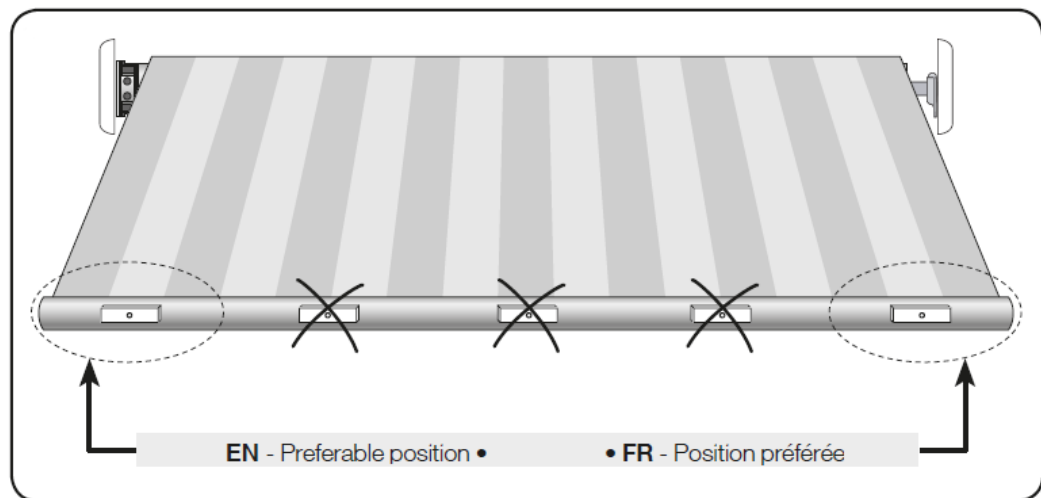

NOTE: Prior to October 1st, 2022, the wind sensor back plate was affixed to the front bar with a strip of double-sided tape. Since then, we have decided to screw the back plate into the front bar to ensure it doesn't fall off.

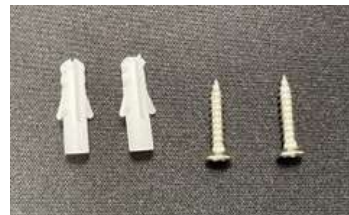

2. Follow the steps in Appendix **7.D**, sections: How to program the wind sensor and how to calibrate the wind sensor.

NOTE: If the wind sensor causes the awning to close due to strong winds, it can only be opened again after a 10-minute time-out.

HOW TO ACTIVATE A NEW WIND SENSOR

The wind sensor is supplied with a base calibration of 4, this is programmed at the factory. The Dooya wind sensor must be memorized by the motor receiver as it must be done for all remote controls, here are the steps:

1. Slide the cover off the wind sensor by pushing it towards the arrow. Remove the black casing and insert the battery. The wind sensor will beep once to let you know it is functional.
2. Using a remote control that has already been memorized by the motor, remove the back cover and press on the **P2** button on the left, twice.



3. Press on the multifunctional button of the new wind sensor once, the wind sensor will beep once to let you know it has been synchronized with the motor of the awning.
4. Place the front of the wind sensor on the back plate and slide in the opposite direction of the arrow to secure it back on.

HOW TO PROGRAM A NEW WIND SENSOR

NOTE: This procedure is to be done on a new wind sensor if you had to replace the original wind sensor that came with your awning.

1. Make sure your awning is plugged into the electrical outlet.
2. Slide the cover off the wind sensor by pushing it towards the arrow.



3. Remove the black casing and find the sensitivity dial, set it to 0. Then insert the battery and the wind sensor will beep once to let you know it is functional.
4. Using a remote that has already been paired with the motor, press twice on the button « P2 » on the **left**, located on the back of the remote.



5. Press on the multifunctional button of the new wind sensor once, it will beep once to let you know that it has been paired with the motor.
6. Set the sensitivity button to 5, which is the mid sensitivity position, and then press the multifunctional button once; the awning will close completely.
7. Set the sensor's sensitivity to 9 and press on the multifunctional button once; the awning will open completely.
8. Set the sensor's sensitivity level to 4, the wind sensor is now programmed and paired with the motor and the remote.
9. Place the cover of the wind sensor onto the base and simply slide in the opposite direction of the arrow to secure it to the base.

CALIBRATING THE WIND SENSOR

The wind sensor is programmed in our factory. After installation, you must check to see if the basic calibration is right for your awning or if it is necessary to readjust the sensitivity according to the weather conditions where you live.

The Dooya Wind Sensor has 9 sensitivity levels available on the sensitivity switch. A small flat screwdriver is required to change the sensitivity. One (1) is the most sensitive position while 9 is the least sensitive position, 0 has no sensitivity.

To see if your wind sensor must be readjusted, you can test the sensitivity in the following way:

1. Open your awning completely.
2. Shake the front bar of the awning manually to make it vibrate, imitating a strong gust of wind.

3. If the wind sensor closes the awning then you have the correct level of sensitivity, if not, you will have to adjust the sensitivity level. To do so, take a small screwdriver and turn the dial to the level needed.
4. Repeat this test by shaking the front bar, as in step 2, and adjust the level if needed.

NOTE: After the wind sensor has closed the awning, you will need to wait 10 minutes before you are able to open it again with your remote control.

Please visit our website to watch a step-by-step video: [Zonepatio.ca/video-tutorials/Wind Sensor Programming](https://zonepatio.ca/video-tutorials/Wind-Sensor-Programming)

7.E ASSOCIATING A NEW REMOTE CONTROL

This procedure applies if you have lost your new remote control and need to have it associated to the motor.

1. Unplug the awning.
2. Using a paper clip, press on the small hole and simultaneously slide the cover off, make sure the battery is properly installed, locate the "P2" button on the back of the remote control.
3. Plug in your awning, **CAUTION!** You have 10 seconds to make the next step.
4. If the motor is on the left, press the left "P2" button 2 times, then the up arrow "▲". The motor will move, indicating that it has memorized the new remote.
5. If the motor is on the right, press the left "P2" button 2 times, then the down arrow "▼". The motor will move, indicating that it has memorized the new remote.
6. Press the "▲" button. The awning should then close. If it opens, repeat step 5 of memorizing the remote control and press the bottom button "▼".
7. If the awning still does not close, unplug the power cord again, wait 10 seconds and plug it back in. Then press the bottom button.
8. Since you have a new remote you will eventually need to reprogram the wind sensor, see Appendix 7.D, section Programming the Wind Sensor.



7.F REMOVING THE AWNING FROM ITS SUPPORT BRACKETS

Before removing the awning from the wall or soffits, it is imperative to completely close the awning, unplug the motor from the AC outlet and tie it securely in the closed position with ropes or straps. Once this is all done, remove the mounting hardware for each of the brackets, your awning is now ready to be removed from the brackets.

8 TROUBLESHOOTING GUIDE

INSTALLATION	
Problem	Can I hardwire my awning directly to my house’s electrical system?
Solution	<p>It is possible to hardwire your awning’s motor directly to your house’s electrical system; for that you will need to cut out the AC plug at the end of the cable. Keep in mind that this will void the warranty on the motor and can also cause problems with the programming of the motor.</p> <p>If you opt for this method, never cut the wire more than 30 cm from the motor since this could possibly cut the antenna wire.</p> <p>Also, please make sure to have a power switch accessible near the assembly to facilitate the programming procedure.</p>
Problem	What is the minimum and maximum slope of my awning?
Solution	<p>Minimum 5 degrees, maximum 15 degrees. Even if you can mount your awning higher, you must ensure enough slope for the flow of water. The steeper the slope, the more water can run off.</p> <p>The awning is not made to withstand accumulations of water or snow when open and could be damaged.</p>
FABRIC	
Problem	The fabric of my awning makes small wrinkles, all in the same direction, is this normal?
Solution 1	<p>The fabric is off-centre, you must ensure that it is centred on the roller and on the front bar.</p> <p>The awning must be completely open, if it is motorized, you will have to open it by exceeding the opening limit using the crank. The fabric will be completely loose and you will see the metal of the roller through the opening in the housing.</p> <p>Pull the fabric close to the roller cavity. The fabric should slide into the groove. You have to pull towards the side opposite to the direction of the</p>

	folds and check that it is opposite the fabric on the front bar. Close the awning and test.
Solution 2	If the fabric is not perfect at the right angle, you will need to use Velcro as a wedge to thicken the roller on the side which is too long. Contact us for further details.
Problem	The fabric of my awning makes small wrinkles, on each side of the seams, but not elsewhere. What causes this?
Solution	This is normal. These small folds are caused by the sewing process which causes the fabric to be slightly thicker than the rest of the fabric.
Problem	My awning closes completely on one side but it always remains open a little on the other side.
Solution 1	<p>The fabric is off-centre, you must ensure that it is centred on the roller AND on the front bar.</p> <p>The awning must be completely open, if it is motorized, you will have to open it by exceeding the opening limit using the crank. The fabric will be completely loose and you will see the metal of the roller through the opening in the housing.</p> <p>Pull the fabric close to the roller cavity. The fabric should slide into the groove. You have to pull towards the side that fully closes when the awning is closed.</p> <p>Close the awning and test.</p>
Solution 2	If the fabric is not perfectly square, you must use Velcro as a “wedge” to thicken the roll on the side that is too long, which corresponds to the side that remains a little open. Contact us for more details.
Problem	When my awning is open, one side of the front bar is always higher than the other.
Solution	<p>Although the awning is adjusted at the factory, a difference of a few mm in the position of the supports can have an impact of several cm on the final slope result.</p> <p>This means you will have to adjust the slope of the awning. The slope of the two (2) arms can be adjusted separately, see appendix 7.A.</p>
Problem	I have noticed some small irregularities in my fabric such as embossing and mottling. Is this normal? How can I make them disappear?
Solution	Our fabrics are woven from an acrylic fibre. You may notice some small irregularities after installation: slight embossing, some mottling or small creases along the seams. The waterproofness and solidity of the fabric are not affected in any way. These deformations are due, among other things, to handling during sewing, manufacturing and assembly. In

addition, acrylic fabrics treated with resins may show visible mottling against the light due to an optical effect. Barely noticeable, these irregularities are inherent to the nature of the acrylic fibre.

Can I make them disappear?

Yes! Although the performance of your canvas will not be affected in any way, it is possible for you to reduce these deformations. However, in some cases, it might be difficult to make them disappear completely. Time will be your ally. It is simply a matter of sprinkling the canvas with a little water and letting it dry in the sun. After just a few cycles, the irregularities will disappear or at least fade away.

FUNCTIONING ISSUES

Problem	I have a wind sensor but my awning does not close when it is windy.
Solution 1	Check if the awning closes and opens with the remote control. If positive, replace the wind sensor batteries with new ones. Please note that you must unplug the motor to replace the batteries. Do not use rechargeable batteries.
Solution 2	If your awning is fully open, close it about 2', then wiggle the front bar to see if it closes. Make sure the buttons on the remote are not reversed “▲” to close and “▼” to open. Test if the wind sensor and the remote control are well programmed. See Appendix 7.D
Solution 3	Is the wind sensor properly installed on the front bar, near one end? If not, see Appendix 7.D . The wind sensor should also be facing the correct way with the arrow moulded into the base pointing up.
Problem	I have a wind sensor and it closes my awning when it is not windy.
Solution 1	The awning closes every 30 minutes : Replace the batteries in the wind sensor with new ones. Unplug the motor before changing the batteries. Do not use rechargeable batteries.
Solution 2	The wind sensor sensitivity is too high. Calibrate the wind sensor by following the steps in Appendix 7.D .

Problem	My remote control does not make my awning open or close.
Solution 1	<p>If your awning is almost closed but not fully, it can sometimes refuse to close completely. You just need to open it a bit and close it again completely.</p> <p>You might have to reprogram the awning's limits, see Appendix 7.B.</p>
Solution 2	<p>If the awning stops while running or just after moving, the overheat protection may be activated. Wait at least 20 minutes and try again.</p>
Solution 3	<p>When the wind sensor closes the awning, the awning refuses to open for at least 10 minutes.</p> <p>After the delay of approximately 10 minutes, operation will return to normal.</p>
Solution 4	<p>Check if the AC electrical outlet is functional by plugging in another device, such as a lamp.</p> <p>If the outlet works, but the awning does not work, test the remote control. Check the batteries of the remote control by pressing one of the buttons on the remote control, is the LED light flashing? A remote with a low battery will take longer to turn on the LED light and will have reduced range.</p> <p>If the LED light does not flash, change the battery for a new one; it is a CR2430 lithium battery.</p> <p>If the problem persists, erase the motor programming and program it again, see Appendices 7.C and 7.D.</p>
Problem	My motor is not responding but it was working just minutes ago.
Solution 1	<p>If your awning is almost closed, but not completely, it may refuse to close completely. If this happens, open it a little and try closing is again.</p>
Solution 2	<p>If the awning stops while opening or closing or immediately after it has moved, this could indicate that the overheating protection has been triggered; if this is the case, wait for at least 20 minutes or longer if it is hot outside before trying another command.</p>
Solution 3	<p>When the wind sensor closes the awning, the awning refuses to open for at least 10 minutes.</p>

Problem	The fabric is rubbing on the inferior part of the structure, what causes this?
Solution	<p>The fabric rolls upside down (it comes out from under the roll) on the fabric roller; the fabric should exit the housing from the top of the roller.</p> <p>If the awning is motorized, unplug it. For motorized or manual awnings, use the crank to open the awning until the fabric is completely loose.</p> <p>Continue to turn in the same direction until the fabric becomes tight again and starts rolling from the top of the fabric roller and closes completely. Be very careful when re-tightening the fabric so that it does not catch in the arms. Make sure that the fabric does not come loose again and rolls upside down, the rubbing will cause premature wear and tear to your fabric.</p>
Problem	Can I add more than 1 remote control?
Solution	Yes, the Dooya motor cans memorize more than 1 remote control.
Problem	I lost my remote control and cannot program my new one.
Solution	Go to Appendices 7.C and 7.D.
Problem	The awning stops before it is completely opened or it opens too much and the fabric becomes loose.
Solution	The opening limits needs to be adjusted, refer to Appendix 7.B.
Problem	Can other remote controls interfere with my awning?
Solution	<p>No, each remote must be added to the awning.</p> <p>Garage door openers or other remote controls cannot communicate with your awning. If, on the other hand, a close neighbour has also provided an awning, there could be interference.</p> <p>In this case, you should ask the neighbour to unplug his awning while you program your remote control. Then they just have to plug in their awning.</p>

Contact Us:

Auvents Multiples Inc.

Salle de montre/Showroom : 1505A rue de l'Industrie, Beloeil, QC J3G 0S5

Usine/Factory : 1701 rue de l'Industrie, Beloeil, QC J3G 0S5

Téléphone/Telephone : (450) 446-4182

Sans frais/Toll-free+ : (866) 446-4182

www.auventsmultiples.com

www.zonepatio.com

www.zonepatio.ca