

Fig. 1

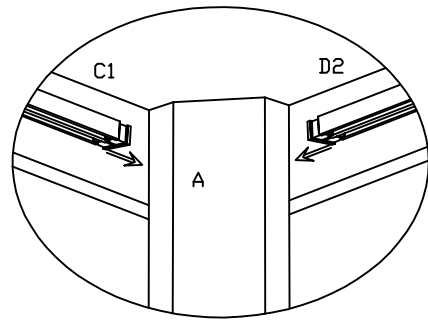

Fig.2

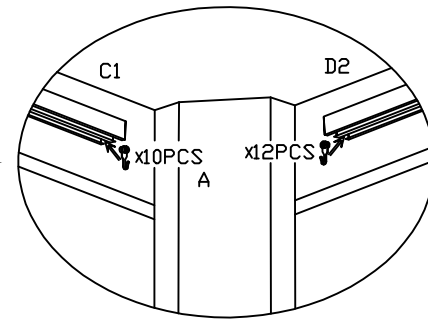

Fig.3

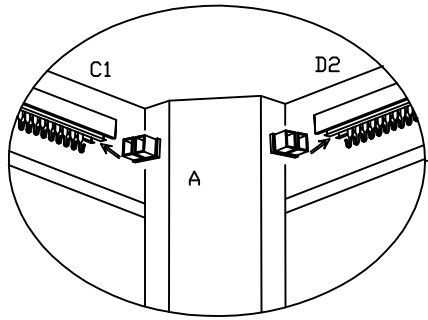

Fig.4

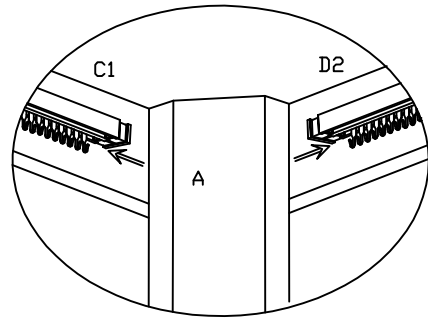

Fig.5

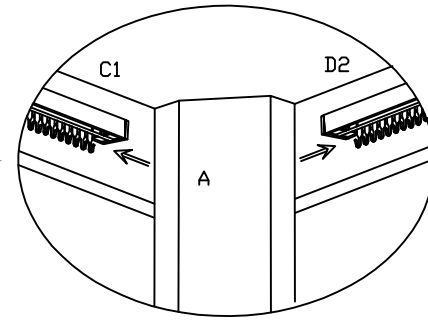

Fig.6

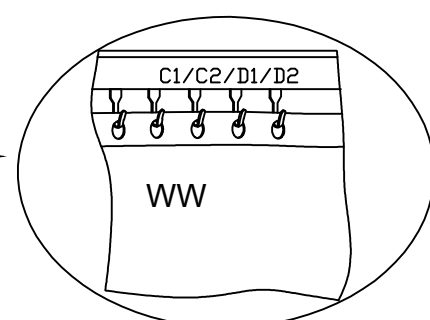
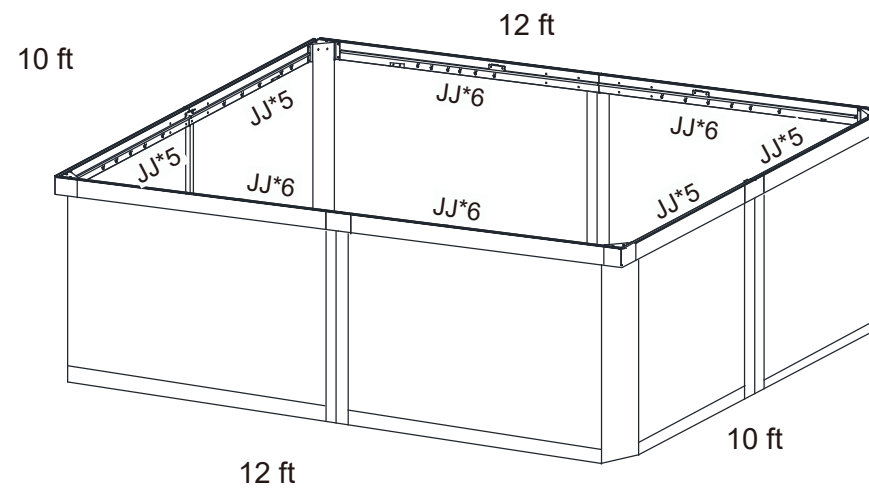

Fig.7

- Step 1: Pull out the track plug, see Fig.1-2.
 Step 2: Plug the hooks into the track,see Fig.3,
 and pay attention to the quantity of hooks.
 Step 3: Plug the track plug into the track,see Fig.4-6.
 Step 4: Hang the Curtain on the hook,see Fig.7.



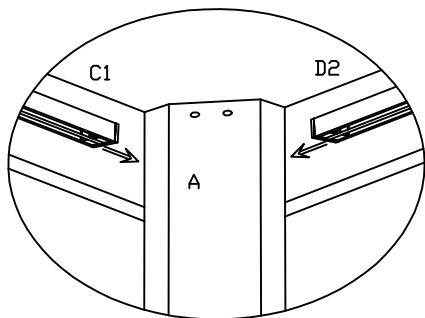

Fig. 1

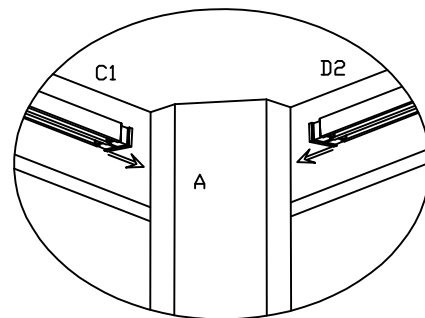

Fig. 2

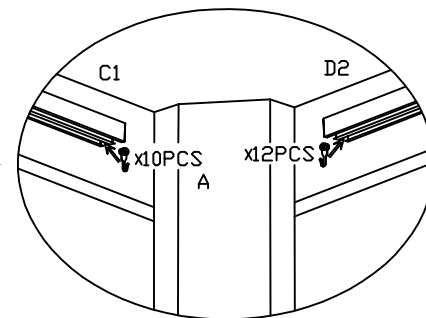

Fig. 3

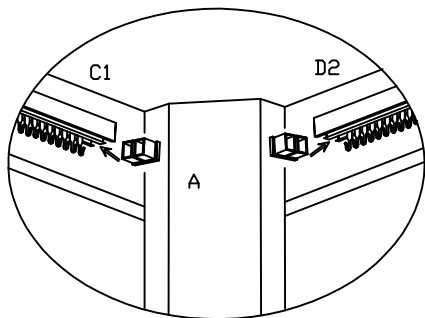

Fig. 4

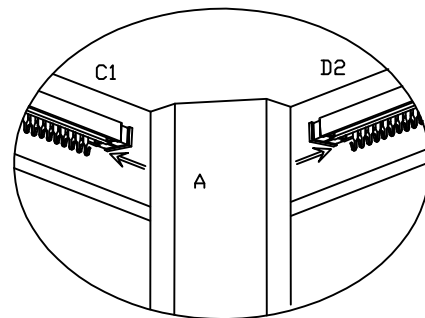

Fig. 5

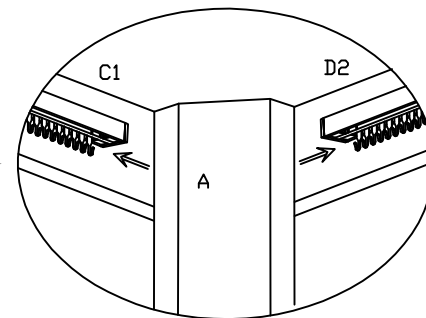

Fig. 6

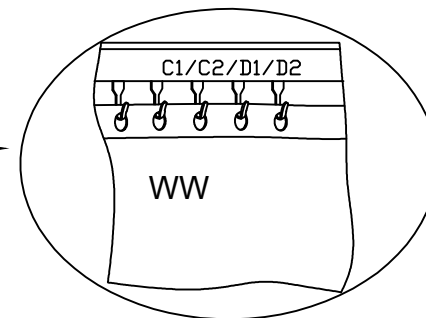

Fig. 7

Étape 1: Retirer le bouchon du rail, voir figures 1-2.

Étape 2: Insérer les crochets dans le rail, voir figure 3, et faire attention à la quantité de crochets.

Étape 3: Réinsérer le bouchon du rail, voir figures 4-6.

Étape 4: Accrocher les rideaux, voir figure 7.

