



CLEAN TOUCH Bidet

CT-7000 Series

CT-7100 / CT-7100R
CT-7200 / CT-7200R

User's Manual

This manual contains the warranty card.
Please read this manual carefully before use.





Please save this manual and place in easily accessible location.
Do not attempt to service this appliance yourself.
Doing so will void warranty.

Table of Contents

01	General Information	
	Safety Information - Warning	4
	Safety Information - Caution	6
	Product Features	8
	Product parts	10
<hr/>		
02	Installation	
	Before Installation	14
	Product Installation	15
	Remote Installation	17
	Trial Operation	18
<hr/>		
03	Operation	
	General operation	19
	Expert Mode	24
<hr/>		
04	Technical Information	
	Maintenance	28
	Error code	30
	Specifications	31
	Comparison Chart	32
	Dimensions	33
	Warranty	34

Safety Features

Warning

Risk of electric shock, fire, personal injury, property damage or products damage when violating the instructions.

- Do not disassemble, modify or repair the product yourself.
- Do not plug or touch the power plug with wet hands.
- Do not pour excessive water onto the products or power plug.
- Do not use the damaged power plug, cord and outlet.
- This products should be used with a grounded outlet.
- Insert the power plug correctly in proper voltage outlet.
- Do not place cigarettes or flammables near the product. Do not litter into the product.
- Do not use industrial water, or gray water for the supply
- Do not plug in until the unit is completely installed
- The unit should be serviced by an authorized or qualified technician if it has a damaged power cord.
- Make sure that drying opening area is not blocked.
- Unplug first before cleaning the unit.
- Do not use the product in locations exposed to excessive moisture.
- Do not use the product if it has fallen into water. Unplug the unit immediately and call the service center.
- This unit is not intended for use by persons (including children and seniors) with reduced physical, sensory, or mental capabilities, or lack of experience and knowledge.

Safety Information

Caution

Risk of electric shock, fire, personal injury, property damage or products damage when violating the instructions.

- Do not stand on the top of or place any heavy objects onto the seat cover.
- Do not open/close the lid/seat with excessive force.
- Do not lean against the lid when opening with excessive force.
- Do not press the buttons using excessive force.
- Do not use thinner, benzene, acidic chemicals, chloride, or hydrochloric acid detergent on or near the product, This may result in corrosion to the metal parts or discoloration, breakage or scratches to the bidet body.
- Do not use any aerosol(spray) products near by. This may result in discoloration of the bidet body.
- Do not pull out the bidet hose using excessive force.
- Be cautious of the low-temperature burn.
- For children and seniors who may have difficulties with adjusting temperatures or those with sensitive skin or impaired heat sensitivity, set the temperature of the wash spray and seat to "low" or "off" to prevent burning.
- If the unit will not be used for a long period of time, unplug the power cord, and close the main water supply valve.
- Do not use the unit if it is not working properly.
- Make sure the unit is installed(mounted) on the installation bracket thoroughly.
- After the installation, make sure to check all water supply connections for leaks. Rubber washers should be in place for the water connection hoses and T-valve
- Do not store or place the unit upside down.
- Children should be supervised to ensure that they do not play with the unit.

Safety Features

Warning

Risk of electric shock, fire, personal injury, property damage or products damage when violating the instructions.

TURBO

- Remove the water in the rectum after using Turbo function, or you may feel bloated or uncomfortable.
- If you have hemorrhoids or anal disease, be sure to consult with your doctor before use. Excessive use may worsen bowel function.

2X MODE

- When using 2X mode, intake water temperature may affect the water spray temperature.
- Be sure to consult your doctor before use if you have hemorrhoids or anal disease.
- Excessive use is not recommended.

Cleaning the bidet body

- Do not use thinner, benzene, acidic chemicals, chloride, or hydrochloric acid detergent on or near the product. This may result in corrosion to the metal parts or discoloration, breakage or scratches to the bidet body.
- Do not use any aerosol(spray) products nearby. And do not sit on the seat after applying excessive body lotion. This may result in discoloration of the bidet body.

Water supply hose and power cord

- Be careful not to drop any chemical detergents of the toilet cleaner on the water supply hose or power cord.
- If exposed to the chemical detergent, remove it immediately.
- The new water hose with the appliance should be used and the old hose is not recommended to be reused.

Safety Information

Caution

Risk of electric shock, fire, personal injury, property damage or products damage when violating the instructions.

Water filter

- In the case of a use environment where tap water has rust, it may cause internal contamination and leakage of the product. Be sure to use a genuine water filter.

Instant heating

- Instant ceramic heating system provides an endless water washes. However, when using in a very cold area with high water pressure, the hot water may not reach the set temperature, and this is not a malfunction. If you lower the water pressure during use, you can use warmer washes.

Warm air dryer

- The dryer effect will be improved if moisture is lightly wiped out before the dry operation.
- The temperature of hot air drying may vary depending on the surrounding temperature even with the same setting.

Toilet bowl flatness

- This product is designed to be placed on the toilet well regardless of toilet flatness, but sometimes the rear of the seat may lift from the toilet if the surface of the toilet bowl is seriously not flat.
- This may cause excessive strain on the toilet seat and bidet body, and may cause damage such as external cracks. Please contact the dealer or manufacturer for additional supports.

Products Features

Ceramic water heating technology

- Instant ceramic heating system provides an endless water washes.

Touch control panel

- By applying the touch control panel with perfect waterproofness equivalent to IPX8, this can be used conveniently without worrying about malfunction even in high temperature and high humidity environments. (limited to side arm models)

IPX5 Waterproof

- Bidet main unit is designed with IPX5 waterproofness level for safety.

Rear/Front wash

- Adjustable temperature, position, pressure, pulsation and oscillation settings.

Enema(Turbo)

- Specialized water spray in Turbo(enema) helps relieve constipation and fecal stasis.

2X mode

- For users who prefer the stronger water pressure, 2X mode offers double-power water spray.

Aerated wash

- A specially designed nozzle tip structure generates an air bubble wash spray for better cleansing performance.

Stainless steel nozzle

- A fully stainless steel nozzle resists rusting and contamination for better hygiene.

Multicolored, illuminating nightlight

- Choose a preferred nightlight to provide enough brightness to find a toilet without turning on the light at night.

Product Features

2 Energy Saving modes

- Offers 2 different energy-saving modes to maximize the electricity saving.

2 Nozzle Cleansing modes

- Offers 2 different nozzle cleansing modes to enhance the hygiene.

Nozzle/Dry Protection Cover

- Prevents a nozzle and dry outlet from any contaminations with a protection cover for easy cleaning and maintenance.

Intensive Nozzle Care

- Provides a more hygienic environment for use by intensively cleaning only the contaminated nozzle tip.

Quiet Pump

- Available powerful water flow with low noise pumping operation sound by applying the new wave control technology.

Enhanced Dry Airflow

- Enhanced dry fan motor and specially designed outlet structure offer quick drying.

Automatic Leveling Seat

- Minimizes seat damage due to the uneven surface of the toilet bowl by an applying automatically adjustable leveling seat system.

Radio Frequency Remote

- Perfect remote control without interference in bathroom structure and other lights by applying radio frequency remote.

User Preset

- Set water temperature, seat temperature, water pressure, nozzle position, dry temperature, oscillation, and pulsation for two users.

Product parts

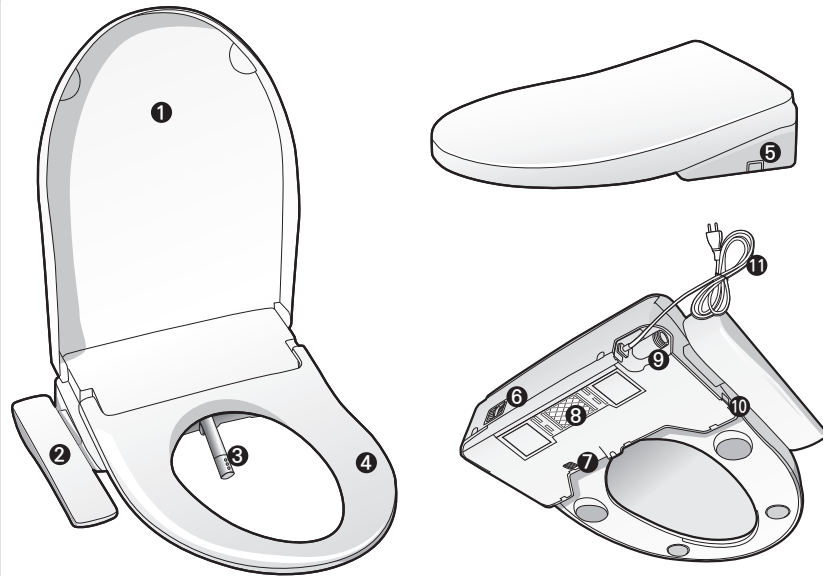

- | | | |
|---------------------------|-----------------|------------------------------------|
| ❶ Lid | ❷ Control panel | ❸ Nozzle |
| ❹ Seat | ❺ Release lever | ❻ Deodorizing cover and air outlet |
| ❼ Intake deodorizing hole | ❽ Catch plate | ❾ Water inlet |
| ❿ Night light | ⓫ Power cord | |

Installation parts

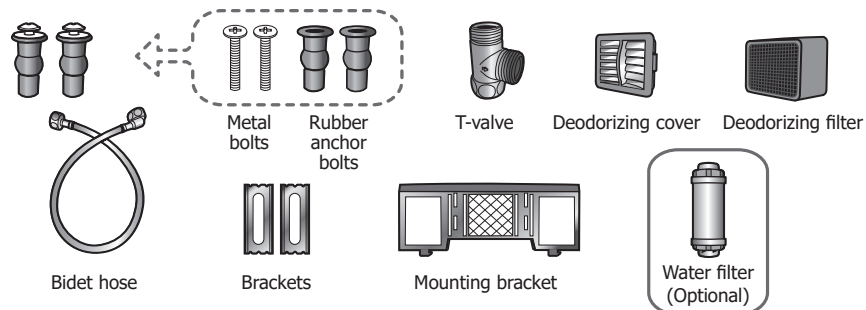

Control panel

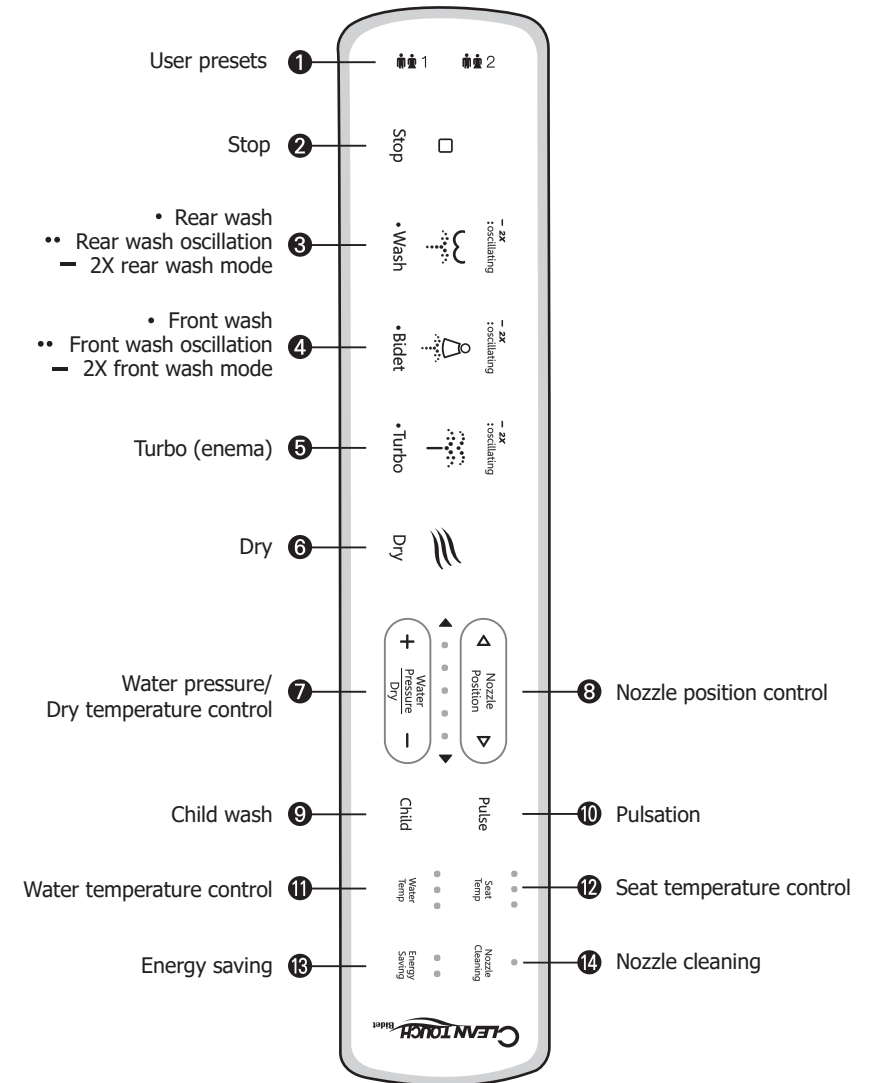

• Select once / •• Select once again / — Select and hold for 3 seconds

Product parts

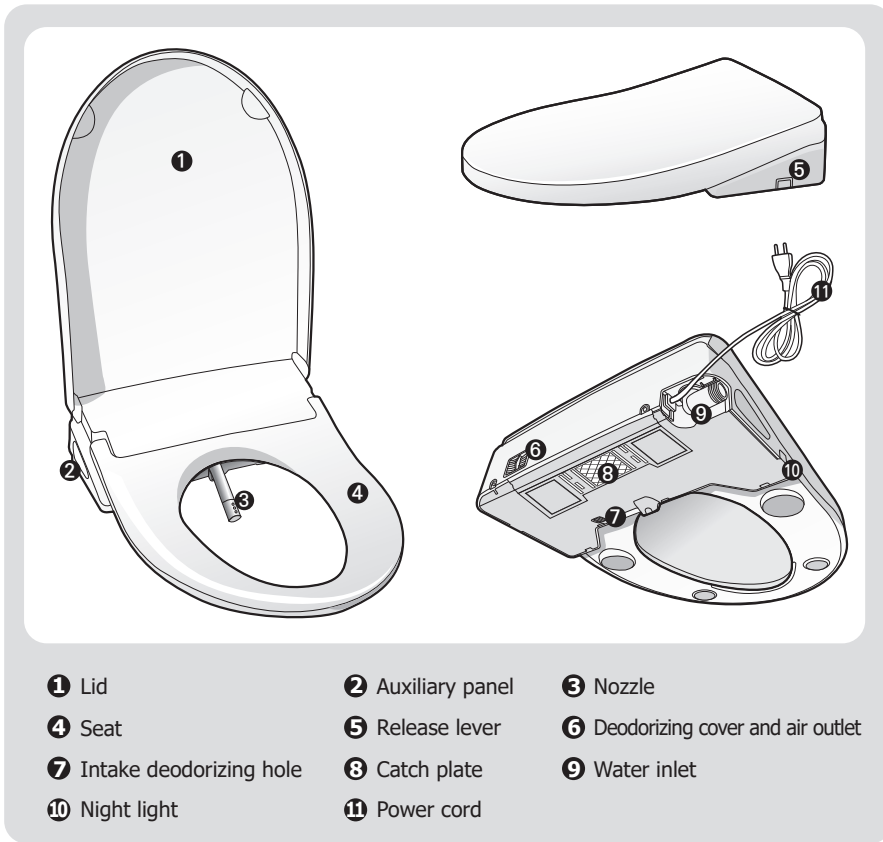

Installation parts

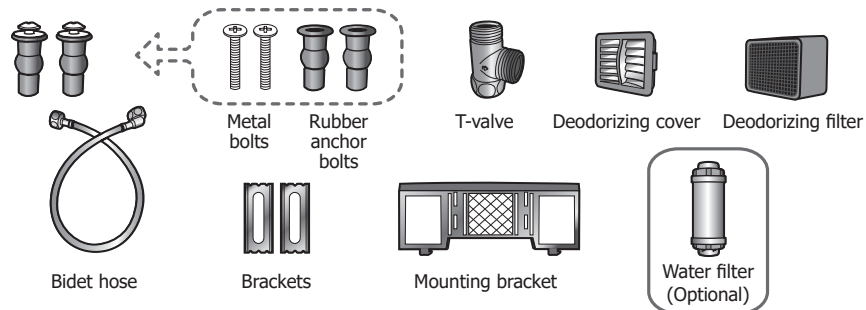

Control panel

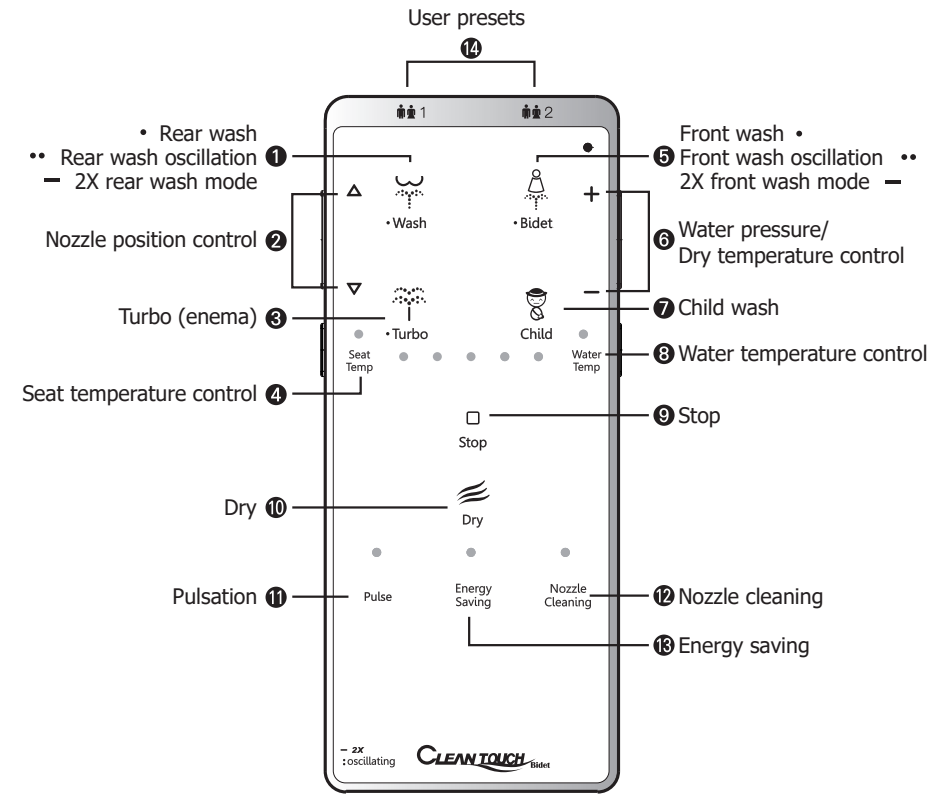

• Select once / •• Select once again / - Select and hold for 3 seconds

Parts for remote control

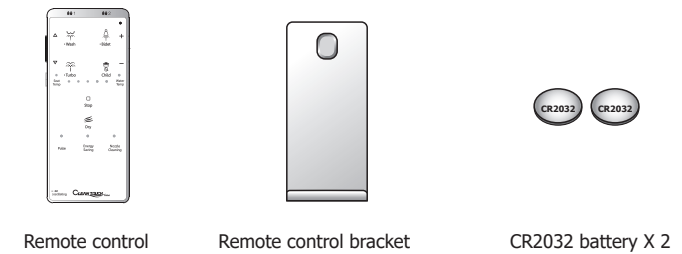

Before installation

Caution

Do not plug the product in until the unit is completely installed.

- Read the manual first before installation.
- Check whether the toilet to be installed is suitable for the installation
Toilet size, mounting hole spread, shutoff valve installed, Space for T-valve, flexible hose installed, etc. For this, contact the local dealer where you purchase your bidet seat for special assistance.
- Prepare the standard screwdriver and wrench in advance.
- Teflon tape may be needed between plumbing connections
- Every product is tested with pure water during production to ensure the highest quality and performance. It is normal to find a small amount of residual water drops or moisture on the product.

Product Installation

1. Remove the seat from the existing toilet

- Release the nuts and then remove the seat and cover.
- Keep the removed seat, cover and nuts in a proper place in case of using them again.



2. Shut the supply off, and empty the tank completely

- Connect with the cold water supply only.
- Failure to do may result in flooding, leaking or damage to the product when the hose is disconnected.

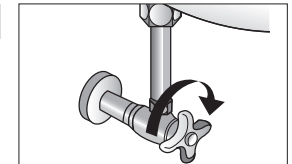

3. Disconnect the toilet hose and install the T-valve

- You may use the bucket to catch the residual water from the hose.
- Check and ensure the rubber washer sits flat inside of the T-valve.

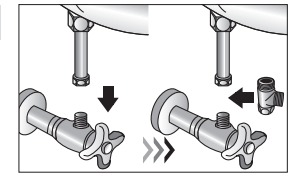

4. Install the catch plate

- Wet the rubber anchor bolts with water and firmly insert them all the way down into the mounting holes on the top of the toilet.
- Place the mounting plate over the rubber anchor bolts on the toilet.
- Place the brackets flat side down on the mounting plate over the rubber anchor bolts. Insert metal mounting bolts through the holders and rubber anchor bolts; use a screwdriver to screw in the mounting bolts and tighten.
- If the toilet bowl is not suitable to use mounting anchor bolts, contact the local dealer where you bought your product for more assistance.

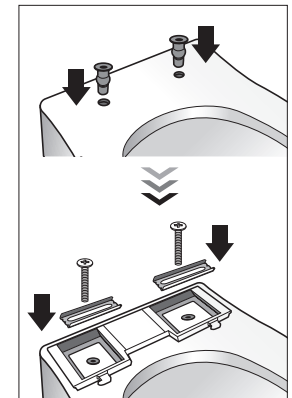

5. Insert the deodorizer filter ※ Applicable models only

- Insert the deodorizer filter into the cartridge hole.

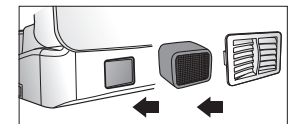

Product Installation

6. Attach the bidet seat to the catch plate

- Adjust the seat and front part of the toilet back and forth so that they can correspond before fastening the bolts.
- Set the bidet seat flat on the toilet bowl and push it in until it clicks into place and is secure. Failure to do so may cause the seat to come apart.

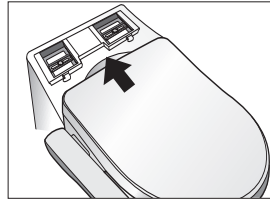

7. Connect the bidet hose to the bidet seat

- Rotate the water inlet backward and hand-tighten to secure. Make sure the hose is not twisted, excessively bend it, or strip the plastic threads when screwing the hose onto the bidet seat.
- After connection, rotate the inlet back to the normal position.
- Connect the other end of the hose to the T-valve. Check and ensure the rubber washer is not twisted when fastening.

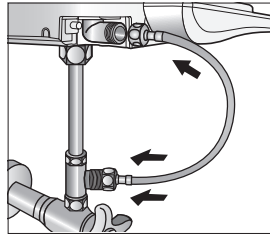

※ Bidet Filter Installation

- Customers with hard water, well water, and rust water can extend the life of their bidet seat by installing an inline water filter.
- Install the filter between T-valve and bidet hose.
- The bidet filter should be replaced every 4~6 months.
- Failure to replace the filter on time may result in water contamination, supply congestion, or filter breakage.

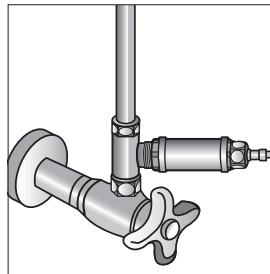

Remote Installation

1. Find a place visible and reachable from the toilet and clean the space thoroughly before attaching the bracket.

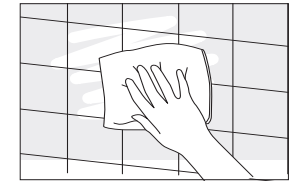

2. Peel the adhesive protection film and attach the bracket on the wall.

3. Insert the batteries deeply inside first and press the outside all the way down to complete the insertion. Be sure to fasten the bolt for children's safety.

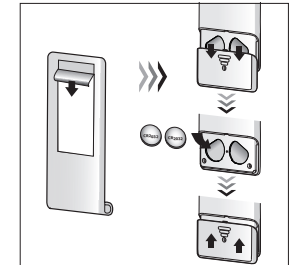

4. Gently insert the remote control into the bracket.

5. If the automatic pairing is failed, follow the below instructions.

- Plug in the bidet seat.
- The nozzle comes forward and goes backward, then melody plays.
- Insert the batteries.
- Press any buttons to complete the pairing. Melody is played to identify pairing completion.

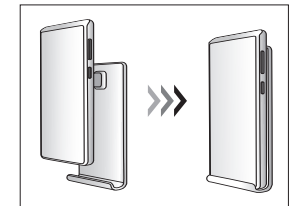

6. Replace all batteries at the same time. Do not mix old and new batteries.

- Keep the battery out of reach of infants and toddlers and watch out them not to swallow it. If a battery is swallowed, immediately consult a doctor.

※ Caution for pairing

- Be sure to proceed in the order of pairing method. If the order is reversed during pairing, remove the remote control batteries and product power cord, wait tens of seconds, and start again from the beginning.
- To automatically pair the remote to the seat, install the batteries into the remote within 5 minutes of plugging the seat into the power outlet.
- This product is an RF-type remote control with its own unique number assigned to each product. There is little chance of confusion if two or more remote control bidet seats are installed at the same place. In this case, contact the local dealer where you purchase your seat for more assistance.

Trial Operation

1. Turn on the water supply

- Make sure the flush tank is filled up with water.

2. Check all connections for leaks, including T-valve and hose connections

- In case of leakage, check the tightening of the nut and whether the rubber washer is missing or twisted, and Teflon tape may be required depending on the installation environment.

3. Plug in

- Do not touch the plug with wet hands.

4. Check the initial operation

- The night light blinks while the nozzle extracts and retracts.

Operations

Occupied seat sensor (getting started)

- Sit on the seat to ensure skin contact on the seat sensor.
- Clothes or other materials except for skin contact on the seat sensor may interrupt the bidet seat operation.
- Once the contact is made the water pressure indicator lights will turn on.
- Leaving the seat during use will stop the operation.

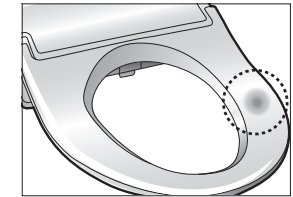

Stop

- Stops all wash and dry functions currently operating (Side arm/Remote control)
- Gently touch for a second any parts of the dotted area to stop the wash cycle. (Auxiliary panel)

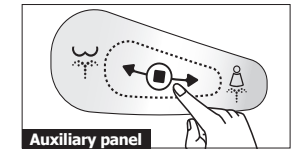

Rear wash / Front wash / Turbo wash / Oscillation

- Select once to initiate a rear/front/turbo wash. The nozzle will be self-cleaned before/after wash operation. (Turbo wash is not available with the auxiliary panel.)
- Select once again to initiate nozzle oscillation. To stop the oscillation, choose again. The oscillation at Turbo wash is not available for safety.
- Do not use a Turbo wash excessively and consult with a doctor first if you have any anal disease or you are sensitive.
- For water temperature when using in a cold environment, refer to the cautions in this manual.
- Swipe finger toward the front to initiate a front wash. Swipe finger toward the front again to initiate an oscillation. (Auxiliary panel only)
- Swipe finger toward the rear to initiate a rear wash. Swipe finger toward the rear again to initiate an oscillation. To cancel the oscillation, swipe the same direction again. (Auxiliary panel only)

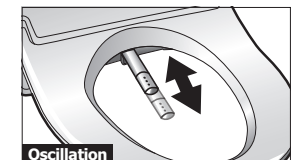
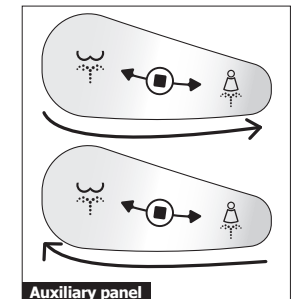
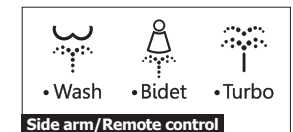

Operations

2X mode

- If the stronger water pressure is preferred while a rear/front wash, select and hold a button for 3 seconds to change to 2X mode. 2X mode starts from Level 3 regardless previous setting.
- Select and hold a rear/front wash button for 3 seconds to initiate 2X mode rear/front wash.
- Select once again to initiate nozzle oscillation. To cancel the oscillation, select again.
- To cancel 2X mode, select and hold a rear/front wash button for 3 seconds.
- Do not use 2X mode wash excessively and consult with a doctor first if you have any anal disease or are sensitive.
- For warm water temperature when using in a cold environment, refer to the cautions in this manual.

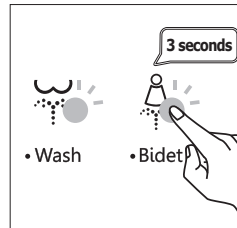

Child wash (automatic wash)

- Select a Child wash button to initiate an child wash that offers from the wash until the drying function for children and seniors.
- Rear wash 20 seconds → Rear wash oscillation 20 seconds → Rear wash oscillation with pulsation for 20 seconds → Dry for 2 minutes will consecutively work.



Dry ※ Applicable models only

- Select a dry button to initiate a 3 minutes air dryer cycle. Dryer air temperature can be adjusted by +/- button. (5 levels)
- For dryer air temperature when using in a cold environment, refer to the cautions in this manual.

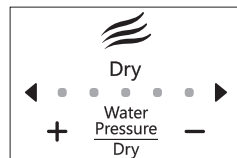

Pulsation

- Select a pulsation button to initiate pulsation while rear/front/turbo is running that enables the water to repeatedly increase and decrease in pressure in a pulsating pattern.
- To cancel pulsation, select the pulsation button again.

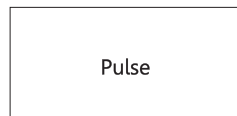

Water pressure

- Select a rear/front/turbo wash button to adjust water pressure by +/- button. (5 levels)
- If you feel that the water pressure is weaker than usual, there may be small debris stuck in the water supply screen filter or inline filter. Refer to maintenance instructions in this manual.

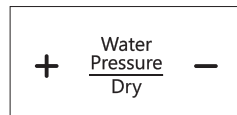

Operations

Nozzle position

- Select </> during a wash cycle to adjust the nozzle position forward and backward.
- The 5 LED indicator lights will indicate different positions selected. Settings will be saved for the next use.



Seat temperature

- Select a seat temperature button to adjust the seat temperature to 1 of 4 settings.
- Room temperature/off → low/green(34°C/93.2°F) → medium/yellow(37°C/98.6°F) → high/red(40°C/104°F)
- Settings will be saved for the next use.
- If the seat is used 15 minutes consecutively when the seat temperature is set at medium and high, the seat temperature will be lowered automatically down to 35°C/95°F by 1°C/1.8°F every 5 minutes.
- For safety, this bidet seat uses a low voltage for a heated seat. It may take a little while to be heated at the beginning.

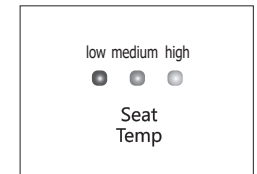

Water temperature

- Select a water temperature button to adjust the seat temperature to 1 of 4 settings.
- Room temperature/off → low/green(34°C/93.2°F) → medium/yellow(37°C/98.6°F) → high/red(40°C/104°F)
- Settings will be saved for the next use.
- This bidet seat is an instant heating system with the latest technology applied, and it does not consume any electricity for the water heating in standby mode, saving electricity.
- If the bidet seat is used in a very cold area with high water pressure, the warm water may not reach the set temperature. Refer to the precaution in this manual.

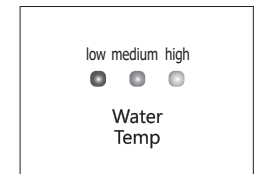

Deodorizer ※ Applicable models only

- The deodorizer starts automatically when a user sits on the seat. It continues to run for one minute after the seat has been vacated.
- The deodorizing cartridge is semi-permanent but needs to be cleaned regularly with a brush.

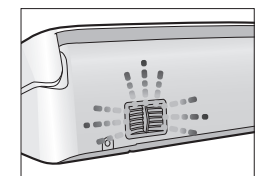

Operations

Energy saving

- Select the Energy saving button once to initiate the Energy saving mode 1. Select it again to initiate the Energy saving mode 2. To cancel the Energy saving mode, select it once again after the Energy saving mode 2.
- No energy saving (off) → Energy saving mode 1 (green) → Energy saving mode 2 (red)



Energy saving mode 1 (regular saving)

Seat temperature is lowered as below and goes back to the previous set temperature automatically as soon as the seat is occupied.

- Low temperature (34°C/93°F) → (28°C/82°F)
- Medium temperature (37°C/99°F) → (30°C/86°F)
- High temperature (40°C/104°F) → (32°C/90°F)

Energy saving mode 2 (powerful saving)

Seat heating is turned off regardless of the current temperature setting and goes back to the previous set temperature automatically as soon as the seat is occupied. After a seat is unoccupied, it returns to Energy-saving mode.

The night light dims during the Energy saving mode 2 and when a user sits on the seat, it becomes bright and dims back after leaving the seat.

Multicolored night light

- Select a nozzle cleaning button repeatedly to change the color of the night light 1 of 7 colors while the seat is occupied.
 - The default color is white and can be changed in the following order.
 - Pure white → Sky blue → Pretty yellow → Princess pink → Hot red → Sea blue → Forest green → Off
- The night light dims during the Energy saving mode 2 and when a user sits on the seat, it becomes bright and dims back after leaving the seat.

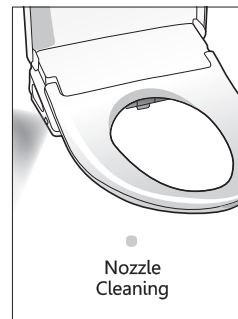

Factory default reset

- To reset the bidet seat back to its factory default settings, select the stop button 4 times within 2 seconds to clear all current settings.
- A factory reset can only be performed when the seat is not occupied.
- A tone will be heard to confirm that the bidet seat has been initialized.



Operations

Nozzle cleaning

- There are two ways to initiate nozzle cleaning.

Nozzle cleaning 1 (nozzle body care)

Select Nozzle cleaning for a second while not seated. Nozzle extends toward and self-clean 3 times with cold water. It retracts when finished. Pressing Stop at any time to cancel the nozzle cleaning process.

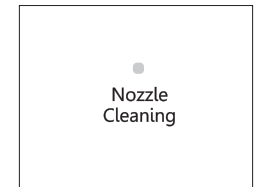

Nozzle cleaning 2 (Nozzle tip intensive care)

Select and hold the Nozzle cleaning button for 3 seconds while not seated. Nozzle extends toward and nozzle tip will be self-cleaned for 40 seconds with hot water.

- It stays extracted for user's manual cleaning for 5 minutes and retracts automatically.
- Select the Nozzle cleaning button again to retract the nozzle if the cleaning process is finished earlier.
- Select the Nozzle cleaning button while the nozzle tip is being self-cleaned, and self cleaning is canceled and extracts promptly for user's manual cleaning.

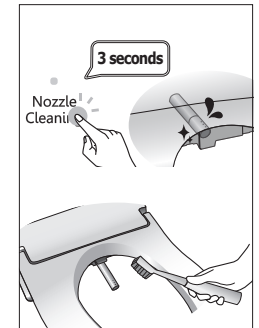

User preset

- You can program your preferred settings for two users. Follow the steps below to program and use the memory function.
- Water temperature, seat temperature, water pressure, nozzle position, and dry temperature can be stored.
- Use the bidet seat with your preferred settings first and select and hold one of the user preset buttons for 3 seconds. Settings will be saved with 1 beep.
- Settings can be overwritten on the current presets. In this case, old settings are deleted and new settings are saved.
- Select the user preset 1. 2 LEDs(green/red) of Energy saving light on and only green LED blinks once altering you that user memory 1 is activated.
- Select the user preset 2. 2 LEDs(green/red) of Energy saving light on and only green LED blinks twice altering you that user memory 2 is activated.

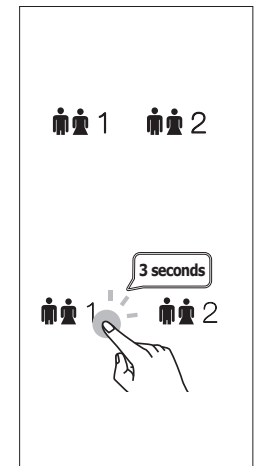

Sleep mode

- Select and hold Energy-saving for 3 seconds to enter Sleep mode regardless of the seat sensor occupation. Select Energy-saving again for a second to cancel the sleep mode.

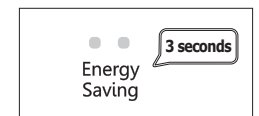

Expert mode

Expert mode allows the user to program the operations. It may be complicated for regular users.

Entering & canceling Expert mode

- Select and hold Nozzle Cleaning for 2 seconds while Stop is selected and held to enter/cancel the expert mode.
- Nozzle Cleaning LED blinks to indicate Expert mode has been entered.
- The seat sensor is automatically overridden and, if the overriding is not canceled forcibly, it is canceled after 20 minutes automatically.

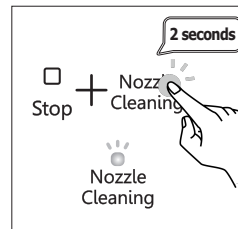

Seat occupy sensor overriding and canceling

- After entering Expert mode, touch a seat sensor area to deactivate the seat sensor override. 5 LEDs of water pressure/nozzle position are turned off to indicate that the seat sensor override is deactivated.
- Touch the seat sensor again to activate the seat sensor override. 5 LEDs of water pressure/nozzle position turn on to indicate that the seat sensor override is activated.

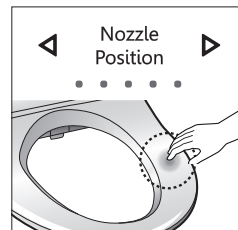

Wash cycle change

- Deactivate the seat sensor override.
- Select Water temperature while Rear wash is selected and held.
- Color of Water temperature LED is changed sequentially. 1min(off) → 2min(low/Green blinks) → 3min(medium/yellow blinks) → 5min(high/red blinks).
- Cycle of front wash and Turbo wash can be changed in the same way.
- Default cycle is 2 minutes.

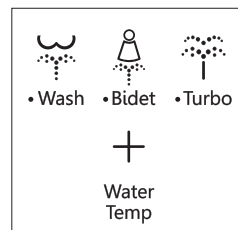

Expert mode

Dry cycle change

- Deactivate the seat sensor override.
- Select Water temperature while Dry is selected and held.
- Color of Water temperature LED is changed sequentially. 1min(off) → 2min(low/Green blinks) → 3min(medium/yellow blinks) → 5min(high/red blinks).
- Default cycle is 3 minutes.

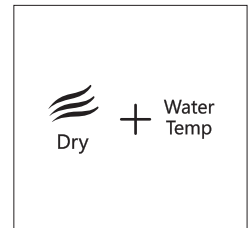

Child wash cycle change

- Deactivate the seat sensor override.
- Select Water temperature while Child wash is selected and held.
- Color of Water temperature LED is changed sequentially. 30sec(off) → 60sec(low/Green blinks) → 120sec(medium/yellow blinks) → 180sec(high/red blinks)
- 30sec(off) : 10sec front wash → 10sec front oscillating wash → 10sec front oscillating/pulsating wash
- 60sec(off) : 20sec front wash → 20sec front oscillating wash → 20sec front oscillating/pulsating wash
- 120sec(off) : 40sec front wash → 40sec front oscillating wash → 40sec front oscillating/pulsating wash
- 180sec(off) : 60sec front wash → 60sec front oscillating wash → 60sec front oscillating/pulsating wash
- Default cycle is 60 seconds.

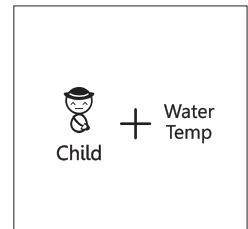

Dry cycle change at Child wash

- Deactivate the seat sensor override.
- Select Seat temperature while Child wash is selected and held.
- Color of Seat temperature LED is changed sequentially. 30sec(off) → 1min(low/Green blinks) → 2min(medium/yellow blinks) → 3min(high/red blinks).
- Default cycle is 2 minutes.

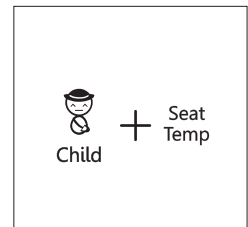

Expert mode

Automatic deodorize on/off ※ For CT-7200, CT-7200R only

- This feature can be set regardless seat sensor override.
- Select Water temperature while Stop is selected and held to initiate/cancel the automatic deodorize.

Side arm 2 LEDs(green/red) of the energy saving blink with 1 beep when it is activated and only the red LED blinks with 2 beeps when it is deactivated.

Remote The yellow LED of the energy saving blinks with 1 beep when it is activated, and the red LED of the energy saving blinks with 2 beeps when it is deactivated.

	<input type="checkbox"/> + Water Temp Stop	
	Side arm	Remote
Activating	Green Red Energy Saving 	Yellow Energy Saving
Deactivating	Red Red Energy Saving 	Red Energy Saving

Automatic pulsation wash on/off

- Deactivate the seat sensor override.
- Select water pressure +/- simultaneously to enter automatic pulsation wash setting mode.
- Select and hold Rear wash for 3 seconds to initiate/cancel automatic oscillation rear wash.
- In the case of Child wash, Child pulsation wash is deactivated first instead of being activated as it is set basically.
20sec front wash → 20sec front-oscillating wash → 20sec front-oscillating/pulsating wash.

Side arm 2 LEDs(green/red) of the energy saving blink with 1 beep when it is activated and only the red LED blinks with 2 beeps when it is deactivated.

Remote The yellow LED of the energy saving blinks with 1 beep when it is activated, and the red LED of the energy saving blinks with 2 beeps when it is deactivated.

	simultaneously Water Pressure Dry	
	Side arm	Remote
Activating	Green Red Energy Saving 	Yellow Energy Saving
Deactivating	Red Red Energy Saving 	Red Energy Saving

Automatic oscillation wash on/off

- Deactivate the seat sensor override.
- Select nozzle position ◀▶ simultaneously to enter automatic oscillation wash setting mode.
- Select and hold Rear wash for 3 seconds to initiate/cancel automatic oscillation rear wash.
- In the case of Child wash, Child oscillation wash is deactivated first instead of being activated as it is set basically.
20sec front wash → 20sec front oscillating wash → 20sec front oscillating/pulsating wash

Side arm 2 LEDs(green/red) of the energy saving blink with 1 beep when it is activated and only the red LED blinks with 2 beeps when it is deactivated.

Remote The yellow LED of the energy saving blinks with 1 beep when it is activated, and the red LED of the energy saving blinks with 2 beeps when it is deactivated.

	simultaneously Nozzle Position	
	Side arm	Remote
Activating	Green Red Energy Saving 	Yellow Energy Saving
Deactivating	Red Red Energy Saving 	Red Energy Saving

Expert mode

Water pressure / Nozzle position / Dry temperature change

- Activate the seat sensor override
- Basically, the water pressure and nozzle position are stored and are maintained from the previous user's settings, but these can be ignored and automatically be changed to the presets as soon as the seat is unoccupied.
- Adjust the nozzle position and water pressure and select and held Rear wash for 3 seconds.
- Water pressure/Nozzle position of Front wash, Turbo Wash and Child wash can be set by selecting and holding each button for 3 seconds.
- Adjust the dryer temperature and select and held Dry for 3 seconds.

Side arm 2 LEDs(green/red) of the energy saving blink with 1 beep when it is activated and only the red LED blinks with 2 beeps when it is deactivated.

Remote The yellow LED of the energy saving blinks with 1 beep when it is activated, and the red LED of the energy saving blinks with 2 beeps when it is deactivated.

	◀ Nozzle Position ▶ + Water Pressure Dry -	
	Side arm	Remote
Activating	Green Red Energy Saving 	Yellow Energy Saving
Deactivating	Red Red Energy Saving 	Red Energy Saving

Silence mode on/off

- Deactivate the seat sensor override.
- Select water pressure +/- while Stop is selected and held to lower the volume of the beep sound.
- The volume of the beep sound will be lowered after getting out of Expert mode.

	<input type="checkbox"/> + - Stop	
--	--------------------------------------	--

Seat Sensor Bypass ※ For CT-7200, CT-7200R only

- Regardless of the seat sensor override, the seat sensor bypass can be set.
- Select and hold Seat Temperature for a couple of seconds to activate while Stop is selected. Repeat to deactivate.
- The yellow LED of the energy saving blinks with 1 beep when it is activated, and the red LED of the energy saving blinks with 2 beeps when it is deactivated.
- During the seat sensor bypass activation, the auxiliary touch panel does not work for safety.

	<input type="checkbox"/> + Seat Temp Stop	
	Remote	
Activating	Yellow Energy Saving 	
Deactivating	Red Energy Saving 	

Maintenance

※ **Dual protection (dryer inner cover and closed nozzle cover) protects the bidet seat from contamination and water damage.**

Cleaning the screen filter

- Turn off the water supply and hold the toilet flush lever down to empty the tank completely.
- Unplug the bidet seat, remove from the toilet and disconnect the bidet hose. You may use the bucket to catch any dripping water from the hose and bidet seat.
- Remove the screen filter from the water inlet with a long-nosed pliers.
- Clean the filter with a toothbrush and re-install it correctly.
- Reconnect the bidet hose and place the bidet seat back, Plug the power cord back and turn the water supply back on. Check for leaks.

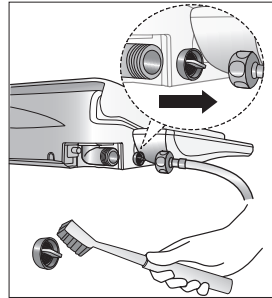

Cleaning bidet seat body

- Do not use thinner, benzene, acidic chemicals, chloride, or hydrochloric acid detergent.
- Do not scrub or use harsh, abrasive products to clean the seat.
- Use a soft, damp cloth and mild cleanser and do not spray water excessively onto the bidet seat.
- If the contamination is serious, use the mild detergent (such as dish soap) only and make sure there is no residue after cleaning.
- Do not use any aerosol(spray) products nearby. This may result in discoloration of the bidet body.
- Unplug first before cleansing, and be aware of not wetting the power plug.
- Be careful of not to drop any chemical detergents of toilet cleanser on the water supply hose or power plug.



Maintenance

Cleaning the bottom and toilet bowl

- Unplug and shut the water supply off, then flush toilet and hold down dandle to completely empty tank.
- Disconnect water supply hose from the bidet seat. You use a bucket to catch any dripping water from the bidet and hose.
- Press the bidet release lever and gently pull inward to remove the bidet seat.
- Use a soft, damp cloth and mild/neutral cleanser (such as dish soap) to wipe down the bidet body and remove the cleanser completely.
- In case of cleaning the toilet, remove the catch plate first. Make sure there is no cleanser left on the toilet after cleaning. Cleanser residue may damage the bidet body.

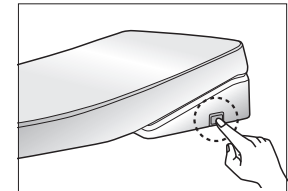
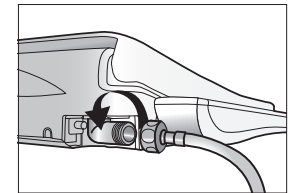

Product storage

- Keep the unit plugged in to prevent freezing if the bidet seat is installed in a cold place.
- When the bidet seat is not used for an extended period of time, unplug. When it is reused after it is stored in a cold place, keep the unit in a warm place for a while before plugging in.

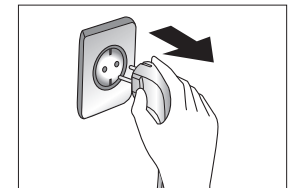
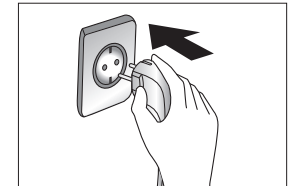

Error code

※ In the event of an abnormality, please refer to the error code table below and inform us at the time of receiving repair service, so that the action may be easier.

Remote model / Side arm model							
Common display	Left	Right			No.		
Energy saving "Green" and "Red" LED sequentially Blink, and Night light "Red" blinks	Seat temperature "Green" LED blinks				1	Disconnected or not inserted seat temperature sensor	
	Seat temperature "RED" LED blinks				2	Short or overheated seat temperature sensor	
	Water temperature "Green" LED blinks				3	Disconnected or not inserted intake water temperature sensor	
	Water temperature "Green" and "Yellow" simultaneously or sequentially blink				4	Short or overheated intake water temperature sensor	
	Water temperature "RED" blinks				5	Disconnected or not inserted outlet water temperature sensor	
	Water temperature "Green" and "Yellow" simultaneously or sequentially blink				6	Short or overheated outlet water temperature sensor	
	○	○	○	○	●	7	Low voltage
	○	○	○	●	○	8	Solenoid valve overcurrent
	○	○	○	●	●	9	Solenoid valve disconnection
	○	○	●	○	○	10	Dry fan motor RPM error
	○	○	●	○	●	11	Deodorizing fan motor overcurrent
	○	●	○	○	○	12	Pump motor overcurrent
	○	●	○	●	○	13	Flow meter disconnection or abnormality
	○	●	○	●	●	14	Overvoltage
	○	●	●	○	●	15	Drying fan motor low/over current

Error code display priority

Error code display is divided into two sections, 1 to 6 and 7 to 15. Error with a smaller number is displayed only. For example, if No. 1, No. 6, No. 8, and No. 15 occur simultaneously, only No. 1 and No. 8 are displayed. If 1 is solved, only 6 and 8 will be displayed, if 8 is solved, 6 and 15 will be displayed.

Specification

Item		CT-7100 / CT-7200	CT-7100R / CT-7200R
Power voltage		AC 120V / 60Hz	
Max power consumption		1,330W	
Power cord		1.2M	
Supply water connection		Directly connects to the water pipe	
Supply water pressure		0.068 ~ 0.735 MPa	
Wash	Volume	Rear wash	650±50cc/min (850±50cc/min at 2X mode)
		Front wash	650±50cc/min (800±50cc/min at 2X mode)
		Turbo(enema)	800±50cc/min
	Pressure control	Rear/Front wash (10 levels incl. 2X mode) Turbo(enema) 5 levels	
	Temperature control	4 levels (Off, low, middle, high)	
	Max heater power consumption	1,400W	
	Safety devices	Thermal sensor, Thermal fuse, Thermal switch	
Heated seat	Temperature control	4 levels (Off, low, middle, high)	
	Max heater power consumption	38W	
	Safety devices	Thermal sensor, Thermal fuse	
Dry	Temperature control	5 levels	
	Heater capacity	400W	
	Safety device	Thermal fuse	
Deodorizer ※ For CT-7200, CT-7200R only		Catalyst Carbon deodorization filter (replaceable)	
Incoming water temperature tolerance range		3 ~ 35°C (12 ~ 35°C recommended) 3 ~ 40°C (10 ~ 35°C recommended)	
Usage room temperature tolerance range		3 ~ 40°C (10 ~ 35°C recommended) 3 ~ 40°C (10 ~ 35°C recommended)	
Product dimensions	Elongated	449mm X 528mm X 112mm	380mm X 528mm X 112mm
	Round	449mm X 500mm X 112mm	380mm X 500mm X 112mm
Remote dimensions		-	66mm X 155mm X 10mm
Product weight		4~4.5kg(6.5~7kg)	
Remote weight		-	105g

Comparison Chart

	Feature	CT-7100	CT-7200	CT-7100R	CT-7200R
Wash - Dry	Rear wash	●	●	●	●
	Front wash	●	●	●	●
	Turbo (Enema)	●	●	●	●
	Child wash	●	●	●	●
	Pulsation	●	●	●	●
	Oscillation	●	●	●	●
	Instant heating	●	●	●	●
	Aerated wash	●	●	●	●
	Built in pump	●	●	●	●
	Drying	●	●	●	●
Convenient feature	Deodorizing		●		●
	Heated seat	●	●	●	●
	User preset	●	●	●	●
	Soft closing	●	●	●	●
	Quick removal	●	●	●	●
	Night light	●	●	●	●
	Nozzle cleansing(2 modes)	●	●	●	●
	Energy saving(2 modes)	●	●	●	●
Seat sensor bypass	●	●	●	●	
Safety feature	Low burn protection	●	●	●	●

Dimension

Side arm model

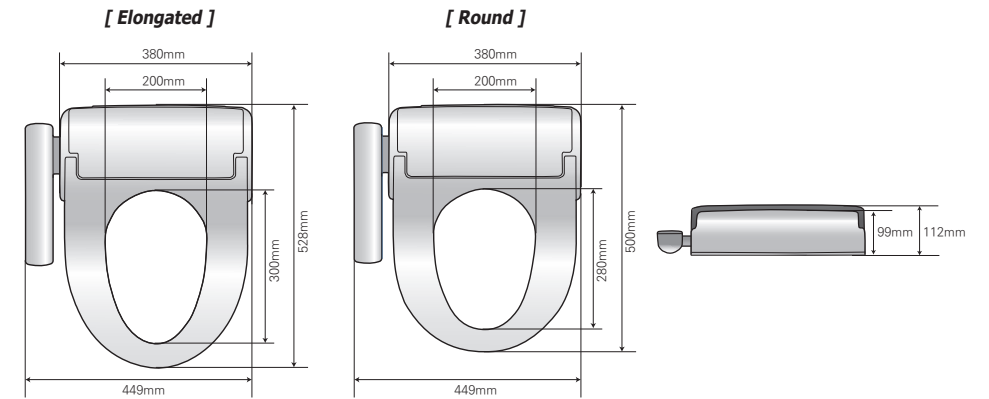

Remote model

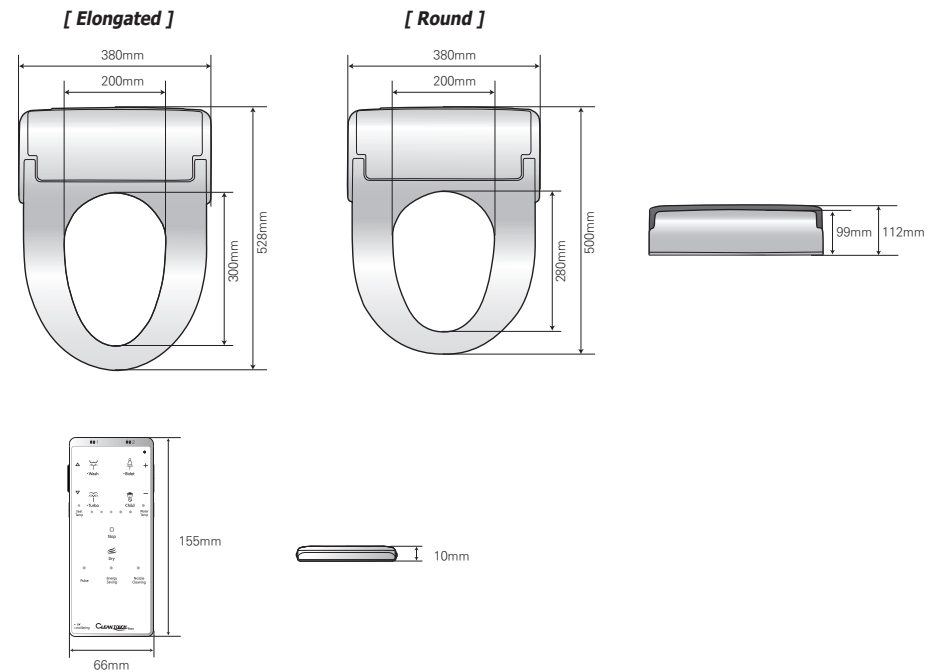

- WARRANTY -

Products are protected from internal hardware defects with a 2-year limited warranty. Sales receipt is proof of purchase. Warranty is limited to original purchaser and is not transferable. Repairs within warranty are covered for RETURN SHIPPING ONLY. Distributor is not responsible for the cost of removal, receiving, nor installing the bidet.

Product Name		Limited Warranty Period
Model Name		Two(2) years since the date of purchase
Date Purchased		
SER.No.		
Customer's Address	Name	
	Tel.No	

2 Year Limited Warranty:

- 100% Coverage of cost of all parts and labor for the entire product for the first year from original date of purchase
- 50% Coverage of cost of all parts and labor for the entire product for the second year from original date of purchase

Warranty Exclusions:

Within the warranty period, normal repair fees will still apply for the following warranty exception cases.

- damage or loss caused by improper use or maintenance, negligence, or abuse.
- damage or loss caused by improper installation, removal, repair, or modification
- damage or loss through natural disasters (flood, fire, electrical storm, etc.)
- damage or loss due to chemical, mineral, or sediment content in water system.

A water softener or filter is recommended in areas with strong mineral content in the water. Highly chlorinated water and chlorine cleaners can also damage this product.

- Physical damage, such as cracks, scratches, dents, etc.

Fraser International Trading Inc.
Unit 105-1772 Broadway St.
Port Coquitlam, BC, Canada V3C 2M8

Phone : 604-552-7711
Email : customerservice@fraserintl.com

