

General Instructions

For use with Dimplex baseboard heaters series BN, DBH and LC.

DTK-SP and DTKT-SP thermostat kit is design to work as freeze guard. It does not have a true “off” setting. When set to its lowest position, by counter clockwise rotation of the shaft to last stop, the thermostat cycles the heater on at approximately 4.4° C (40° F).

DTK-DP and DTKT-DP thermostat kits are design to have a positive “off”. The thermostat is in “off” position when the shaft is turned counter clockwise to last stop usually after a slight “click”. At this setting the heater will not cycle regardless of room temperature.

IMPORTANT INSTRUCTIONS

When using electrical appliances, basic precautions should always be followed to reduce the risk of fire, electric shock and injury to person, including the following:

1. Read all instructions before using this heater.

WARNING: To prevent electrical shock, disconnect from power sources before installing or servicing. Install in suitable enclosure. Keep free from contaminants.

SAVE THESE INSTRUCTIONS

Installation Instructions

WARNING: Wiring procedures and connections should be in accordance with the National Electric code (NEC) and local codes.

CAUTION: Disconnect electric power supply before working on circuit wiring to prevent electric shock.

The built-in thermostat may be installed either on the left or right hand end cap of the baseboard heater, through the rear or front entry of the baseboard terminal boxes.

1. **BN/DBH:** For installation through the rear entry (Figure 1) remove the cable clamp on the back of the baseboard. The baseboard lead wires are hooked to the back of the cable clamp for easy access.

For installation through the front entry (Figure 2) remove the front panel by pulling the top edge forward using hand protection and then lift off the terminal box cover after removing the retaining screw.

LC: For installation (Figure 3) remove the end panel (either end) by removing the securing screw.

2. Remove the three small knockouts from end cap using a screwdriver. (Figure 1/2/3).
3. Remove wire nut and separate the two baseboard leads (Figure 1/2/3).
4. Connect thermostat and baseboard leads to power supply wires as shown in Figure 5 for single pole or Figure 6 for double pole thermostat. Additional wire nuts are required.

Figure 1

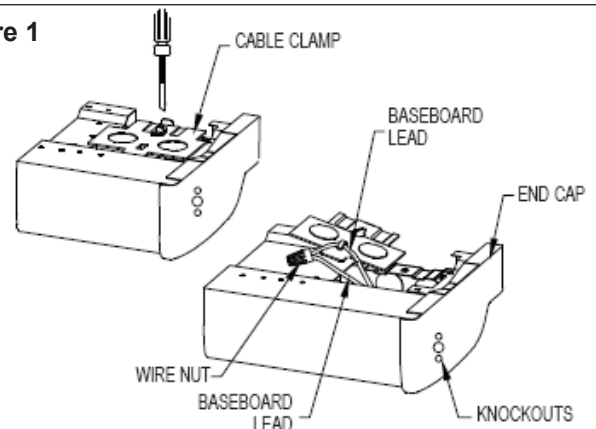

Figure 2

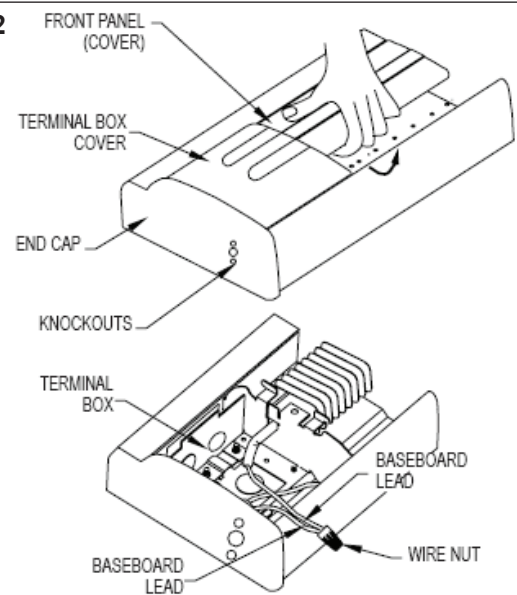
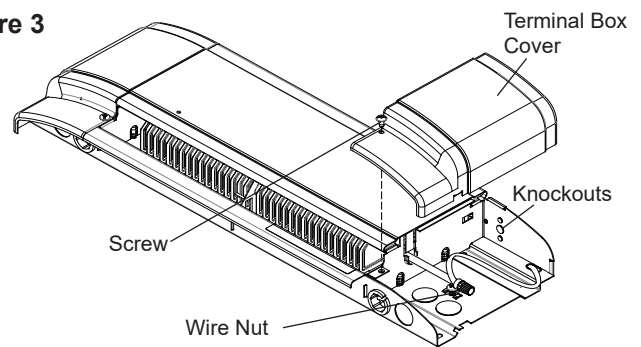

Figure 3



- NOTE:** For double pole thermostat installation read the marking on the back of the thermostat casing (Figure 4). Thermostat terminals are marked with ‘L1’, ‘OFF’, ‘L2’ and ‘CYCLE’. These same markings are referred to in the wiring diagrams on Figure 6.

5. Attach thermostat assembly to the end cap and fasten with the screws provided.

Figure 4

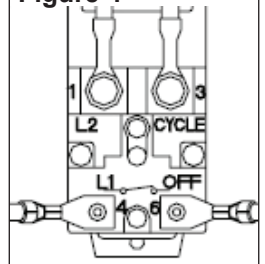

6. Remove all residual materials (knockouts or any other construction material).
7. Check that all electrical connections are tight and place all wiring inside the terminal box.
8. Replace the terminal box cover and front panel or the rear cable clamp. Care must be taken that no wires are pinched during installation.
9. Install knob (Figure 7) or plug button (Tamper proof version).
10. Follow the baseboard installation instructions to finish heater installation.

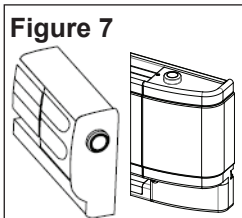

! IMPORTANT: DO NOT BYPASS OR ELIMINATE THERMAL CUTOUT FROM CIRCUIT. HANDLE THERMOSTAT WITH CARE.

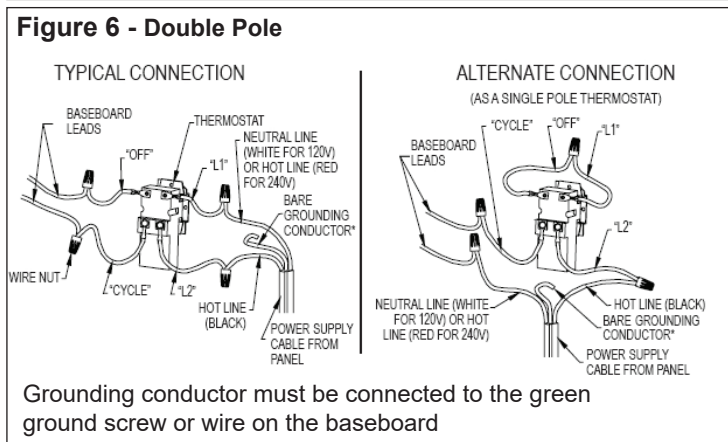
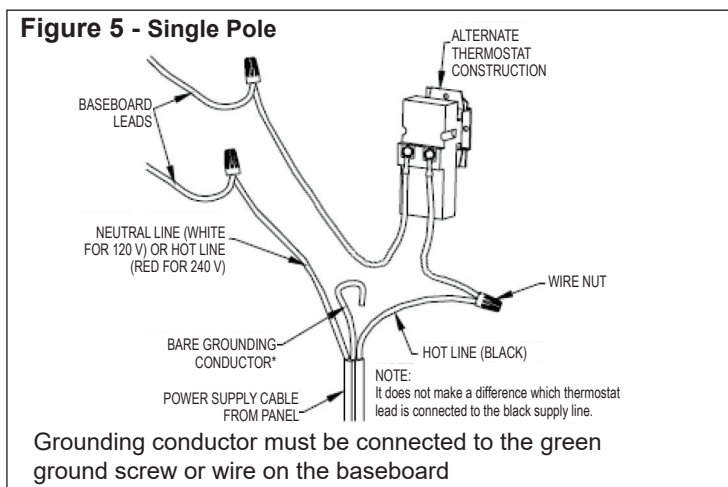

🔑 Operation

⚠ CAUTION: This thermostat must be properly installed before it is used.

The built-in thermostat senses the temperature of the air at the baseboard and must be set by trial to provide optimum room comfort. When first operating baseboard heater, turn thermostat knob clockwise to last stop. Within a short period of time the room will be at desired temperature. Turn the thermostat knob counter clockwise until baseboard goes off (you will hear a slight “click”). Keep thermostat knob at that setting and temperature will be automatically maintained.

🔧 Maintenance

⚠ CAUTION: Before removing the front cover for cleaning, make certain the power has been turned off at the circuit breaker panel.

⚠ CAUTION: Allow adequate time for the element and body casing to cool before attempting to work on the heater.

! NOTE: See heater manual for cleaning Instructions.

⚠ WARNING: The user can perform cleaning ONLY, all other servicing should be performed by qualified service personnel.



1-888-346-7539 | www.dimplex.com

In keeping with our policy of continuous product improvement, we reserve the right to make changes without notice.

© 2022 Glen Dimplex Americas

GlenDimplex
AMERICAS