

FLOATING CHAISE LOUNGE CHAIR

260 pounds
118 kg
Weight Capacity

2-PERSON
ASSEMBLY
RECOMMENDED

CAUTION

This product is not designed for use as a swing. Bouncing, swinging, or any other significant movement while in use may result in serious injury.

This product must be used on a level, stable surface. Make sure all hardware is securely tightened and all snap buttons are fully engaged before every use.

HELPFUL HINT

Sunnydaze advises reading this manual fully, and assembling the item soon after purchase. Check that all parts are accounted for and familiarize yourself with the assembly before beginning.

 **WARNING:** Failure to read and follow instructions and safety warnings could result in serious injury or damage to property.











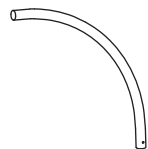

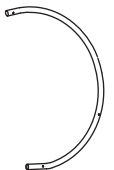



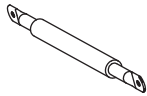
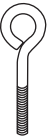

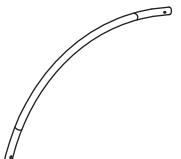

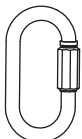
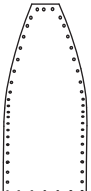
 **WARNING:** Manufacturer and seller expressly disclaim any and all liability from personal injury, property damage or loss, whether direct or indirect, or incidental, resulting from the incorrect attachment, improper use, inadequate maintenance, or neglect of this product.

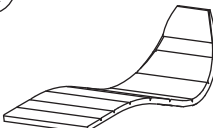
COMPONENTS



Inspect packaging to ensure all parts are accounted for before disposing of packing materials.

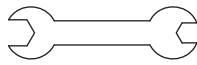

<p>A</p>  <p>Lower Support Pole Qty. 1</p>	<p>B</p>  <p>Upper Support Pole Qty. 1</p>	<p>C</p>  <p>Leg Qty. 4</p>	<p>D</p>  <p>Umbrella Frame Qty. 1</p>	<p>E</p>  <p>Left Seat Back Pole Qty. 1</p>
<p>F</p>  <p>Right Seat Back Pole Qty. 1</p>	<p>G</p>  <p>Right Seat Pole Qty. 1</p>	<p>H</p>  <p>Left Seat Pole Qty. 1</p>	<p>I</p>  <p>Front Seat Frame Qty. 1</p>	<p>J</p>  <p>Seat Frame Brace Qty. 1</p>
<p>AA</p>  <p>Eye Bolt Qty. 1</p>	<p>AB</p>  <p>Nut Set Qty. 1</p>	<p>M</p>  <p>Safety Bar Qty. 2</p>	<p>N</p>  <p>Closed S-Hook Qty. 1</p>	<p>O</p>  <p>Quick Link Qty. 1</p>
<p>P</p>  <p>Seat Web Qty. 1</p>	<p>Q</p>  <p>Rope Qty. 1</p>	<p>R</p>  <p>Chair Cushion Qty. 1</p>	<p>S</p>  <p>Umbrella Canopy Qty. 1</p>	<p>T</p>  <p>Threaded Knob Qty. 4</p>
<p>U</p>  <p>Foot Qty. 4</p>	<p>V</p>  <p>M8x95mm Bolt Qty. 1</p>	<p>W</p>  <p>M8x70mm Bolt Qty. 1</p>	<p>X</p>  <p>M8x35mm Bolt Qty. 4</p>	<p>Y</p>  <p>M8x15mm Bolt Qty. 2</p>
<p>Z</p>  <p>Hex Key Qty. 1</p>	<p>Z1</p>  <p>Spanner Qty. 1</p>	<p>! WARNING CHOKING HAZARD — This item contains small parts that can be swallowed by children. Keep children away during assembly.</p>		



ASSEMBLY

! Carefully read all assembly steps, care instructions, and safety information before using this product. !

Save these instructions for future reference.

Assemble components on a soft, clean surface to avoid scratching/damaging the finish.

When choosing a location for your floating lounger, select a smooth, level surface.

Select a location that is free of sharp objects, rocks or other debris that could be hazardous in case of a fall.

Do not install on dangerous terrain or objects such as slopes, on rocks, or in bodies of water.

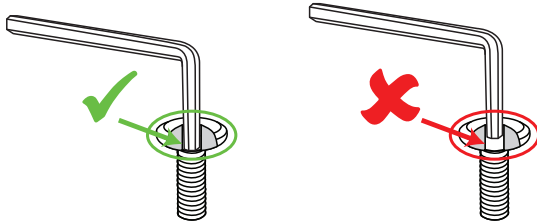

Tip: Always fully insert the hex key inside the designated notch of the bolt.

If the hex key is not fully inside the notch, the hex key could slip out, causing damage to the bolt head. Repeated hex key slipping will cause the notch to become rounded, making it difficult or impossible to tighten the bolt with the hex key.

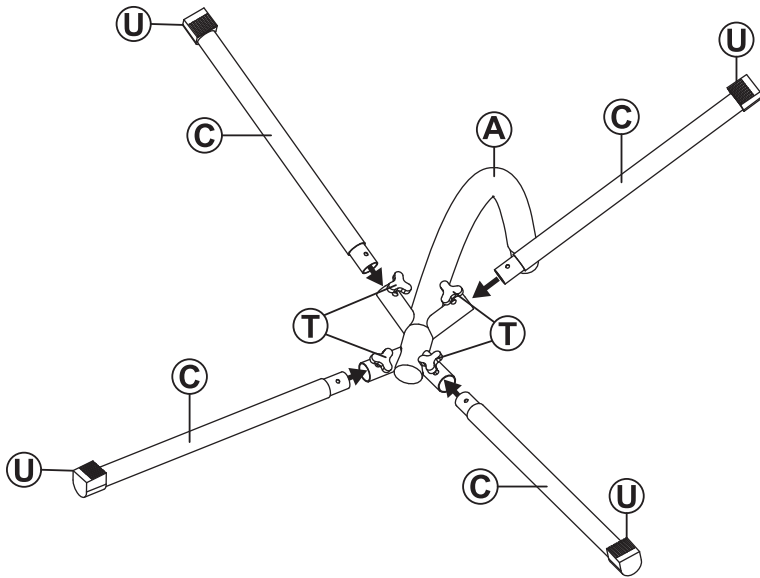

STEP 1

A: 1 C: 4 T: 4 U: 4

- Ensure Foot (U) is securely connected to the end of each Leg (C).
- Align the mounting holes in Legs (C) with the underside of Lower Support Pole (A) and secure using Threaded Knobs (T).
- Flip the assembled components upright so the feet are on the ground.

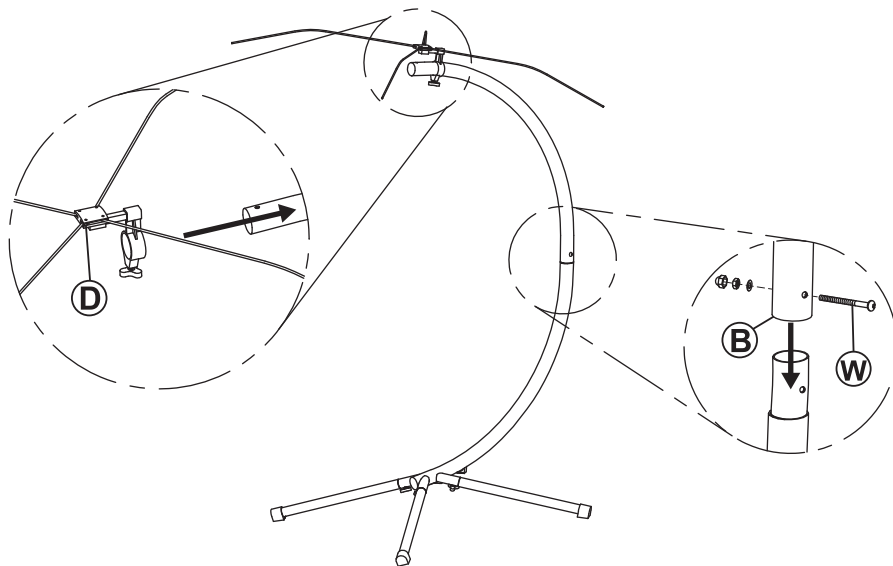

STEP 2

B: 1 D: 1 W: 1

- Place Upper Support Pole (B) onto the lower support pole. Align the mounting holes and secure using M8x70mm Bolt Set (W), as shown.
- Slide Umbrella Frame (D) onto the upper support pole. Ensure the umbrella frame is behind the mounting hole at the end of the upper support pole and secure to the umbrella frame.

NOTE: Avoid over-tightening the threaded knob on the umbrella frame as it may damage the finish of the stand.

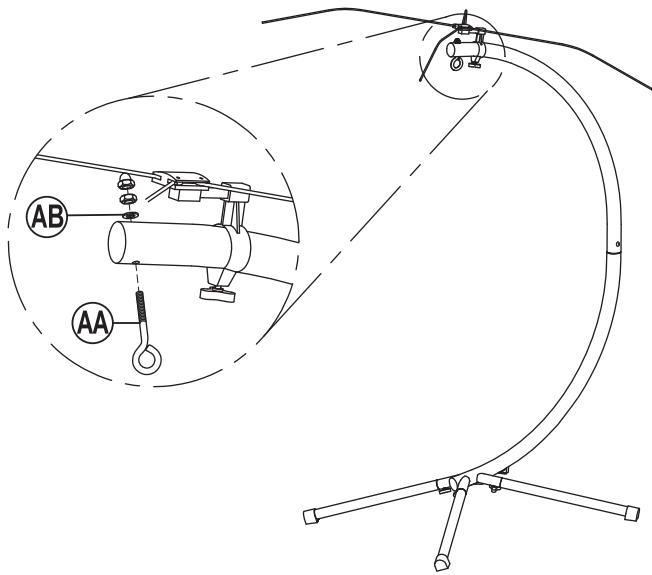

STEP 3

AA: 2 AB: 2

- Insert Eye Bolt (AA) through the underside of the mounting hole in the upper support pole and securely fasten it using Nut Set (AB), as shown.

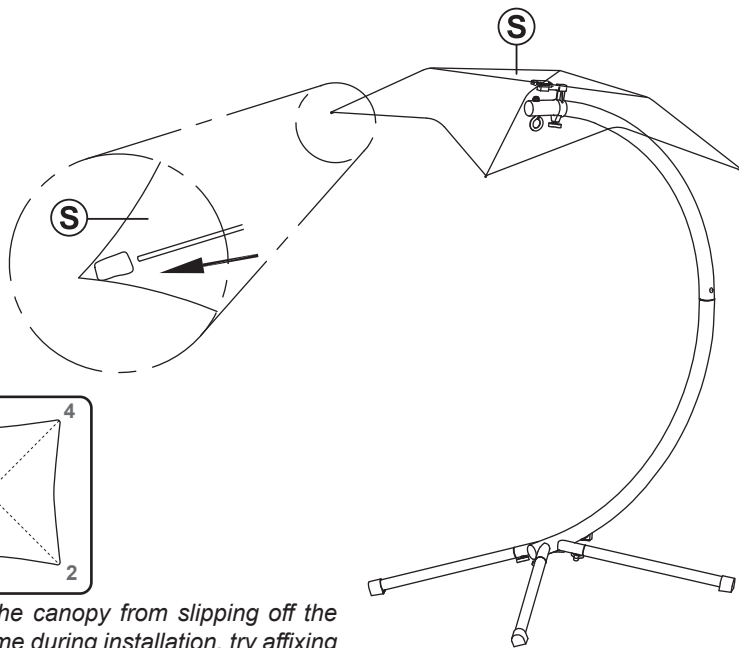

STEP 4

S: 1

- Evenly spread out the ribs on the umbrella frame.
- Place Umbrella Canopy (S) onto the umbrella frame.
- Slide the ribs into the plastic caps that are sewn into the ends of the umbrella canopy.

NOTE: Assistance may be required for this step. The canopy is intended to fit tightly. Some slight force may be required, but take care not to bend the ribs of the umbrella frame.

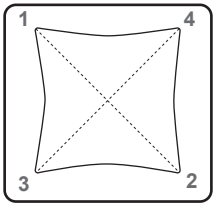

To prevent the canopy from slipping off the umbrella frame during installation, try affixing at opposing points, like shown.

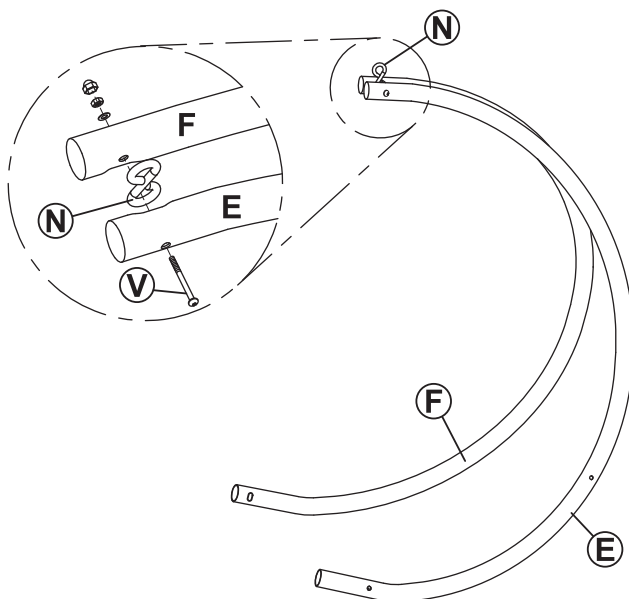

STEP 5

E: 1 F: 1 N: 1 V: 1

IMPORTANT: Identify the tops of Seat Back Poles (E & F); the tops will have a plug in the end.

Make sure the mounting holes to secure the safety bars are on the outsides of the poles.

- Place Closed S-Hook (N) between Left Seat Back Pole (E) and Right Seat Back Pole (F) and firmly secure components with M8x95mm Bolt Set (V), as shown.

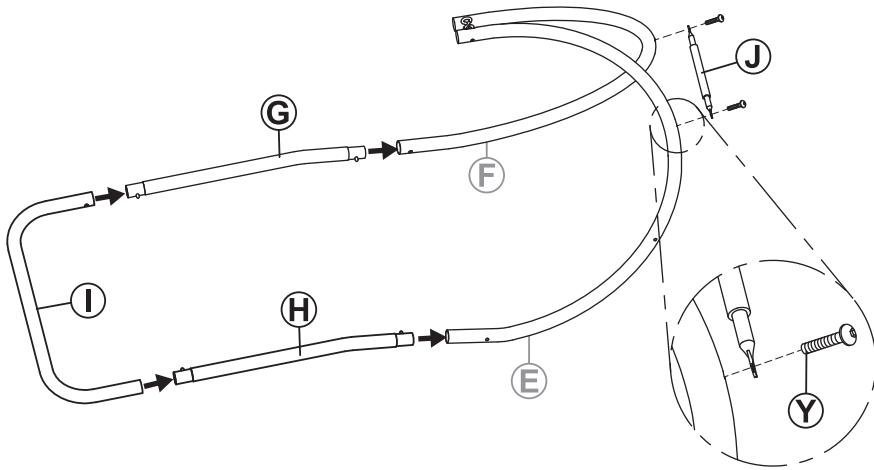

STEP 6

G: 1 H: 1 I: 1 J: 1 Y: 2

IMPORTANT: Identify the slight curves in Seat Poles (G & H); the straight end will install toward the foot of the lounger.

- Press the button spring clip on Right Seat Pole (G) and slide it into Right Seat Back (F), the button will snap into place.
- Press the button spring clip on Left Seat Pole (H) and slide it into Left Seat Back (E), the button will snap into place.
- Connect Front Seat Frame (I) to the seat poles.
- Attach Seat Frame Brace (J) to the backside of the seat poles using two M8x15mm Bolts (Y).

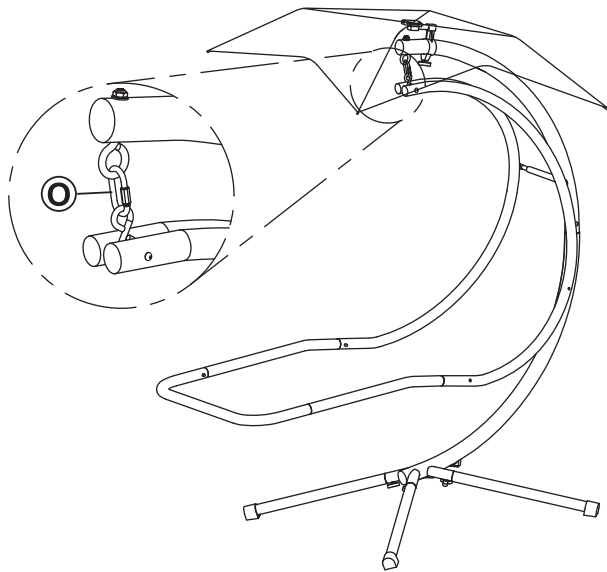

STEP 7

O: 1

- Unscrew the nut on Quick Link (O) and hang the link on Eye Bolt (AA).
- Hang the assembled chair frame on the quick link and screw the nut closed, ensuring it is tightly fastened.

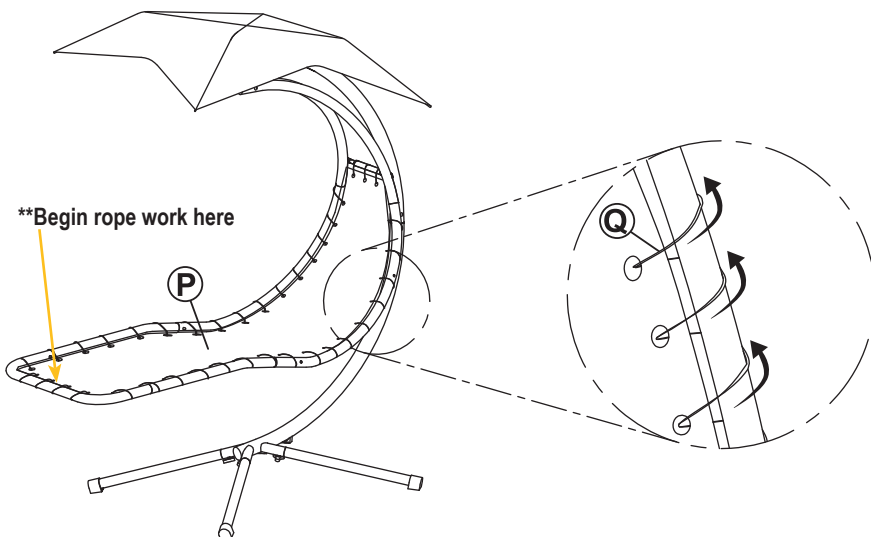

STEP 8

P: 1 Q: 1

- Unravel Rope (Q) and fold in half to identify the center-most point of the rope.
- ****Beginning at the center of the front seat frame, attach Seat Web (P) to the floating chair by running Rope (Q) through the grommets in the seat web and around the chair frame.**

Tips: To help keep the rope length even on both sides during threading, switch between the left and right side every few eyelets OR tie a knot.

After initial installation of the seat webbing, start back at the footrest and pull the rope every few eyelets to ensure the seat webbing remains taut.

- Once seat web is taut, wrap excess rope to the chair frame, above the frame brace, leaving enough rope to tie/knot the ends.

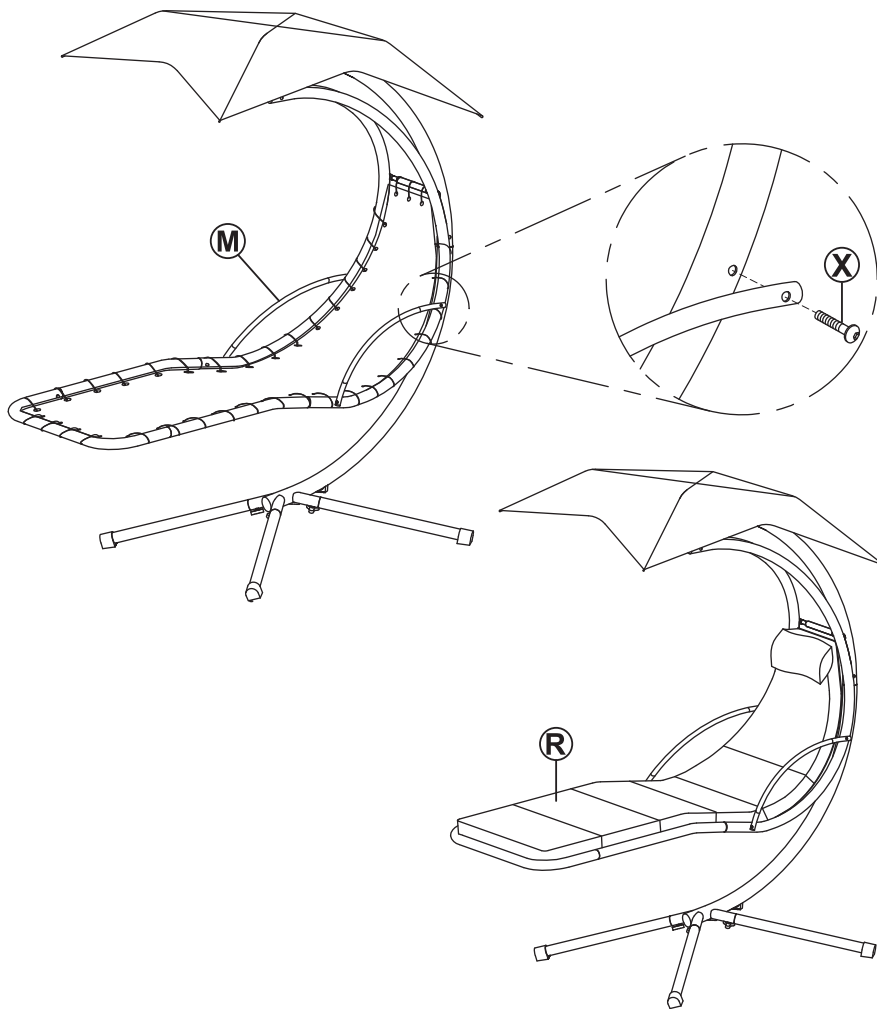

STEP 9

M: 2 X: 4

- Align Safety Bar (M) with the mounting holes on the outside of chair.
- Loosely connect the top of Safety Bar (M) to the floating chair using one M8x35mm Bolt (X), as shown.
- Fasten the bottom of the safety bar to the chair using one M8x35mm Bolt (X).
- Repeat this step to connect the remaining safety bar to the opposite side of the chair.

STEP 10

R: 1

- Tie Chair Cushion (R) onto the chair.

BEFORE USE

This product is only to be used by adults and person(s) with developed motor skills who understand the potential dangers if it is misused.

IMPORTANT: The lounge chair hangs freely and the height may not be suited for all users. Ensure all users carefully read and understand how to safely enter and exit the chair before using this product. If user cannot enter or exit the chair as explained in the 'HOW TO USE' section (page 7), it is important that another person help by holding the chair steady while the user enters and exits the chair.

- Ensure all hardware is securely fastened.
- Ensure the stand is on a firm, flat, and level surface.
- Carefully read all use, care, and safety information to ensure the stand is used safely.
- Always enter and exit the chair slowly.
- Do not swing in the chair!

⚠️ WARNING:

Manufacturer and seller expressly disclaim any and all liability from personal injury, property damage or loss, whether direct or indirect, or incidental, resulting from the incorrect attachment, improper use, inadequate maintenance, or neglect of this product.

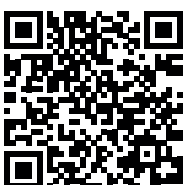

LEARN MORE ABOUT HAMMOCK SAFETY!

SCAN THE CODE WITH YOUR SMARTPHONE

OR VISIT

<https://tiny.cc/hammock-safety>

HOW TO USE

! BEFORE USE: Carefully read all use, care, and safety information to ensure this product is used safely.



Take your time getting in and out of your floating lounge chair.
If user cannot safely enter and exit the chair on their own, assistance is required.



1 With your backside toward the lounge chair and feet flat on the ground, firmly grip the safety bar and chair frame. Slowly begin lowering yourself into the seat.



2 Keeping both feet flat on the ground, wait for the chair to stop moving. Release the hand holding the frame and grip the opposite side of the chair — grip the safety bar or frame, whichever is most comfortable for you. Slowly and carefully scoot yourself toward the center of the chair.



3 Keeping one foot flat on the ground, very slowly lift one leg into the chair.
If the chair begins to move too far for safe entry, position your feet back on the ground and start again.



4 Lift your other foot off the ground and use the safety bars to pivot your body into the center of the chair. Use the safety bars for leverage when repositioning.



5 Once you have found a comfortable position, release the safety bars and relax.



6 To exit the chair, simply sit up, grip the safety bars firmly, and slowly swing your legs over the edge of the chair. Place both feet flat on the ground, grip the safety bar and frame, then slowly stand up.

GENERAL USE & CARE



WARNING: Do not use if parts are missing, worn, or damaged.



WARNING: Do not use this product as or like a swing.



WARNING: Do not allow children to use this product without constant adult supervision.



WARNING: Always keep weight centered in the chair when using this product.

SAFE USE: Follow all safety statements and warnings. Always move slowly when getting in and out of the chair. Do not use this chair for swinging. Swinging, bouncing, jumping, and other excessive movements may result in the user falling out or the stand to tip over, which may result in serious injury or property damage.

Always remove the cushion and umbrella canopy when not in use.

CHILDREN: This product is only to be used by adults and person(s) with developed motor skills who also understand the potential dangers if this product is misused.

Supervise children at all times. Never allow small or young children to enter or exit this chair without adult assistance. Never allow or encourage children to sleep or play in the floating lounge chair. Always teach and practice safe use.

INSPECTION: Ensure the unit is assembled correctly and all hardware is securely tightened before every use.

Do not use this product if parts are missing, broken, damaged, or worn out.

COVER AND STORE: Always remove the cushion and umbrella canopy when chair is not in use. Protect the frame and chair from damages caused by sunlight and water by covering or storing it when not in use. Avoid long-term exposure to precipitation and high-moisture areas. Store in a cool, dry location.

SUN EXPOSURE: All fabrics will eventually fade from sun exposure. Maintain fabric color and integrity by storing the cushion and umbrella canopy indoors when not in use.

CLEANING: Use a soft cloth and warm water to wipe down the unit. Spot-clean the cushion and canopy. Dry the stand after cleaning to prevent rust. Do not use chemicals or abrasive materials to clean any part of the unit.

SCRATCHES: The powder coating on the stand is tough and durable, but even under normal use, some scratching is inevitable. To avoid rust, wipe scratched areas as needed to remove moisture.

TROUBLESHOOTING

THE STAND SEEMS UNSTABLE.

If you are unfamiliar with using a floating lounge chair, it can leave you feeling uneasy; take some time to get used to it. Always enter and exit the chair slowly. Swinging or aggressive movement may result in the user falling out of the chair.

- Make sure the stand is on a flat, level surface. Softer surfaces, such as grass, may cause the stand to sit unevenly.
- Ensure all components are assembled correctly, and the hardware is securely fastened.



SAFETY STATEMENTS & WARNINGS



- Do not exceed the weight limit: 260 pounds
- This product is intended to be used by one person at a time.
- Use caution when sitting in the chair. Enter and exit the chair near the safety bar only, with your feet firmly on the ground. NEVER use a stool or any other object to enter or exit the chair.
- Do not swing, bounce, jump, twist, or spin in the chair.
- Install all parts in accordance with the assembly instructions and inspect the stand before use.
- Ensure all hardware is securely installed and tightened before each use.
- Always inspect the chair, stand and hardware for damage before each use.
- Do not allow children to use this product without constant adult supervision. This floating lounge chair is NOT A SWING.

Any modification to the product or failure to follow recommended care will void the product warranty.

WARNING:

Manufacturer and seller expressly disclaim any and all liability from personal injury, property damage or loss, whether direct or indirect, or incidental, resulting from the incorrect attachment, improper use, inadequate maintenance, or neglect of this product.