

Item Number: A02251

WARNING (To reduce the risk of fire, electric shock, or personal injury):

1. We suggest installation by a **licensed electrician**.
2. Please read the instruction carefully and save it as you may need it at a later time.
3. Before you start, **NEVER** attempt any work without shutting off the electricity until the work is done.
 - A) Go to the main fuse, or circuit breaker, box in your home. Place the main power switch in the “**OFF**” position.
 - B) Place the wall switch in the “**OFF**” position.
4. Mounting surface should be clean, dry, flat, strong enough and 1/4” larger than the canopy on all sides. Any gaps between the mounting surface and canopy exceeding 3/16” should be corrected as required.
5. Make sure that the ceiling or wall can stand the weight of the lamp before installation.
6. Make sure the voltage you are using is **120V**. The maximum wattage is **60W** per bulb.
7. Keep the lamp away from acidic and alkaline substances in case of damaging the surface of the lamp.
8. When replacing bulbs, you should turn off or unplug the lamp and you must wait until it is cool as bulbs get hot quickly.
9. The safety instructions appearing in this manual are not meant to cover all possible conditions that may occur. It must be understood that common sense, caution and care must be used with any electrical products.

IMAGE FOR FINISHED PRODUCT:

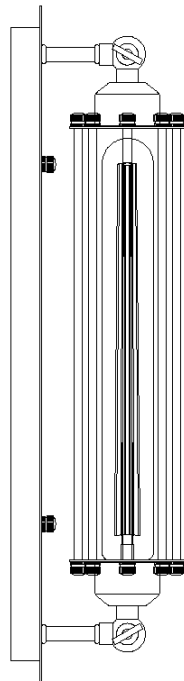

TOOLS REQUIRED (NOT INCLUDED):

Before starting assembly and installation please prepare the needed tools as below picture

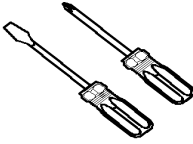
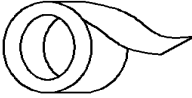
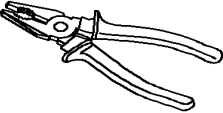
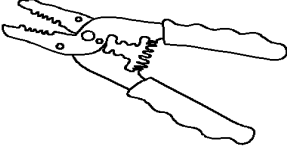
				
Ladder	Phillips head.flat blade screwdriver	Electrical tape	Pliers	Wire cutter/Stripper

PARTS INCLUDING:

- (A) Mounting plate (1)
- (C) Back plate (1)
- (D) Ball nut (2)
- (E) Joint (2)
- (F) Socket ring (2)
- (G) Green ground screw (1)
- (I) Socket cap (2)
- (J) Cage (1)

ACCESSORIES ENCLOSED:

- (B) Mounting screw (2)
- (H) Plastic wire connector (3)

WALL & OUTLET BOX

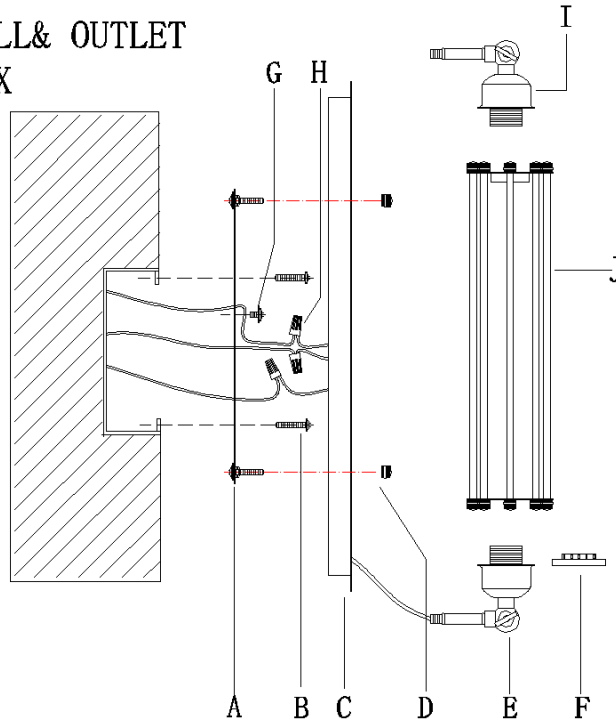

ASSEMBLY & INSTALLATION INSTRUCTIONS:

1. Carefully remove the fixture from the carton and check that all parts and accessories are included as shown in the above illustration.
2. Make bulb installation

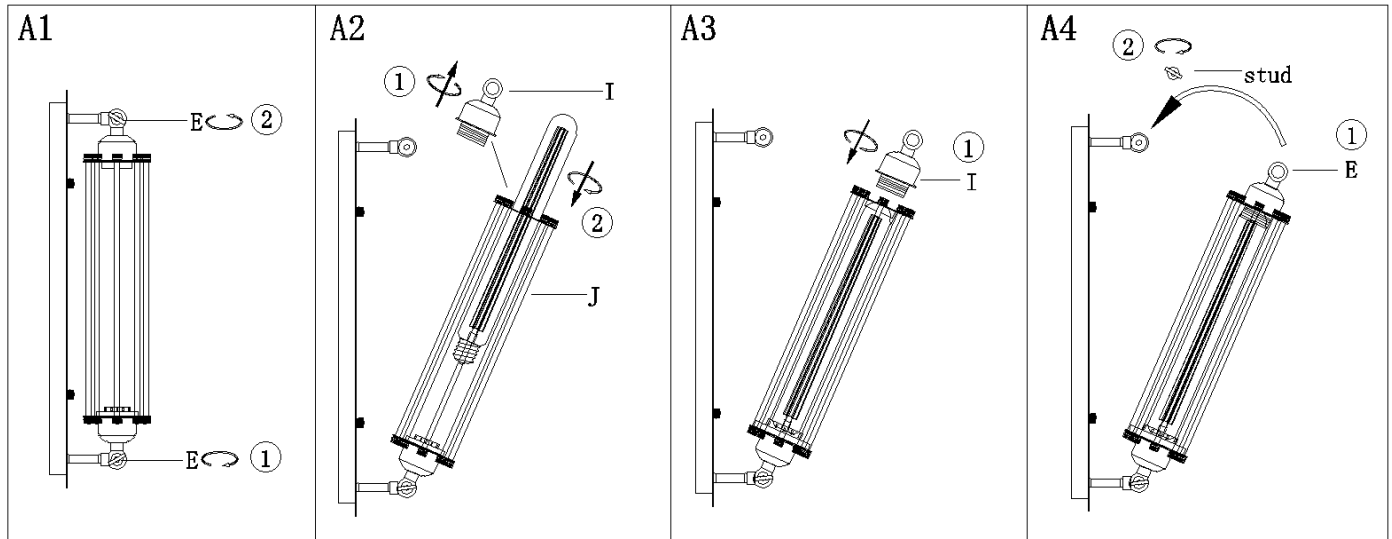

Step A1: Slightly loosen the stud in lower joint (E) and allow it to rotate a little bit.

Unscrew and remove the stud from upper joint (E) .

Step A2: Unscrew upper socket cap (I) from cage (J).

Install the bulb (Not included. Please do not exceed the maximum wattage recommended on the socket.)

Pass the bulb through cage (J) and then install it onto the socket.

Step A3: Tighten upper socket cap (I) to cage (J).

Step A4: Secure upper joint (E) onto back plate (C) with the previously removed stud and check every step is assembled properly.

3. Turn off power

Before you start the installation, NEVER attempt any work without shutting off the electricity until the work is done.

A) Go to the main fuse, or circuit breaker, box in your home. Place the main power switch in the “OFF” position.

B) Place the wall switch in the “OFF” position.

4. Make installation

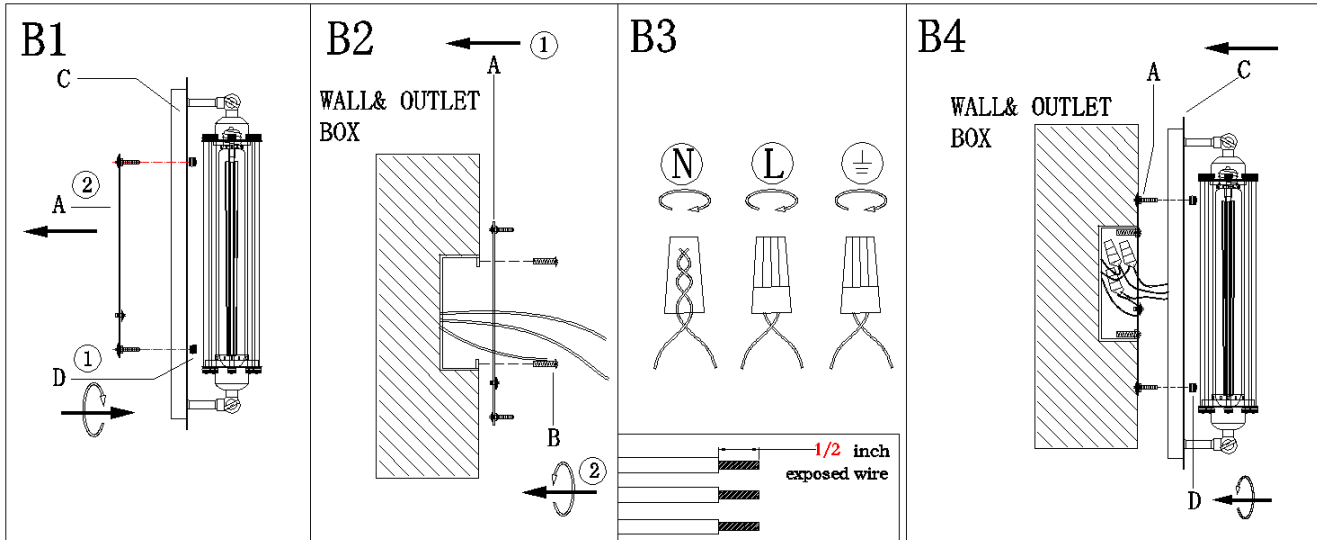

Step B1: Unscrew ball nuts (D) from back plate (C) then gently remove mounting plate (A).

Step B2: Attach mounting plate (A) to the outlet box with mounting screws (B).

Step B3: Make wire connections

Connect wires as below wires connection shown. **PLEASE NOTE THAT GROUND WIRE IS BARE COPPER WIRE, NEVER CONNECT OTHER WIRES TO GROUND WIRES.**

Connect ground wires according to the below chart

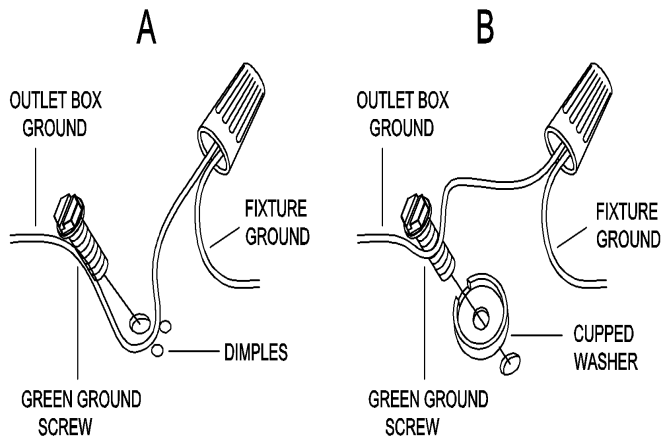

Connect wires according to the below chart

Connect Black or Red Supply Wire to:	Connect White Supply Wire to:
Black	White
*Parallel cord (round & smooth)	*Parallel cord (square & ridged)
Clear, Brown, Gold or Black without tracer	Clear, Brown, Gold or Black with tracer
Insulated wire (other than green) with copper conductor	Insulated wire (other than green) with silver conductor

*Note: When parallel wires (SPT I & SPT II) are used. The neutral wire is square shaped or ridged and the other wire will be round in shape or smooth (see illus.)

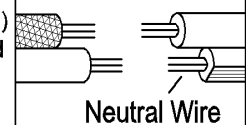

Twist wires together with plastic wire connectors until tightly joined, and wrap each connector with approved electrical tape. Be sure that no wire strands are exposed and then carefully tuck all wires into the outlet box.

Step B4: Align back plate (C) with the pre-assembled screws on mounting plate (A) and secure them with ball nuts (D).

5. Check everything is installed properly, then you could turn on the light. Enjoy!

CLEANING

To clean, wipe the fixture with a soft cloth. Do not use abrasive materials such as scouring pads or powders, steel wool or abrasive paper.

ORDERING PARTS

Keep this sheet for future reference in case you need to order replacement parts. All parts for this fixture can be ordered from the place of purchase. Be sure to use exact wording from illustration when ordering parts.