



Item Number: A03696

WARNING (To reduce the risk of fire, electric shock, or injury to persons):



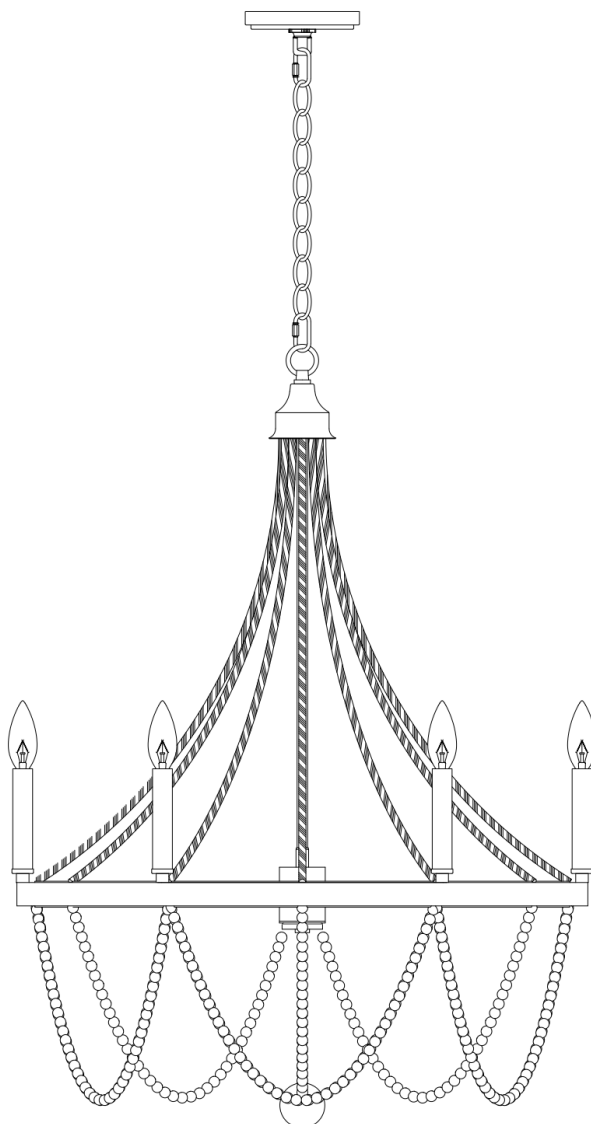

1. We suggest installation by a **licensed electrician**.
2. Please read the instruction carefully and save it as you may need it at later time.
3. Before you start, **NEVER** attempt any work without shutting off the electricity until the work is done. A). Go to the main fuse, or circuit breaker, box in your home. Place the main power switch in the **"OFF"** position. B). Place the wall switch in the **"OFF"** position.
4. Mounting surface should be clean, dry, flat, strong enough and 1/4" larger than the canopy on all side. Any gaps between the mounting surface and canopy exceeding 3/16" should be corrected as required.
5. Make sure that the ceiling or wall can stand the weight of the lamp before fixture.
6. Make sure the voltage you are using is **120V**. The maximum wattage is **40W** per bulb.
7. Keep the lamp away from acidic and basic objects in case of damaging the surface of the lamp.
8. When replacing bulb, you should turn off or unplug the lamp and you must wait until it is cool as bulbs get hot quickly.
9. The safety instructions appearing in this manual are not meant to cover all possible conditions that may occur. It must be understood that common sense, caution and care must be used with any electrical products.

IMAGE FOR FINISHED PRODUCT:

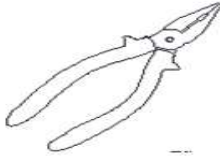

TOOLS REQUIRED (NOT INCLUDED):

Before doing assembly and installation please prepare the needed tools as below picture

| | | | | |
|---|---|---|--|---|
|  |  |  |  |  |
| Ladder | Phillips head, flat blade screwdriver | Electrical tape | Pliers | Wire cutter/Stripper |

PARTS TYPE & QTY INCLUDING:

- (A) Hex nut (1)
- (C) Nipple (1)
- (E) Single bar (1)
- (F) Green ground screw (1)
- (G) Canopy (1)
- (H) Collar ring (1)
- (I) Collar loop (1)
- (J) Quick link (2)
- (K) Chain (1)
- (L) Loop (1)
- (M) Tube (1)
- (N) Hemp rope (6)
- (O) Iron pipe (6)
- (P) Steering joint (6)
- (Q) Fixture body (1)
- (R) Bead chain (12)
- (S) Bead chain (1)

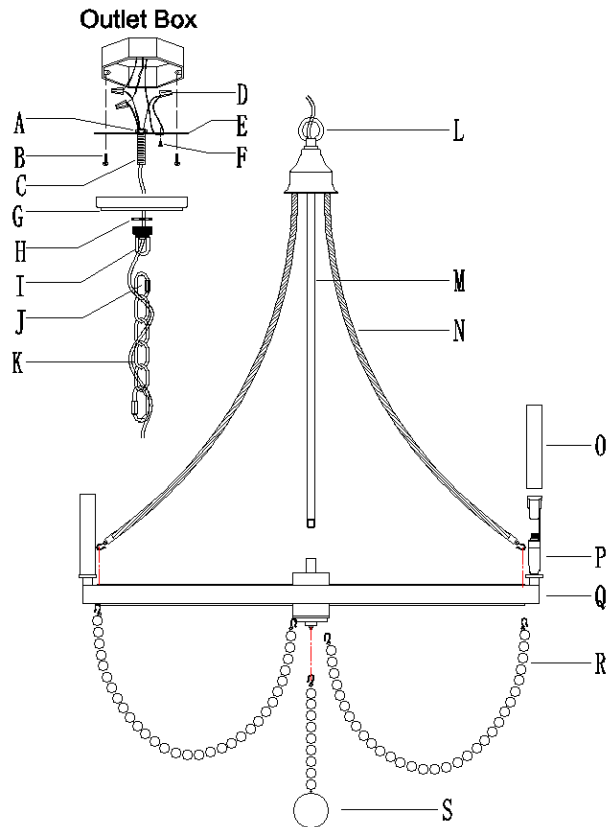

ACCESSORIES & QTY ENCLOSED:

- (B) Mounting screw (2)
- (D) Plastic wire connector (3)

ASSEMBLY & INSTALLATION INSTRUCTIONS:

1. Carefully remove the fixture from the carton and check that all parts and accessories are included as shown in the above illustration.
2. Make assembly

If the group of parts are not already assembled:

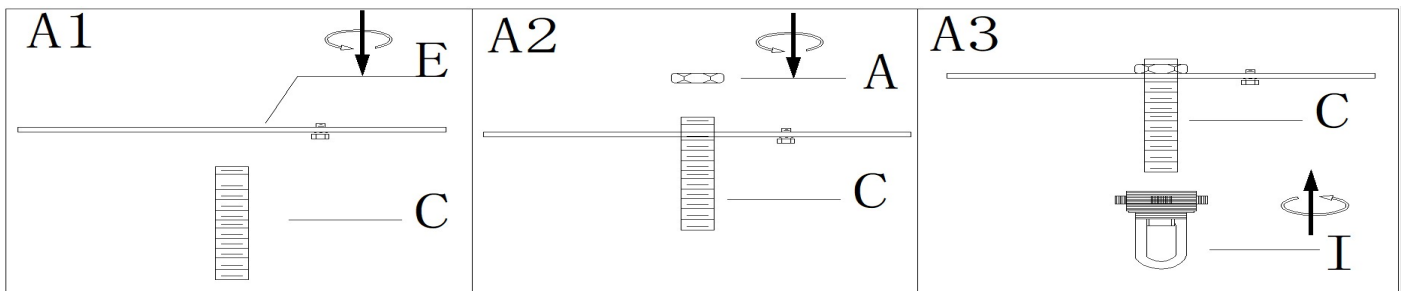

Step A1: Thread the single bar(E) onto nipple (C),

Step A2: Thread the hex nut (A) onto the nipple (C) till snug. At this point need note that: the side of single bar marked "GND"

must face to the down.

Step A3: Thread the collar loop (I) onto the nipple (C)

3. Make pre-installation

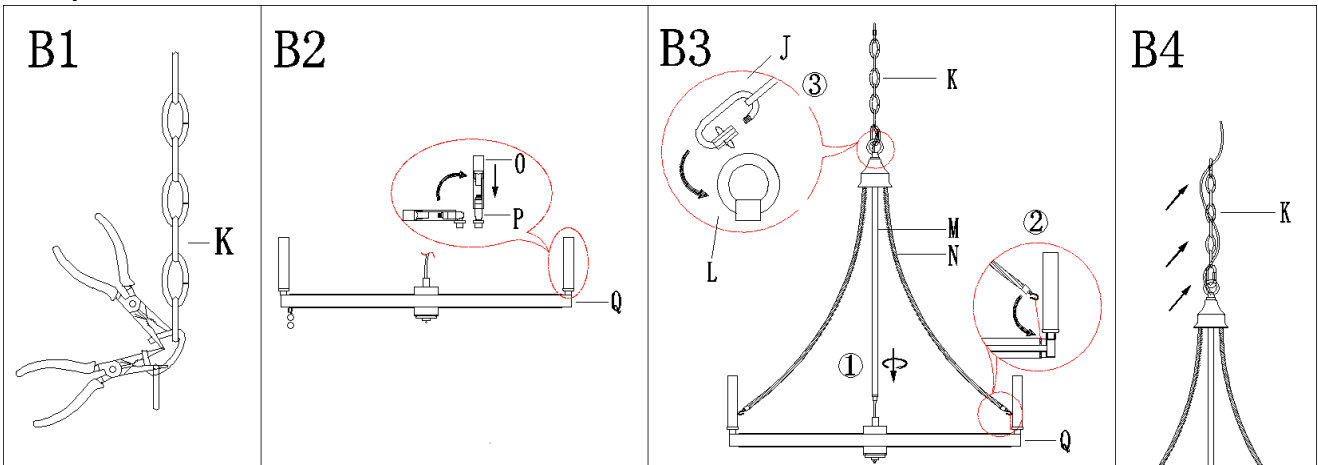

Step B1: By measuring, determine the correct number of links needed for proper hanging height. Using the chain pliers, disconnect and discard the remaining chain.

Step B2: Adjust the steering joint to the vertical direction. Then push the tube down to the bottom of the steering joint

Step B3: Thread the tube (M) onto the threaded nipple of fixture body (Q) till tighten .

Hang the bead chains (N) onto the rings of fixture body (Q).

Attach the quick link (J) to connect the chain (K) on the loop (L), Gently pull the wires till snug .

Step B4: Carefully lace the wires through the chain (K) (every other link) and stop just before you reach the top of chain (K).

4. Turn off power

Before you start to make installation, NEVER attempt any work without shutting off the electricity until the work is done.

A). Go to the main fuse, or circuit breaker, box in your home. Place the main power switch in the "OFF" position. B). Place the wall switch in the "OFF" position

5. Make installation

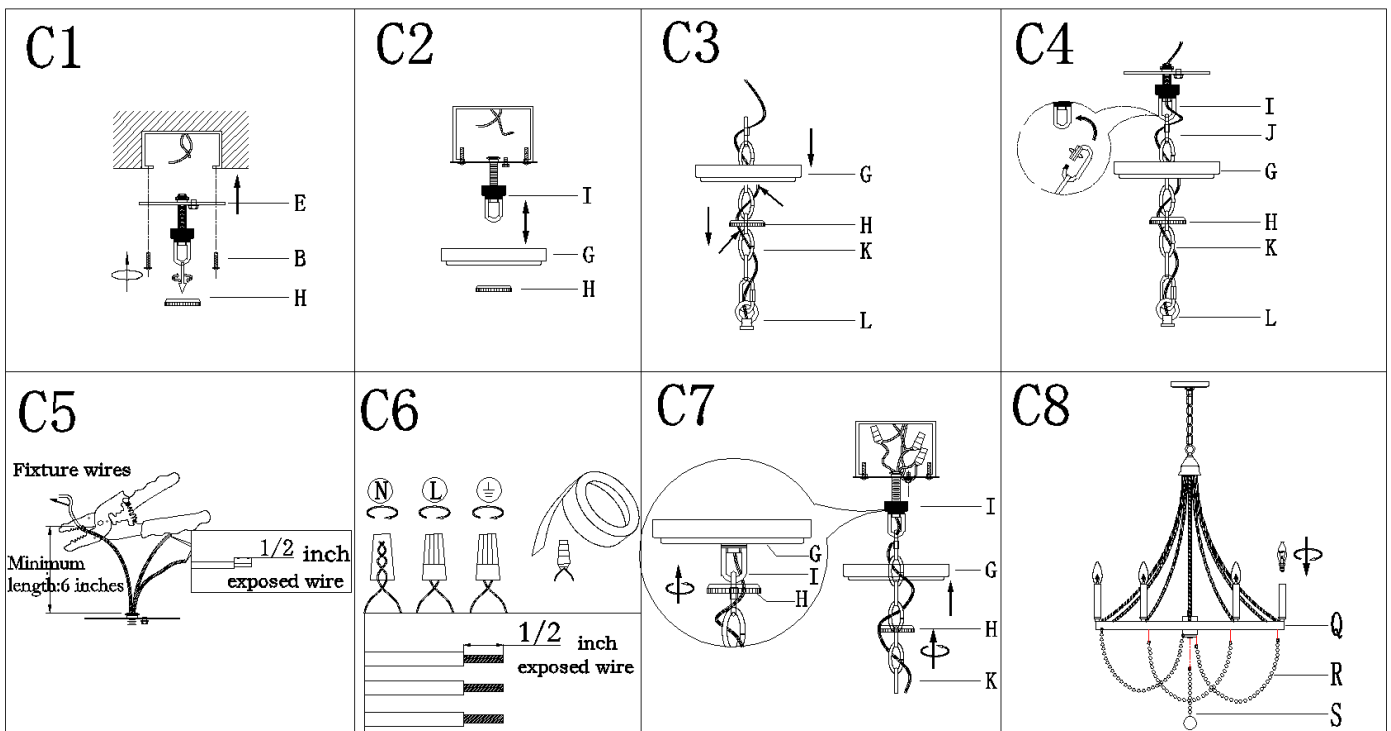

Step C1: Attach the single bar (E) to outlet box with mounting screws (B). The side of single bar marked "GND" must face out

Step C2: Raise the canopy (G) through screw collar loop (I) and screw the collar loop (I) to a proper position by measuring. Unscrew threaded ring (H) from screw collar loop (I) and remove the canopy (G). In this way, you would know the Proper position on which collar loop it should be located.

Note: The canopy (G) should be snug against the ceiling and the collar loop (I) should be screwed enough threads (no less than 6 threads)over the threaded nipple (C) for more secure hanging .If not, adjust the collar loop (H)on the single bar assembly by screwing the collar loop (I) in or out of the single bar (E) until the length is achieved.

Step C3: Slip the threaded ring(H) over the chain(K),then do the same with the canopy(G)

Step C4: Open the quick link(J), attach the quick link (J) to connect the loop (I). Close the quick link(J)

Pass the wires through screw collar loop(H) to the top of nipple(E) and gently pull till snug.

Step C5: If needed, cut off the wires length of fixture.At this point, the remaining wire length measured from the top of single bar(B) is at least 6".

Step C6: Make wire connections

Connect wires as below wires connecting shown. **TAKE NOTE OF YOUR COLOR OF FIXTURE ,NEVER CONNECT WIRES TO GROUND WIRES**

Connect ground wire according to below chart

Connect wires according to below chart

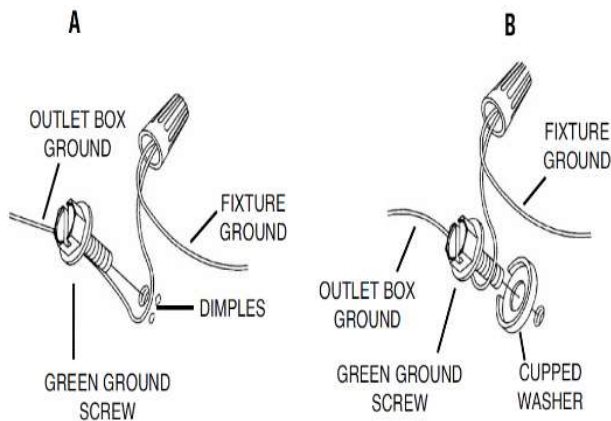

| Connect Black or Red Supply Wire to: | Connect White Supply Wire to: |
|---|---|
| Black | White |
| *Parallel cord (round & smooth) | *Parallel cord (square & ridged) |
| Clear, Brown, Gold or Black without tracer | Clear, Brown, Gold or Black with tracer |
| Insulated wire (other than green) with copper conductor | Insulated wire (other than green) with silver conductor |

*Note: When parallel wires (SPT I & SPT II) are used. The neutral wire is square shaped or ridged and the other wire will be round in shape or smooth (see illus.)

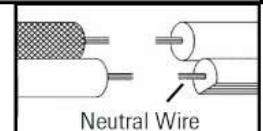

Twist plastic wire connector(D) until wires are tightly joined together,wrap each connector with approved electrical tape for more secure connection, then carefully stuff all wires into the outlet box

Step C7: Raise canopy (G) to ceiling and secure canopy (G) in place by tightening threaded ring (H) onto collar loop (I)

Step C8: String the bead chain(R) and bead chain (S) curtain through the fixture body (Q).

Install bulbs (not included) (Please do not exceed the maximum capacity recommended on the socket.)

6. Check everything is already installed properly, then you could turn on the light. Enjoy !

CLEANING

To clean, wipe fixture with a soft cloth. Do not use abrasive materials such as scouring pads or powders, steel wool or abrasive paper.

ORDERING PARTS

Keep this sheet for future reference, and in case you need to order replacement parts. All parts for this fixture can be ordered from place of purchase. Be sure to use exact wording from illustration when ordering parts.