

Item Number: A04123

WARNING (To reduce the risk of fire, electric shock, or personal injury):

1. We suggest installation by a **licensed electrician**.
2. Please read the instruction carefully and save it as you may need it at later time.
3. Before you start, **NEVER** attempt any work without shutting off the electricity until the work is done.
 - A) Go to the main fuse, or circuit breaker, box in your home. Place the main power switch in the **"OFF"** position.
 - B) Place the wall switch in the **"OFF"** position.
4. Mounting surface should be clean, dry, flat, strong enough and 1/4" larger than the canopy on all side. Any gaps between the mounting surface and canopy exceeding 3/16" should be corrected as required.
5. Make sure that the ceiling or wall can stand the weight of the lamp before installation.
6. Make sure the voltage you are using is **120V**. The maximum wattage is **Type A, Max 60W** per bulb.
7. Keep the lamp away from acidic and alkaline substances in case of damaging the surface of the lamp.
8. When replacing bulb, you should turn off or unplug the lamp and you must wait until it is cool as bulbs get hot quickly.
9. The safety instructions appearing in this manual are not meant to cover all possible conditions that may occur. It must be understood that common sense, caution and care must be used with any electrical products.

IMAGE FOR FINISHED PRODUCT:

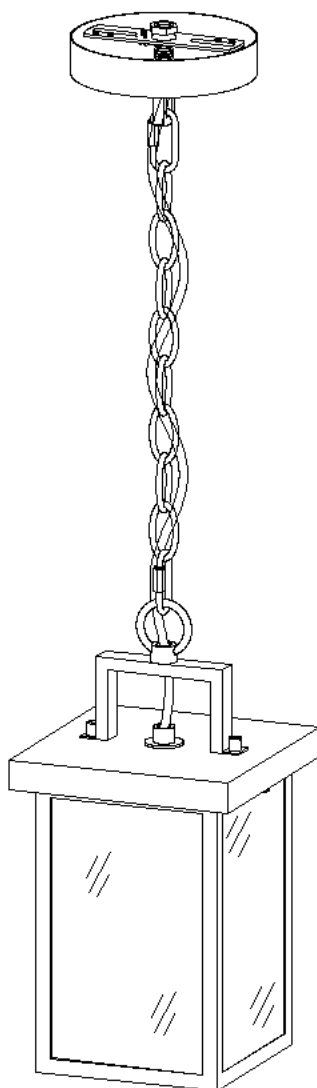

TOOLS REQUIRED (NOT INCLUDED):

Before starting assembly and installation please prepare the needed tools as below picture

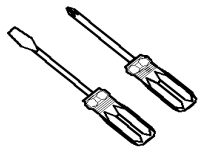
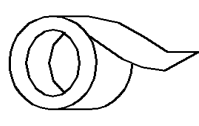
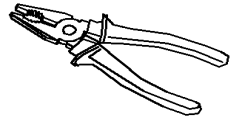
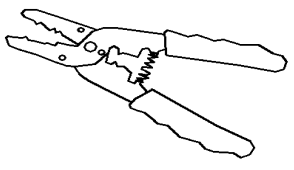
				
Ladder	Phillips head flat blade screwdriver	Electrical tape	Pliers	Wire cutter/Stripper

PARTS TYPE & QTY INCLUDING:

- (C) Single bar (1)
- (D) Green ground screw (1)
- (E) Canopy (1)
- (F) Collar ring (1)
- (G) Collar loop (1)
- (H) Quick link (2)
- (I) Chain (1)
- (J) Loop(1)
- (K) Knob nut (4)
- (L) Plastic washer (4)
- (M) Square tube frame (1)
- (N) Cover (1)
- (O) Screw (6)
- (P) Glass plate (4)
- (Q) Iron frame (1)
- (R) Iron piece (4)

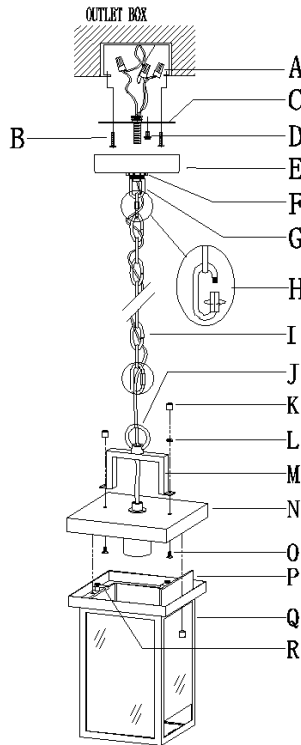

ACCESSORIES & QTY ENCLOSED:

- (A) Wire connector (3)
- (B) Mounting screw (2)

ASSEMBLY & INSTALLATION INSTRUCTIONS:

1. Carefully remove the fixture from the carton and check that all parts and accessories are included as shown in the above illustration.
2. Make pre-installation

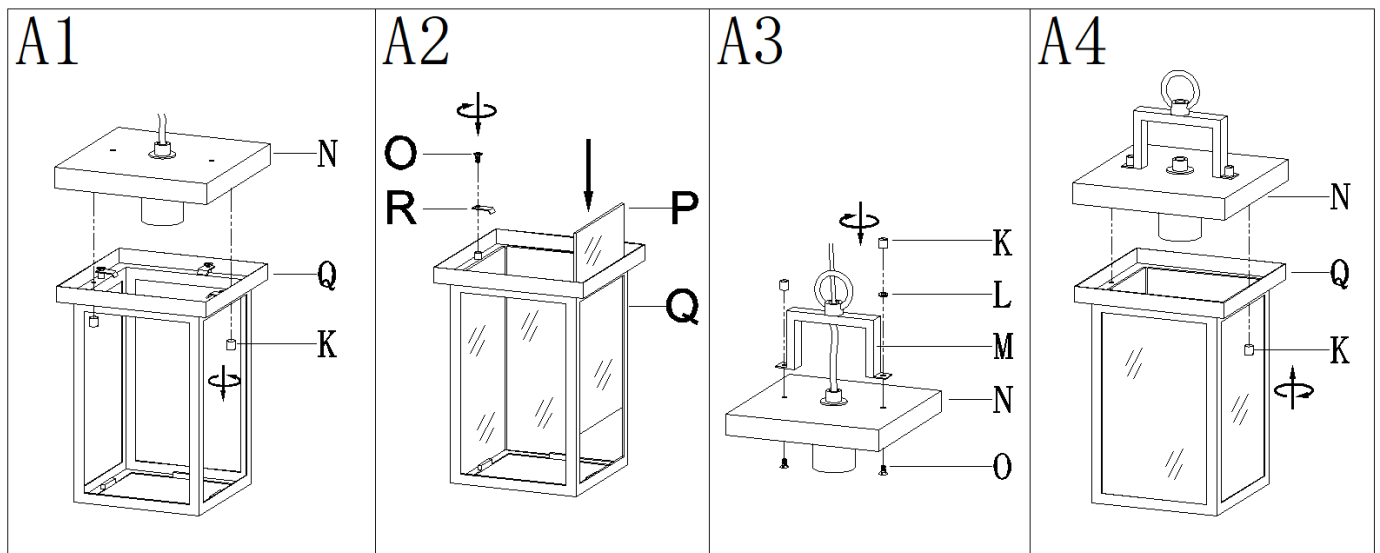

Step A1: Unscrew knob nut (K) and remove iron frame (Q) from cover (N).

Step A2: Carefully insert all glass plates (P) from the top of the iron frame (Q), then put iron pieces (R) against the glass plate (P) and tighten with screws (O).

Step A3: Thread screws (O) through the cover (N) and square tube frame (M), then tighten with plastic washers (L) and knob nuts (K).

Step A4: Align the holes in the iron frame (Q) and the cover (N), then tighten with the previously removed knob nuts (K).

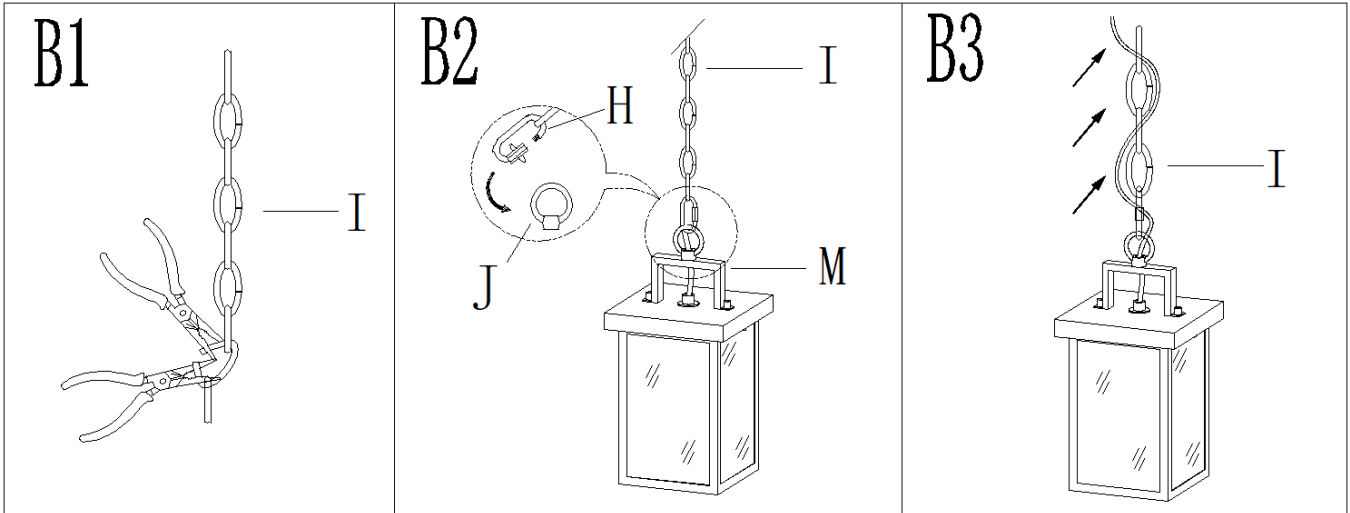

Step B1: By measuring, determine the correct number of links needed for proper hanging height. Using the chain pliers, disconnect and discard the unwanted part.

Step B2: Attach the quick link (H) to connect the chain (I) and the loop (J) on the top of square tube frame (M).

Step B3: Carefully weave the wires through the chain (I) in and out of every other link and stop just when you reach the top of chain (I). Gently pull the wires to ensure the wires are not stressed.

3. Turn off power

Before you start the installation, **NEVER** attempt any work without shutting off the electricity until the work is done.

A) Go to the main fuse, or circuit breaker, box in your home. Place the main power switch in the "OFF" position.

B) Place the wall switch in the "OFF" position.

4. Make installation

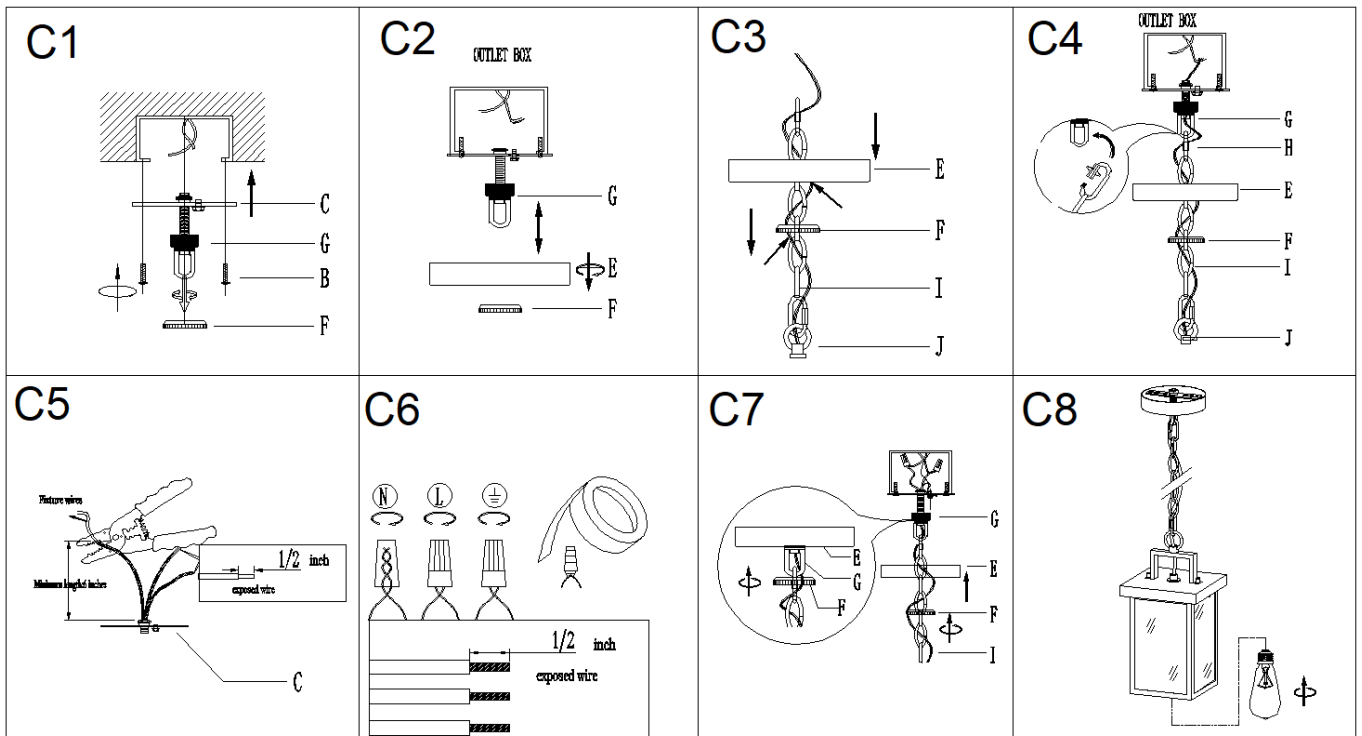

Step C1: Remove the collar ring (F) from collar loop (G). Attach the single bar (C) to outlet box with mounting screws (B). **Note: be sure that the side of single bar marked "GND" must face out.**

Step C2: Raise the canopy (E) over the collar loop (G) and screw the collar ring (F) to measure a proper position. Unscrew collar ring (F) from the collar loop (G) and remove the canopy (E). Refer to the following note, you would know the proper position where the collar loop (G) should be located.

Note: The canopy (E) should be snug against the ceiling and the collar loop (G) should be screwed enough threads (no less than 6 threads) onto the pre-assembled threaded nipple for more secure hanging. If not, adjust the collar loop (G) on the single bar assembly by screwing the collar loop (G) in or out of the single bar (C) until the secure length is achieved.

Step C3: Slip the collar ring (F) over the chain (I), then do the same with the canopy (E).

Step C4: Open the quick link (H), attach the quick link (H) to connect the collar loop (G). Close the quick link (H). Pass the fixture wires through the collar loop (G) to the top of the pre-assembled threaded nipple and gently pull to ensure the wires are not stressed.

Step C5: If needed, shorten the length of fixture wires. At this point, the remaining wire length measured above the single bar (C) is at least 6".

Step C6: Make wire connections

Connect wires as below wires connection shown. **PLEASE NOTE THAT GROUND WIRE IS BARE COPPER WIRE, NEVER CONNECT OTHER WIRES TO GROUND WIRES.**

Connect ground wires according to the below chart

Connect wires according to the below chart

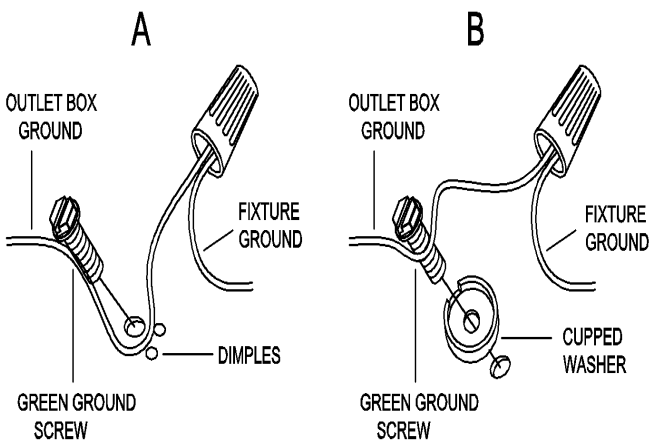

Connect Black or Red Supply Wire to:	Connect White Supply Wire to:
Black	White
*Parallel cord (round & smooth)	*Parallel cord (square & ridged)
Clear, Brown, Gold or Black without tracer	Clear, Brown, Gold or Black with tracer
Insulated wire (other than green) with copper conductor	Insulated wire (other than green) with silver conductor

*Note: When parallel wires (SPT I & SPT II) are used. The neutral wire is square shaped or ridged and the other wire will be round in shape or smooth (see illus.)

Neutral Wire

Twist wires together with plastic wire connector until tightly joined, and wrap each connector with approved electrical tape. Be sure that no wire strands are exposed and then carefully tuck all wires into the outlet box.

Step C7: Raise canopy (E) to ceiling and secure canopy (E) in place by tightening collar ring (F) onto collar loop (G).

Step C8: Install bulbs (not included) (Please do not exceed the maximum wattage recommended on the socket.)

5. Check everything is already installed properly, then you could turn on the light. Enjoy!

CLEANING.

To clean, wipe the fixture with a soft cloth. Do not use abrasive materials such as scouring pads or powders, steel wool or abrasive paper.

ORDERING PARTS.

Keep this sheet for future reference in case you need to order replacement parts. All parts for this fixture can be ordered from the place of purchase. Be sure to use exact wording from illustration when ordering parts.