

ZUNI-26' COUNTER STOOL 203-581

ASSEMBLY INSTRUCTIONS INSTRUCTION D'ASSEMBLAGE



A

Bx2

C

D

E





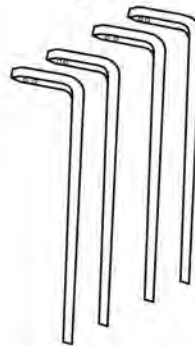
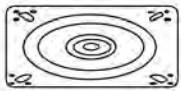



Fx4

G



TURN TOP UPSIDE DOWN ON A SOFT WORKING SURFACE.

RETOURNEZ LE MEUBLE DANS L' AUTRE SENS SUR UNE SURFACE DE TRAVAIL NON RIGIDE.

<p>a M6*35MM</p>  <p>4+1pcs/unites</p>	<p>b M6*30MM+M6*14*1</p>  <p>4+1pcs/unites</p>	<p>c M6*20MM</p>  <p>10+1pcs/unites</p>	<p>d M6*20MM+M6*14*1</p>  <p>4+1pcs/unites</p>	<p>e M6*16MM</p>  <p>2+1pcs/unites</p>
<p>f</p>  <p>2 pcs/unites</p>	<p>g</p>  <p>4 pcs/unites</p>	<p>h M6</p>  <p>1 pcs/unites</p>		

STEP 1 / ÉTAPE 1

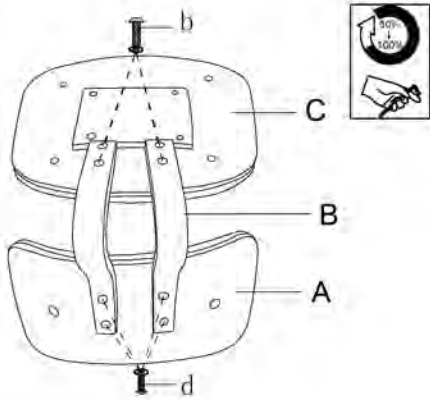

STEP 2 / ÉTAPE 2

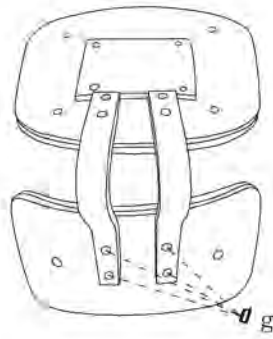

STEP 3 / ÉTAPE 3

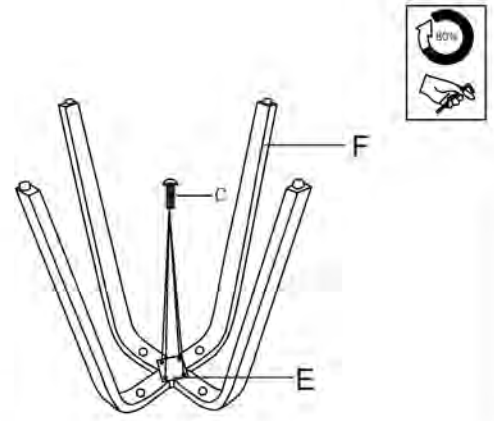

STEP 4 / ÉTAPE 4

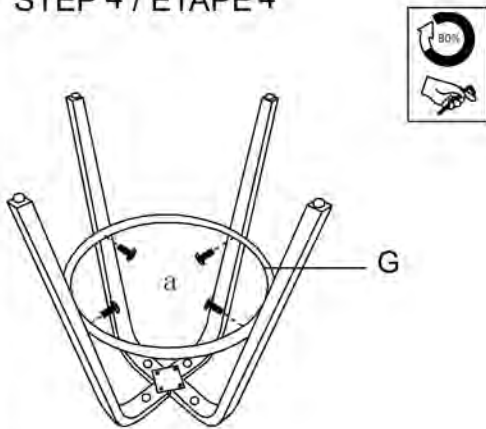

STEP 5 / ÉTAPE 5



Fasten All screws indicate on Step 3 & Step 4.

STEP 6 / ÉTAPE 6

