



Apron Front Stainless Steel Sinks

Installation Instructions

Apron Front Sinks

- LXAFS881R
- LXAFD881R
- CXZAD881
- CXZAF881

Tools You Will Need

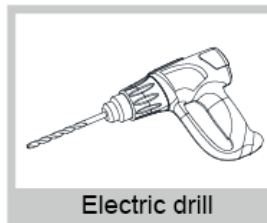
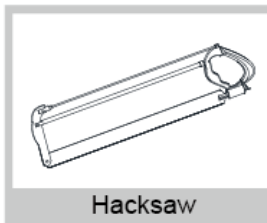
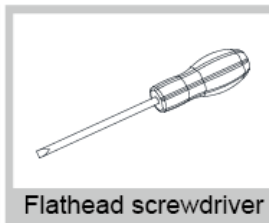
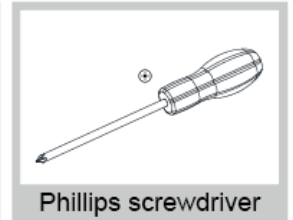
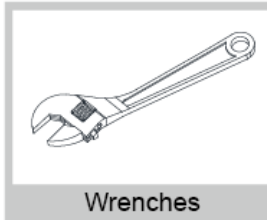
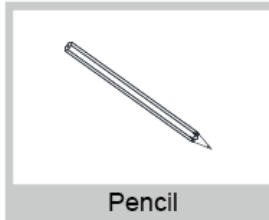
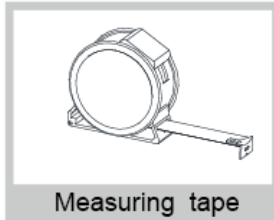

INSTALLATION TIPS

- For optimum installation results homeowner, cabinet maker, countertop and sink installers should all be involved in the planning and installation process.
- The manufacturer suggests this sink be installed by a locally licensed professional and recommends using the actual sink to determine the final cabinet and countertop dimensions.
- Prior to installation be sure to inspect sink for damage. The manufacturer is not responsible for damage caused during installation or by improper installation.
- Be sure to use proper tools and always wear personal protective equipment for your safety.
- Caution: Metal edges may be sharp – handle with care.





Apron Front Stainless Steel Sinks

Installation / Installation / Instalación

Step 1 – Preparing the base cabinet

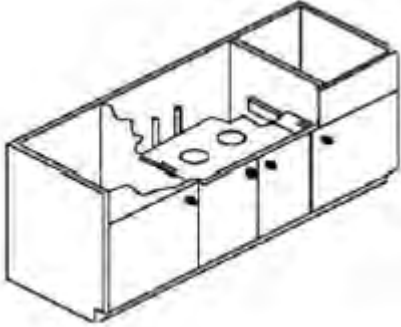

Apron sinks require a base cabinet with an opening in the front of the cabinet. In addition, unlike a standard undermount or top mount sink which may be supported by a countertop, this sink should be supported independently by the cabinet. The support should be sufficient for the weight of a completely filled sink plus any attachments such as garbage disposals and an additional safety factor. A licensed contractor should be able to design adequate support.

Depending on the width and structural integrity of your cabinet, this can generally be accomplished by mounting 2" x 4" wood supports on both inner cabinet side walls, or by building a platform (out of plywood and 2" x 4" vertical braces). We recommend gluing and screwing the bracing to the sink base cabinet, but take care that screws do not penetrate through to any finished, visible surfaces. The finished height of the support structure should be spaced to allow the sink (when placed on the support) to reach just touching the countertop material. Allow space in the platform for water line supplies and the sink drain hole or garbage disposal adapter.

Step 2 – Fitting the base cabinet

Test fit the sink to the cabinet opening. Make any necessary adjustments to the width of the opening by either adding filler strips to the cabinet on the sides of the apron, or by cutting or sanding the cabinet opening to fit. These sinks are designed so that the apron sits forward approximately 1" outward from the face of the cabinet. Also, confirm the top of the sink is flush with the top of the cabinet so the countertop will make a tight seal.



Step 3 – Preparing the countertop

We recommend that apron sinks be installed either flush, where the countertop is cut to the exact size of the sink width, or with a "positive reveal", with the countertop edge sitting back from the bowl of the sink, exposing 1/16" to 1/4" of the sink rim, as seen in the cross section view here.



****Templates are supplied as a guide. We recommend using the actual sink for the most accurate cut.****



Step 4 – Installing the countertop

If using a solid surface counter such as quartz or granite, install the fabricated countertop by cleaning the bottom of the countertop and the top flange (or lip) of the sink with denatured alcohol. Then apply a narrow bead of silicone or adhesive sealant to the top edge of the bowl flange. Place the countertop on the sink. Remove excess sealant from the inside lip of the bowl using a cleaner recommended by the sealant supplier. For installation with other countertop materials and types, please consult your installer for professional installation advice.





Apron Front Stainless Steel Sinks

Installation / Installation / Instalación

Care & Cleaning Guidelines

Cleaning

- Daily, regular cleaning to remove dirt and prevent staining is recommended. Use liquid dish detergent, water and a soft household sponge.
- Mild, non-abrasive cleaners can be used with a nylon scrub pad. To ensure a uniform appearance in a stainless steel sink surface, rinse with water and wipe down the sink with a soft, dry cloth. Drying the sink will prevent water spots caused by time in the water.
- Remove stubborn stains from lime or calcium deposits by pouring a little warm vinegar or vinegar-based cleaner into the sink and allow it to sit for a few minutes. Rinse with clean water and dry.

Please note chlorides are found in most all soap, detergents, bleaches and cleansers. Chlorides can be harsh on stainless steel. Rinse your sink thoroughly after each use to remove any chloride residue.

Scratches

Scratches are inevitable during your usage over time. To treat, use a nylon pad with an iron free abrasive polishing compound. Follow the original polish lines to blend out the scratch in a small area. Be cautious not to overdo the process, as cleaning too aggressively could result in a bright spot.

Rust Spots

Stainless steel does not rust. Rust stains are the result of iron particles introduced by water, cookware, and steel wool pads that react with water to create rust. Metal cleaners will remove rust spots.

Food Stains

Depending on the severity of the stain, use a bleach and water solution or pour the bleach onto a cloth and cover the stain. Allow the bleach to sit for at least 1/2 hour and then clean with dish detergent and water.

Some Don'ts

- DO NOT use strong abrasive cleaners, metal scrub pads, or steel wool. These will scratch the surface.
- DO NOT leave rubber mats or sponges inside the sink. Water trapped below could lead to stains.
- DO NOT let food with a high salt content sit inside the sink for prolonged periods of time.
- DO NOT allow chlorine bleach to sit inside a stainless steel sink for more than 1 hour.
- DO NOT allow drain cleaners to come into contact with the sink surface.
- DO NOT pour paint in your sink. The chemicals in acrylic paint will react with sinks if allowed to sit over 24 hours and will produce permanent marks. For latex based paints, remove any residue immediately using a paint remover manufactured by the same brand. Consult the paint remover recommendations before using on the sink. For all sinks, we also recommend nail polish remover, rubbing alcohol or an acetone based paint remover to eliminate paint residue.





LIMITED LIFETIME SINK WARRANTY

MLUX warrants to the original purchaser of MLUX Stainless Steel sinks installed in the United States or Canada for as long as the original purchaser owns his or her home that MLUX will provide an equivalent sink to replace any MLUX Stainless Steel sink that fails due to a manufacturing defect provided that the sink has been solely for residential use and has not been damaged due to abuse, misuse, or negligence. This limited warranty does not cover and MLUX is not liable for transportation costs, labor charges incurred and/or damages sustained during the course of installation, repair, or replacement of any product(s) provided under this limited warranty. This limited warranty is nontransferable.

To execute a warranty claim, the original purchaser must return to the place of purchase and validate that they are the original buyer of the sink by supplying the original sales receipt.

MLUX has the right to inspect any sink reported to be defective prior to replacement of the sink. All decisions are final. Replacement of the sink does not include removal of the defective sink, installation of the replacement sink, replacement of faucet, replacement of any parts, or any other related expense.

This warranty shall not apply in the event of:

- Improper installation or modification of a MLUX sink
- Damages resulting from abuse including dents resulting from impact of dropped objects
- Damages resulting from improper care or maintenance
- Normal use including scuffs or scratches
- Improper use (such as exposure to corrosive chemicals or cleaning compounds)
- Commercial use

Disclaimers. EXCEPT AS SET FORTH ABOVE, MLUX MAKES NO WARRANTIES, WHETHER EXPRESS, IMPLIED, OR STATUTORY REGARDING OR RELATING TO THE PRODUCT OR SERVICE SUPPLIED HEREUNDER. THE PRODUCT MANUAL, OR ANY MATERIALS OR SPECIFICATION PROVIDED BY MLUX, DOES NOT PROVIDE ANY WARRANTY WHATSOEVER. TO THE GREATEST EXTENT ALLOWED BY LAW, MLUX SPECIFICALLY DISCLAIMS ALL IMPLIED WARRANTIES OF MERCHANTABILITY AND FITNESS FOR A PARTICULAR PURPOSE (EVEN IF MLUX HAD BEEN INFORMED OF SUCH PURPOSE) WITH RESPECT TO THE PRODUCT.

Limitation on Damages. In no event shall the liability of MLUX exceed the purchase price of the sink. MLUX disclaims liability for any special, incidental, consequential, punitive or exemplary damages arising out of or in connection with the product, any other materials or services furnished hereunder, even if MLUX has been advised, knows, or should know of the possibility of such damages. The preceding constitutes Mainline's entire liability and your sole and exclusive remedy for breach of warranties herein set forth. (Some states do not allow the exclusion or limitation of implied limited warranties, so the above exclusion may not apply to you.) This warranty supersedes all other warranties, expressed or implied. The foregoing warranties are exclusive and made only to the original buyer.

Contact us: Have Questions or in need of support?
Visit our website. See Product Label for more information.

Garantie Limitée à vie de L'évier

MLUX garantit à l'acheteur d'origine que les éviers en acier inoxydable de MLUX installés aux États-Unis ou au Canada tant que l'acheteur d'origine est propriétaire de son domicile seront remplacés par un évier en acier inoxydable MLUX en cas de défaut de fabrication, à condition que l'évier ne soit utilisé qu'à des fins résidentielles et n'ait pas été endommagé suite à un abus, une mauvaise utilisation ou une négligence. La garantie limitée ne couvre pas, et MLUX n'est pas responsable, des frais de transport, de main d'œuvre ou de tout autre dommage ayant lieu durant l'installation, la réparation ou le remplacement de tout produit fourni dans le cadre de cette garantie limitée. Cette garantie limitée n'est pas transférable.

Pour effectuer une réclamation dans le cadre de la garantie, l'acheteur d'origine doit revenir sur le lieu de l'achat et fournir la preuve d'achat d'origine en présentant la facture. MLUX se réserve le droit d'inspecter tout évier déclaré défectueux avant de le remplacer. Toutes les décisions sont finales. Le remplacement de l'évier n'inclut pas le retrait de l'évier défectueux, ni l'installation de l'évier de rechange, le remplacement du robinet ou de toute autre pièce, ni aucun frais associé.

Cette garantie ne s'applique pas dans les cas suivants :

- Installation incorrecte ou modification de l'évier MLUX
- Dommages résultant d'un abus, y compris traces de chocs dues à des impacts ou des chutes d'objets
- Dommages résultant d'un soin ou d'un entretien inadéquats
- Usure normale incluant abrasions ou rayures
- Utilisation incorrecte (telle qu'exposition à des produits chimiques ou des agents de nettoyage corrosifs)
- Utilisation commerciale

Avis de non-responsabilité. EXCEPTÉ TEL QU'INDIQUÉ CI-DESSUS, MLUX N'OFFRE AUCUNE GARANTIE, EXPRESSE, IMPLICITE OU LÉGALE, RELATIVE AU PRODUIT OU AU SERVICE FOURNIS AUX TERMES DES PRÉSENTES. LE MANUEL DU PRODUIT, NI TOUT AUTRE MATÉRIEL OU SPÉCIFICATION FOURNIS PAR MLUX, NE FOURNISSENT DE GARANTIE QUELCONQUE. DANS TOUTE LA MESURE ACCORDÉE PAR LA LOI, MLUX REJETTE SPÉCIFIQUEMENT TOUTE GARANTIE DE QUALITÉ MARCHANDE OU D'ADAPTATION À UN USAGE PARTICULIER (MÊME SI MLUX A ÉTÉ INFORMÉ D'UN TEL OBJET) CONCERNANT LE PRODUIT.

Limitation concernant les dommages. La responsabilité de MLUX ne saurait en aucun cas dépasser le prix d'achat de l'évier. MLUX rejette toute responsabilité relative à des dommages spéciaux, indirects, consécutifs, punitifs ou exemplaires découlant ou relatifs au produit, à tout autre matériel ou service fournis aux termes des présentes, même si MLUX a été averti, connaît, ou devrait connaître la possibilité de tels dommages. Ce qui précède constitue l'intégrale responsabilité de MLUX et le seul et exclusif remède en cas de rupture des garanties présentées ici. (Certains États ne permettant pas l'exclusion ou la limitation de garanties limitées implicites, l'exclusion ci-dessus peut ne pas s'appliquer.) Cette garantie remplace toute autre garantie, expresse ou implicite. Ces présentes garanties sont exclusives et ne sont destinées qu'à l'acheteur d'origine.

