



8x8 Sunshed Garden Shed Assembly Manual Metal Roof - T&G Model

Revision #16.2
October 4, 2022



Reversible
Roof Lines



Thank you for purchasing an 8x8 SunShed Garden Shed from Outdoor Living Today. Please take the time to identify all the parts prior to assembly.

Safety Points and Other Considerations

Our products are built for use based on proper installation and normal residential use, on level ground. Please follow the instruction manual when building your shed and retain the manual for future maintenance purposes.

Some of the safety and usage measures you may wish to consider include:

- snow load ratings vary by geographical location. If heavy or wet snowfall occurs, it is advisable to sweep the snow off the roof(s).
- if the product is elevated, any structural and building code requirements are solely the customer's responsibility, and should be abided by.
- in high or gusty wind conditions it is advisable to keep the structure securely grounded.
- have a regular maintenance plan to ensure screws, doors, windows and parts are tight.

Customer agrees to hold Outdoor Living Today Partnership and any Authorized Dealers free of any liability for improper installation, maintenance and repair.

In the event of a missing or broken piece, simply call the Outdoor Living Today Customer Support Line @ 1-888-658-1658 within 30 days of the delivery of your purchase. It is our commitment to you to courier replacement parts, free of charge, within 10 business days of this notification. Replacement parts will not be provided free of charge after the 30 day grace period.

What to do before my Shed arrives?



- Become familiar with this assembly manual and determine if you can complete the project yourself or will require a professional contractor.



- One helper is recommended to assist in constructing your shed. It generally takes two people over two days to assemble a shed. If you're hiring a contractor, their rate should be in line with that duration of work.



- Clear the construction area and ensure a clear pathway for delivery when the freight company arrives. Remove all debris: roots, grass, rocks, etc.



- Excavate the site. Contact your local utilities company to ensure there are no gas or electric lines buried in the area before digging.

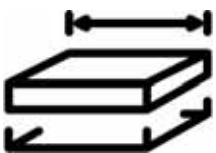

- Decide on the type of foundation you will be using:
 - Concrete slab, or
 - 4-6 inches of crushed gravel with paver stones or 4x4 stringers.

You can find the footprint for your shed on Page 3 of your Assembly Manual.



- If doing the assembly yourself, have all the necessary tools ready to go and in working condition. A list of required tools can be found after the parts list.



Foundation Types for 8x8 Garden Shed

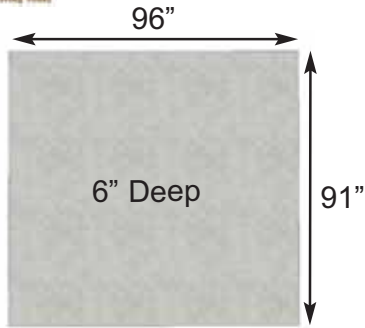

Shed Front

Concrete Foundation

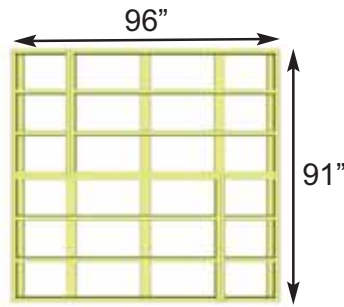

Shed Front

Floor Frame

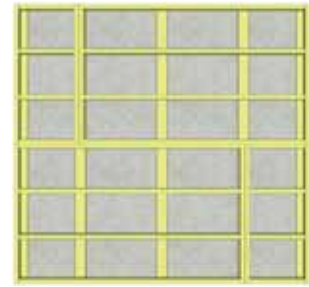

Shed Front

Completed Foundation

Concrete Slab Foundation:

- Slab must be at least the same size as assembled floor frame (91" x 96") or larger.
- 6" Deep foundation.
- 1.2 Cubic Yards of concrete required.
- A concrete slab will have the longest durability out of your foundation options.

Once level, a concrete slab is the easiest surface to build on.

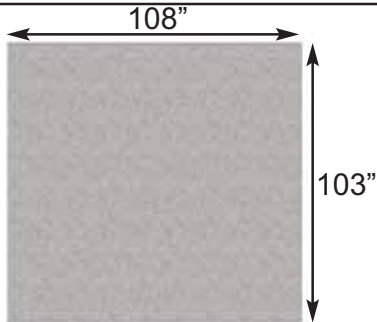

Shed Front

Gravel Foundation

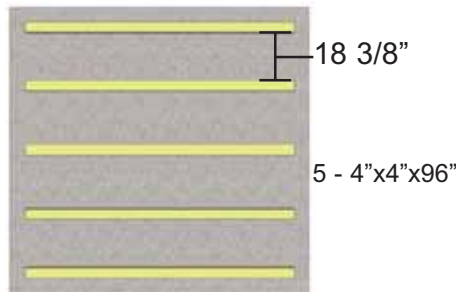

Shed Front

Gravel Foundation with treated stringers

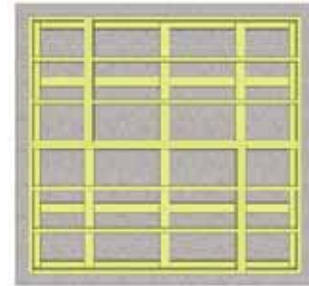

Shed Front

Completed Foundation

Gravel with 4x4 Pressure Treated Stringers:

- Excavate at least 6" deep, and 6" wider than floor frame on each side.
- 1.5 Cubic Yards of gravel required, approximately 14 wheelbarrows.
- 5 - 4x4 Pressure Treated Stringers 8' long required.
- Evenly spaced, with one at each end of floor frame.

Saves money on materials, easy to level and work with.

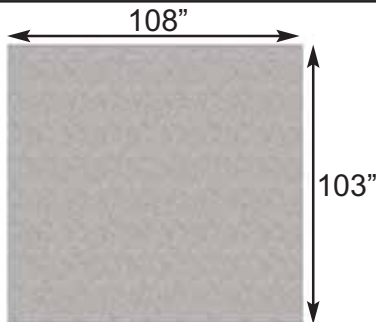

Shed Front

Gravel Foundation

25 Patio Stones

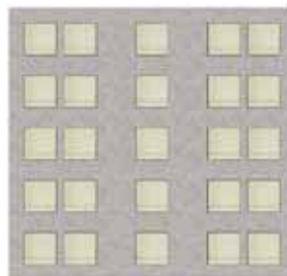

Shed Front

Gravel Foundation with Patio Pavers

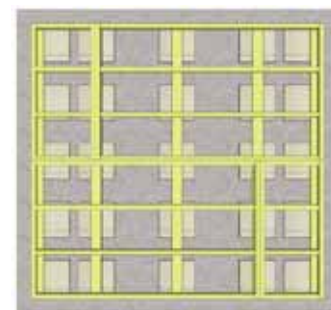

Shed Front

Completed Foundation

Gravel with Patio Paver Stones:

- Excavate at least 6" deep, and 6" wider than floor frame on each side.
- 1.5 Cubic Yards of gravel required, approximately 14 wheelbarrows.
- 25 patio pavers (8" x 8" or larger).
- Center patio paver stones underneath floor runners and underneath seams in floor joists.

Patio paver stones are widely available from most landscape stores.

Thank you for purchasing our 8x8 Sunshed Garden Shed. (Metal Roof)
Please take the time to identify all the parts prior to assembly.

Parts Lists: 8x8 Sunshed

A. Floor Section

- 2 - 45 1/2" x 75" - Floor Joist Frames (Interior Joist Unattached)
- 2 - 45 1/2" x 21" - Floor Joist Frames (Interior Joists Attached)
- 4 - 1 1/2" x 3 1/2" x 71 3/4" - Floor Joists
- 2 - 45 3/8" x 74 7/8" - Floor Plywood
- 2 - 45 3/8" x 20 7/8" - Floor Plywood
- 5 - 1 1/2" x 3 1/2" x 60" - Floor Runners - Long
- 5 - 1 1/2" x 3 1/2" x 31" - Floor Runners - Short

B. Wall Section

Main Wall Panels

- 3 - 45 1/2" x 84" - Solid Wall Panels
- 3 - 1 1/2" x 2 1/2" x 45 1/2" Wall Plates
- 2 - 45 1/2" x 84" - Window Wall Panels
- 2 - 45 1/2" x 75" - Double Window Walls
- 1 - 12" x 73" - Narrow Wall Panel
- 1 - 31 1/2" x 72" Dutch Door - 2pcs (42" and 30" high)
- 1 - 45 1/2" x 9" - Wall Extender
- 2 - 3/4" x 3 1/2" x 60" - Horizontal Wall Extender Brace
- 2 - 3/4" x 3 1/2" x 30" - Horizontal Wall Extender Brace (front/back)
- 2 - 3/4" x 3 1/2" x 20 1/4" - Horizontal Wall Extender Brace (side)
- 2 - 3/4" x 3 1/2" x 65 3/4" - Horizontal Wall Extender Brace (side)

Door Jamb, Header & Door Stops

- 1 - 1 1/2" x 3 1/8" x 73" - Vertical Door Jamb
- 1 - 2" x 3 1/8" x 45 1/2" - Door Header
- 2 - 1/2" x 2 1/2" x 72" - Interior Vertical Door Stops

Gable Walls

- 2 - Front and Rear Gable Walls - Triangular shaped (33 3/4 degrees on 1 side / 22 1/2 degrees on other)
- 2 - Triangular Gable Trims - (L/R) Found stapled to inside of Gable in each corner - see step 63)

Top Wall Plates

- 1 - 3/4" x 2 1/2" x 86" - Double Window Wall Side - 22 deg. cut on edge
- 1 - 1 1/2" x 2 1/2" x 86" - Solid Wall Side - 33.75 deg. cut on edge
- 2 - 3/4" x 2 1/2" x 73 3/4" Front & Rear (33 3/4 degrees on 1 end / 22 1/2 degrees on other)

C. Rafter Section

- 6 - 1 1/2" x 3 1/2" x 77 3/4" - Long Roof Side Rafters (22 1/2 degrees)
- 6 - 1 1/2" x 3 1/2" x 37 3/4" - Short Roof Side Rafters (33 3/4 degrees)
- 1 - 3/4" x 4 5/8" x 33 1/2" - Ridge Boards (long roof side)
- 1 - 3/4" x 4 5/8" x 57 1/2" - Ridge Boards (long roof side)
- 1 - 3/4" x 5 1/8" x 33 1/2" - Ridge Boards (short roof side)
- 1 - 3/4" x 5 1/8" x 57 1/2" - Ridge Boards (short roof side)
- 3 - 3/4" x 3 1/2" x 72 - Gussets (angle cut on both ends)

Soffits

- 2 - 1/2" x 3 1/2" x 45 1/2" Short Roof Side
- 2 - 1/2" x 4 1/2" x 45 1/2" Long Roof Side

D. Roof Section

- 4 - 3/4" x 1 1/2" x 34" - F&R Roof/Facia Nailing Strips
- 8 - 3/4" x 3/4" x 44 1/2" - Polygal Support Cleats
- 2 - 1/2" x 2 1/2" x 41 1/2" - Mid Ridge Caps for Polygal
- 1 - 1/2" x 4 1/2" x 41 1/2" - Center Ridge Cap for Polygal
- 2 - 1/2" x 5 1/2" x 41 1/2" - Outside Caps for Polygal (w nailing strip)
- 4 - 20 1/4" w x 44" - Polygal Panels

- 12 - 3/4" x 3 1/2" x 48 1/4" Roof Batten
- 4 - 3/4" x 1 1/2" x 13 1/4" - Batten Spacers Short
- 4 - 3/4" x 1 1/2" x 13 1/2" - Batten Spacers Long
- 3 - 41" long x 39" wide Metal Roof Panels Short
- 3 - 43" long x 39" wide - Metal Roof Panels Long
- Several Strips of Foam Enclosures for Metal Roof Ends
- 2 - 13" w x 60" Metal Ridge Cap

E. Miscellaneous Section

Bottom Skirting

- 8 - 1/2" x 4 1/2" x 45 1/4" - Bottom Skirting

Corner & Wall Trim

- 2 - 5/8" x 2 1/2" x 75" - Filler Trim Short Wall Side
- 2 - 5/8" x 2 1/2" x 84" - Filler Trim Tall Wall Side
- 2 - 1/2" x 4 1/2" x 82" - Corner Trim Short Wall Side
- 2 - 1/2" x 4 1/2" x 87" - Corner Trim Tall Wall Side
- 3 - 1/2" x 2 1/2" x 87" - Front Door Trim & Rear Wall Seam Trim
- 3 - 1/2" x 2 1/2" x 88" - Tall Wall Vertical Trim
- 3 - 1/2" x 2 1/2" x 79" - Short Wall Vertical Trim
- 1 - 1/2" x 2 1/2" x 32" - Horizontal Door Trim (above Door)
- 1 - 1/2" x 2 1/2" x 8 3/4" - Horizontal Narrow Wall Trim (above Wall)
- 2 - 1/2" x 4 1/2" x 85 1/2" - Hor.Gable Trim (F & R) Angle cut 1 end

Facia Trim

- 2 - 3/4" x 3 1/2" x 79 1/4" - Angle Cut Front/Rear Facia Trim
- 2 - 3/4" x 3 1/2" x 38 3/4" - Angle Cut Front/Rear Facia Trim
- 4 - 3/4" x 3 1/2" x 47 7/8" - Side Facia
- 2 - Facia Detail Plates (sides)
- 2 - Pentagon Detail Plates (front and back)

Flower Boxes

- 4 - Flower Box Kits

Potting Shelves

- 2 - Long Potting Shelves
- 1 - Short Potting Shelf
- 3 - 1 1/2" x 2 1/2" x 38" - Potting Shelf Legs

Window Inserts/Trim

- 2 Reg. Window Inserts
- 4 Small Window Inserts
- 2 Reg. Window Trim Pkg: 1 x 24 1/16" top, 3 x 23" bottom & sides
- 4 Sm. Window Trim Pkg: 1 x 20 1/4" top, 2 x 21 7/16" sides, 1 x 19 1/4" bottom











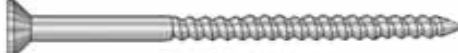



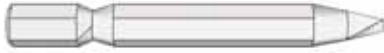

**Miscellaneous Pieces

- 1 pc - Spare Wall Siding
- 2 pcs - Spare Shingles - use to shim door, etc.

Note: All Trim, Facia and Bottom Skirting pieces will be positioned rough face out when installed.

8x8 SUNSHED - METAL HARDWARE SHEET

Hardware Kit (Provided)

- 2 1/2"  x270
- 2"  x78
- 2"  x26
Black Headed
- 1 1/4"  x410
- 1"  x42
Silver
- 1/4"x 2"  x 38
Metal Roof Screw
- 3/4"  x23
Silver
- 3/4"  x16
Black Headed
- 1 1/2"  x428
Finishing
-  x2
Square Drive Bit
-  x 1
1/4" Nut Driver
-  Tee Hinge x4
-  Pull Handle
-  Metal Roof Hanger x 3
-  Ridge Board Connector x 2
- Single Rafter Bracket x 4
(2 @22 deg.)
(2 @33 deg.)
-  Silver Barrel Bolt
-  Silicon Caulking (2)
-  Drop Latch
- Double Rafter Bracket x 2
(1 @22 deg.)
(1 @33 deg.)

Tools Required (Not Provided)

-  Hammer
-  Screw Gun/Drill
-  Tape Measure
-  Wood Clamp
-  Caulking Gun
-  Level
-  Pliers
-  Ladder
-  1/8" Drill Bits

Safety Equipment Required (Not Provided)

-  Safety Glasses
-  Work Gloves

Before/During Assembly:

- 1.) Paint each face and edge of your plywood floor with a latex exterior paint.
- 2.) Caulk wall seams if gaps appear.
- 3.) Caulk around window framing.
- 4.) Caulk perimeter between floor plywood and bottom wall plate.
- 5.) Caulk channels in lap siding at the top of your door above the trim, just a drop in each channel.
- 6.) Caulk edge of door threshold (if applicable).
- 7.) Optional: Install a Sill Gasket between floor runners and foundation.
- 8.) Optional: Install an 8" strip of roofing paper below Cedar Ridge Caps for Cedar Roof Sheds.

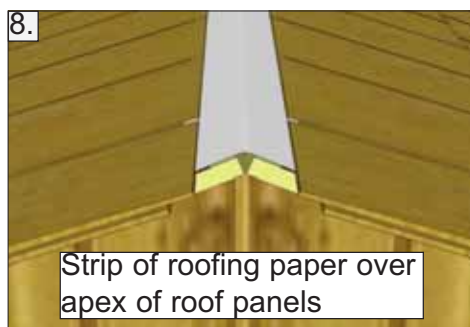
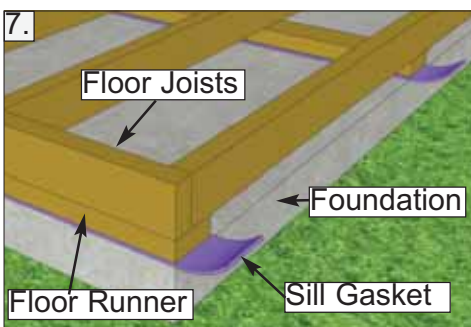
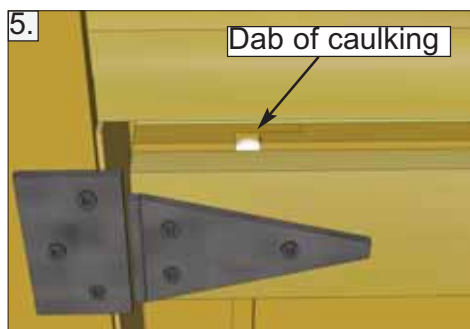
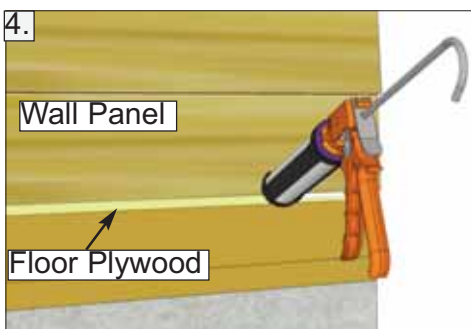
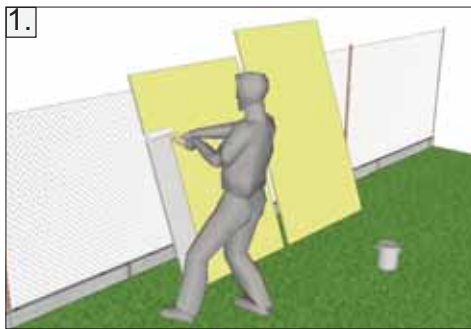

Routine Maintenance:

- Routinely check all fasteners are tight (ex. Door Hinges, Nails)
- Brush off dirt from walls.
- Brush off snow from roof regularly.
- Routinely remove needles and leaves from roof.

Painting/Staining

- Your cedar shed, if left untreated, will weather to a silvery grey colour.
- Painting or staining your structure is highly recommended and will prolong the life of your shed.
- You do not need to wait to paint or stain your shed, the wood in your kit has been dried and can be stained or painted immediately.
- Consult your local paint store for the best paint or stain for cedar.
- Optional: stain the inside of your shed. (Note: this will remove the fresh cedar smell.)

A. Floor Section

Exploded view of all parts necessary to complete Floor Section. Identify all parts prior to starting. Note: Floor Footprint is 96" wide x 91" deep.

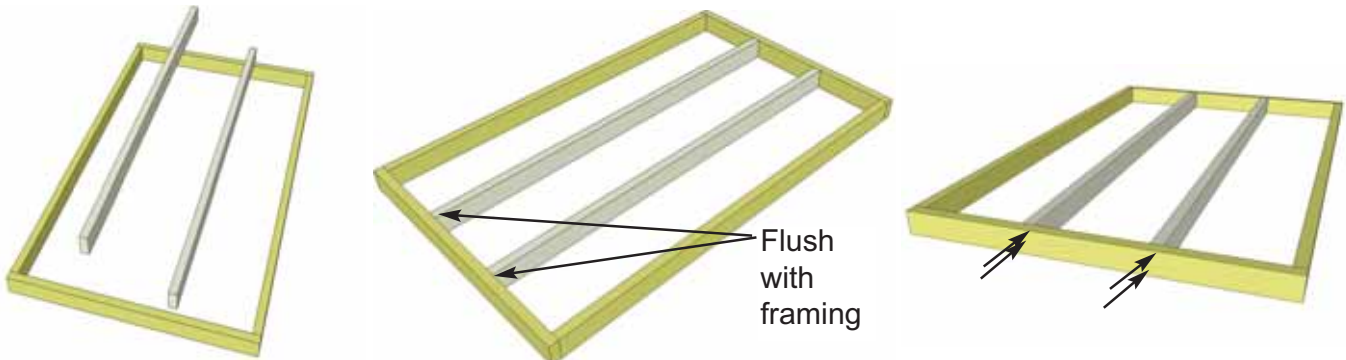
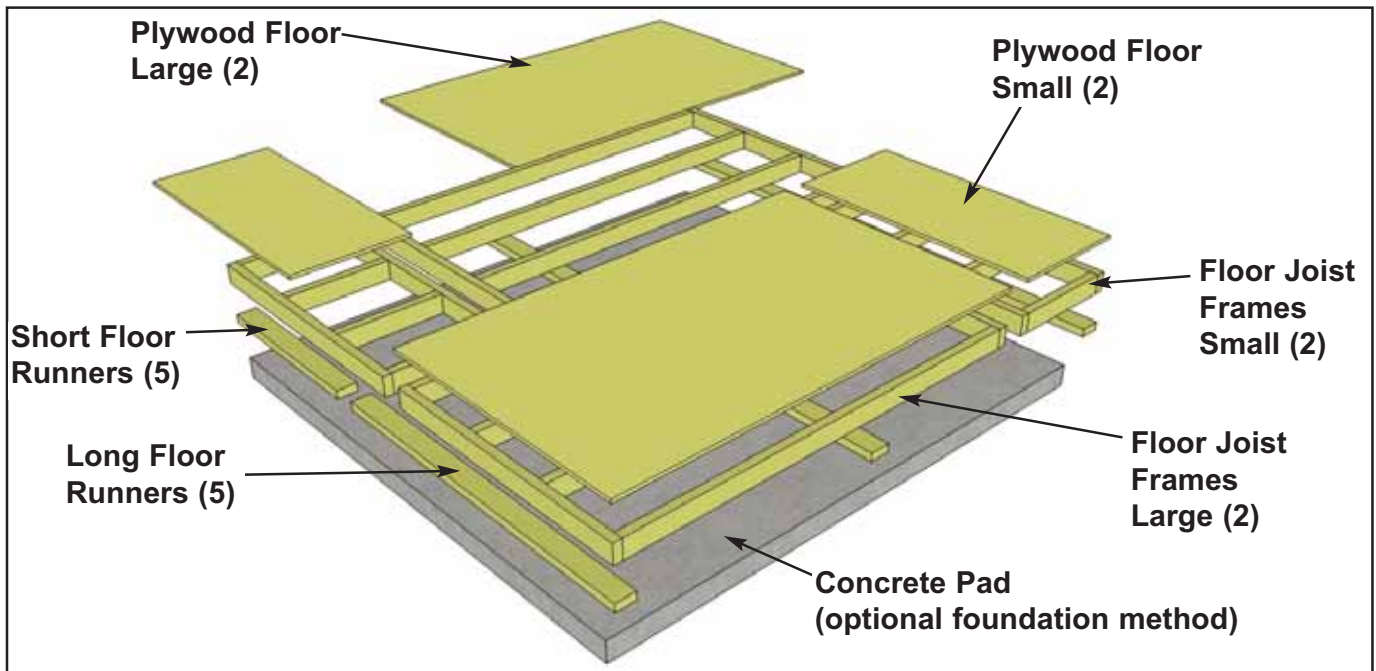

1. Lay out **Large Floor Joist Frame and 2 Floor Joists**. Position Joists equally in Floor Joist Frame. Use **Small Floor Joist Frame** as a template to determine joist position. Position Joist flush with framing. When correctly positioned, attach each Joist with 4 - 2 1/2" screws.

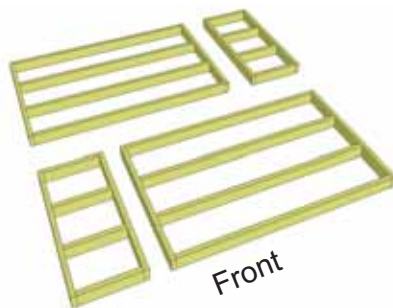

You can find the Square Drive Bit for the screws in with the Hardware Kit Bag.

If reversing roof and walls, also reverse Floor Frames.

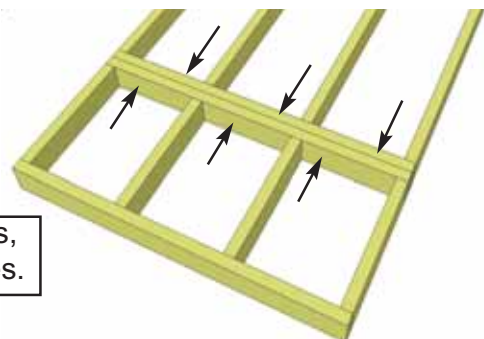

2. Lay out **Floor Joist Frames** as illustrated above. There are 2 larger and 2 smaller Frame Sections. The Footprint for the floor when attached together will be 96" wide x 91" deep.

3. Attach each large and small floor joist frames together with 6 - 2 1/2" screws per section.

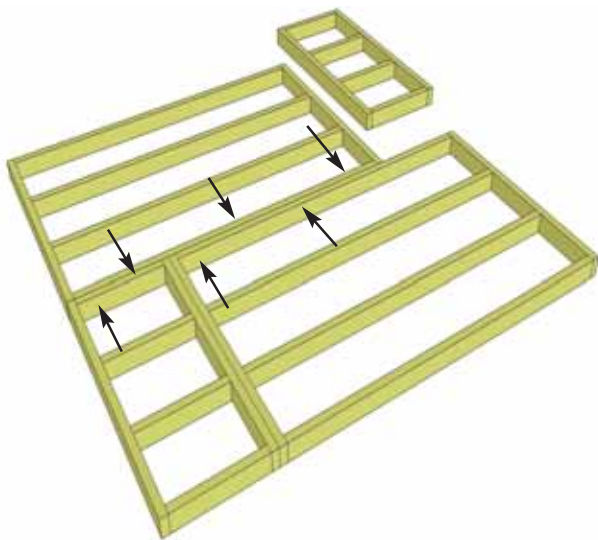

4. Complete all large and small frame attachments. Screw each completed section together with 8 - 2 1/2" screws.

5. When completed, your floor footprint should be 96" wide x 91" deep.

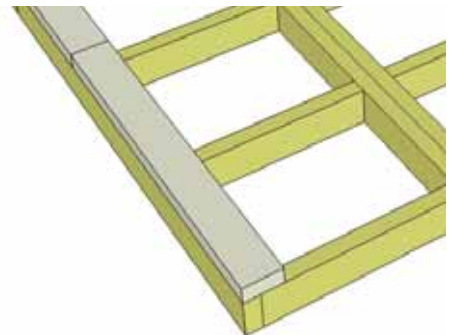
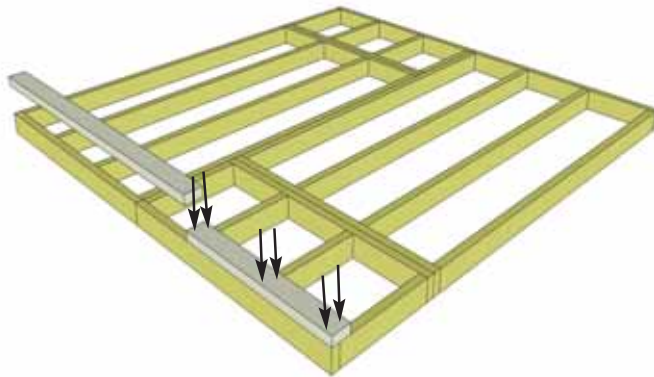
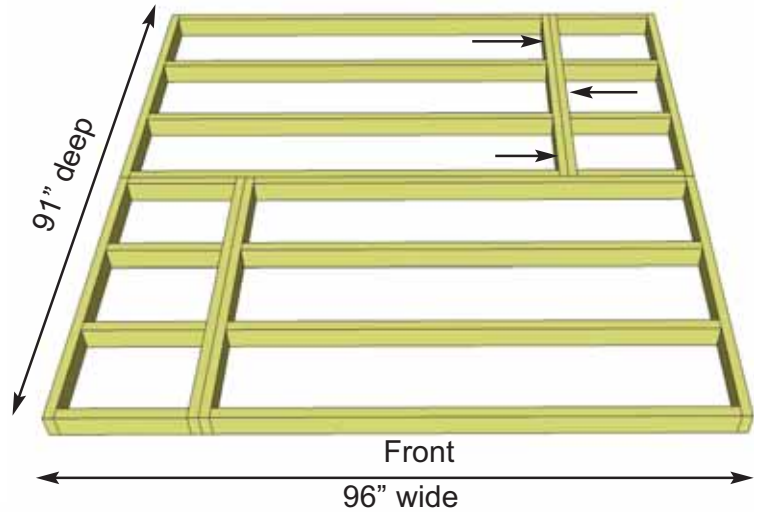

6. Attach **Floor Runners** to completed floor frame. There are 2 floor runners per 91" side and 5 completed runners in total. Use 6 - 2 1/2" screws per Runner.

7. Make sure Runners are flush with floor framing and not overhanging.



8. Complete all Floor Runners, alternating long and short.

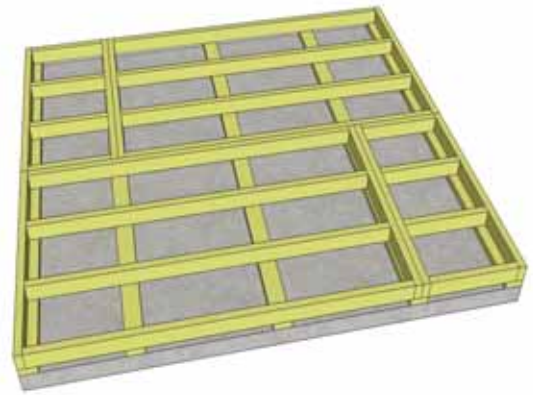
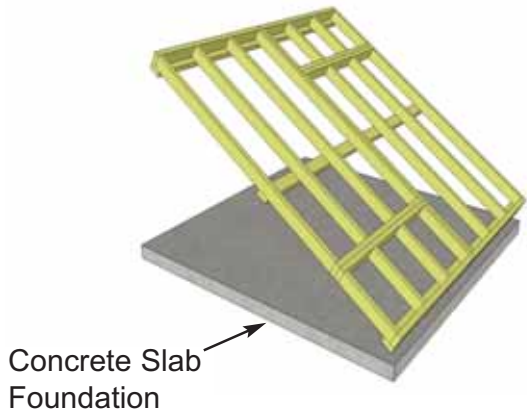

9. With Floor Runners attached, carefully flip the floor over and place on your foundation. **Caution:** you will need 2 people to assist you. Be careful when laying floor down not to bend or twist floor. When in place, level floor completely.

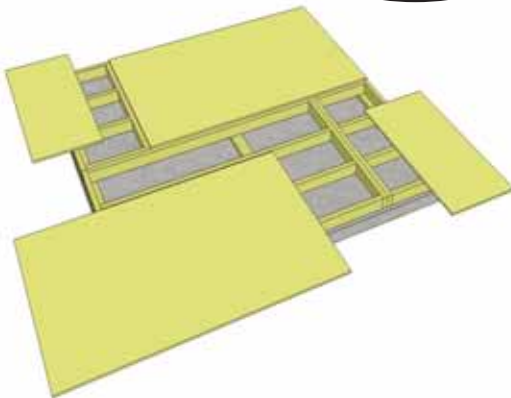
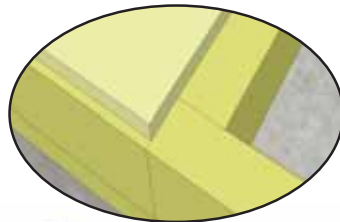

10. Position **Plywood Floor** pieces (4) on top of completed Floor Joists. Plywood will sit slightly back from outside edge of Floor Joist Framing. **The Plywood is cut slightly smaller than floor framing. Keep plywood seams tight.**

Hint: Use a chalk line to mark location of floor joists to determine screw placement.

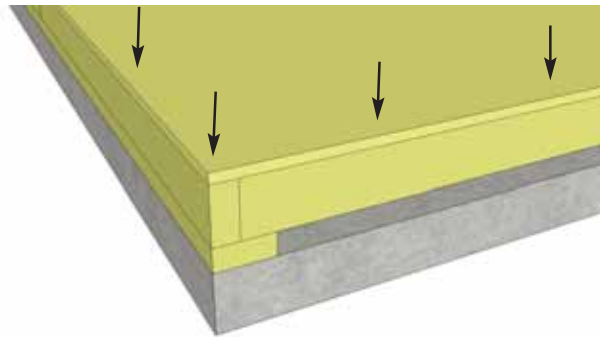
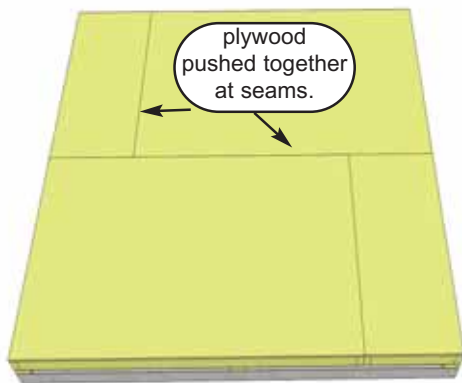
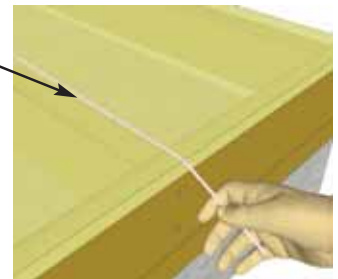

11. With Plywood positioned correctly on floor framing, attach with 1 1/4" screws. Use screws every 16".

B. Wall Section

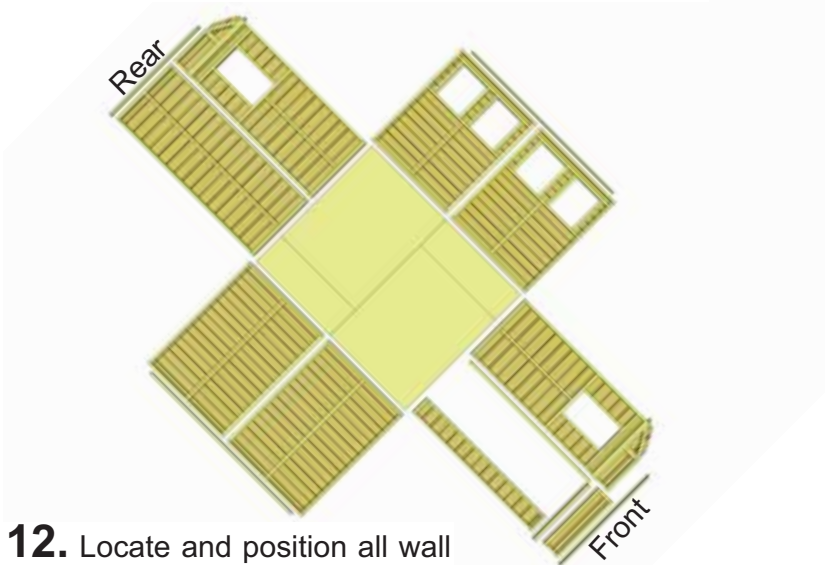

12. Locate and position all wall panels around the perimeter of completed Floor Section.

Left Side Polygal Roof Panel Orientation

Important: If you prefer Polygal Roof Panels on left side when facing front, position wall panels as illustrated above. Follow general assembly directions but note opposite orientations.

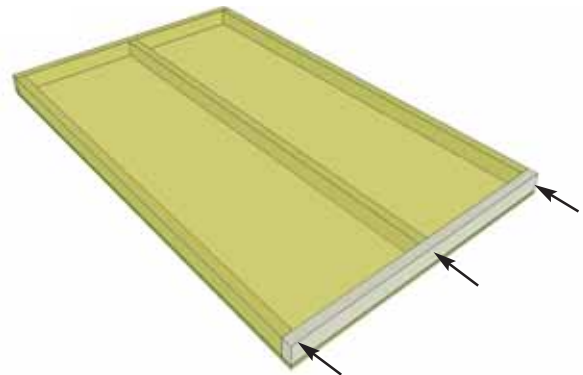
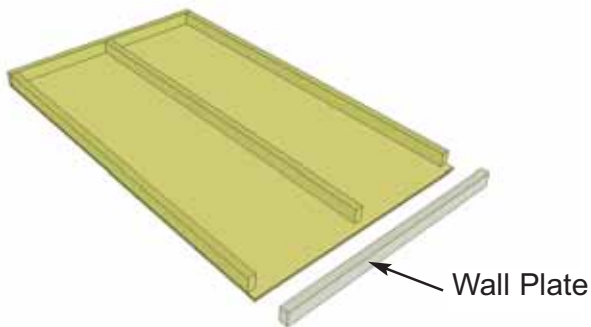

13. Locate 3 **Solid Wall Panels** and 3 **Wall Plates**. Attach Plates to bottom of wall studs of each wall panel with 3 - 2 1/2" screws. Position so plates are flush with framing.

Do Not Attach Walls To Floor until Step 24.

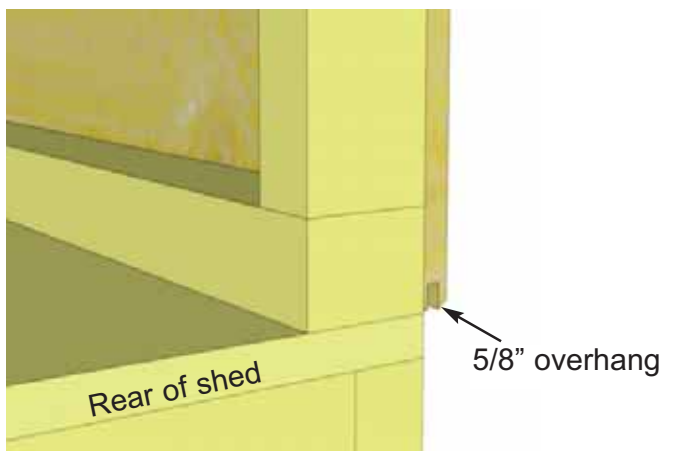

14. Position a **Solid Wall Panel** upright on the floor. Make sure wall siding is facing upright with a groove at the bottom of the wall. See window walls for correct direction of siding. Position panel so wall framing is flush with floor joist framing. Siding of wall will overhang the floor by approximately 5/8".

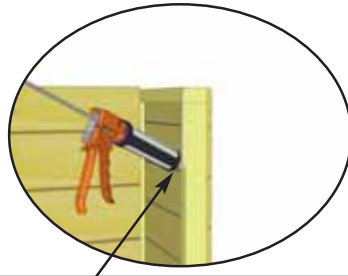
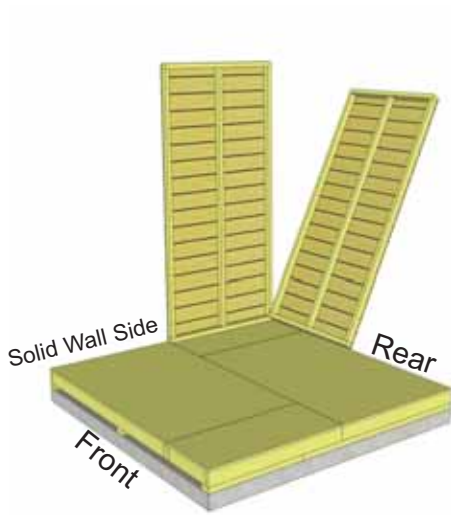

Optional: Caulking seams will help prevent moisture from entering your shed. Caulking is included to complete Polygal Windows only. Additional Caulking may be required for seams.



15. Place a second Solid Wall Panel in the corner, positioning the wall framing flush with floor frame.
Note: Rear walls (and front walls) will be positioned between side walls. Align vertical wall frames and attach with 5 - 2 1/2" screws at bottom, middle and top. Have helper hold wall panels while securing.

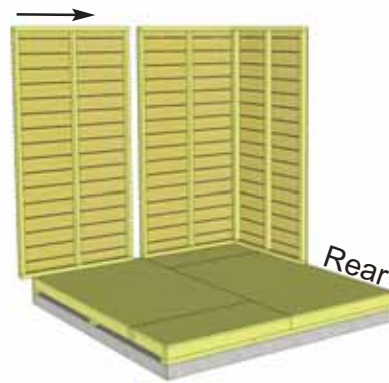

View of Rear Corner showing Solid Wall Side and Rear Wall orientation. Note how the Wall 2x3 bottom framing is flush to floor while siding overhangs floor.

16. Lift and place a third Solid Wall Panel on floor.

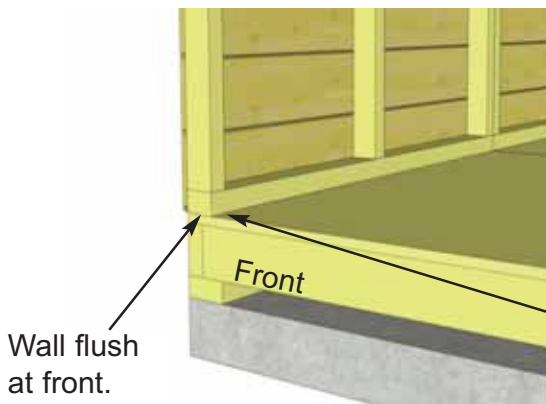

Wall flush at front.



17. Position and attach third wall panel. Secure vertical wall frames together with 5 - 2 1/2" screws. 2x3 wall framing of panel will sit flush with floor framing.



18. Continue adding wall panels around the Sunshed. Align panels on floor as per **Step 14 - 17**. Use 5 - 2 1/2" screws to secure window wall panel together and 3 - 2 1/2" screws to secure double window wall panel.

19. Position and attach **Narrow Wall Panel** to left side wall framing with 3 - 2 1/2" screws as per **Step 15**. **Note:** Narrow Wall is 73" high (2" shorter than double window walls).

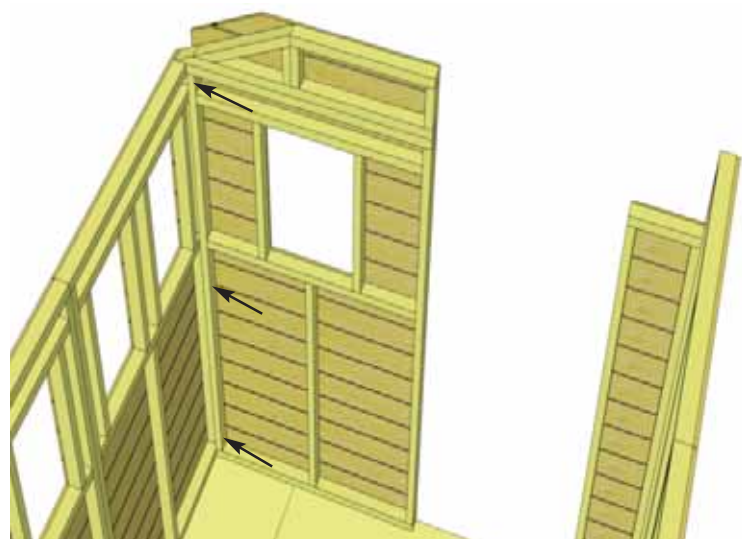
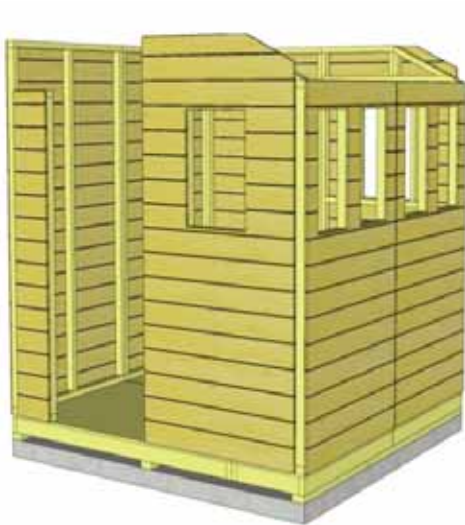
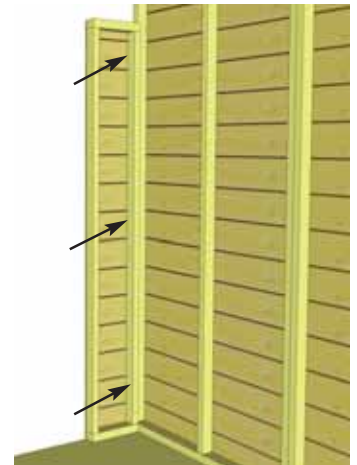

20. Position front Window Wall Panel and attach as per **Step 15**.



Flush with inside of wall stud and outside siding.

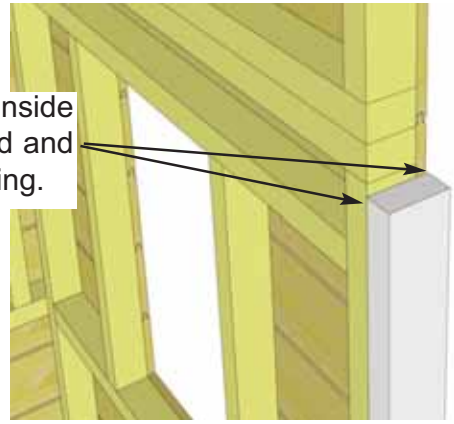

21. Locate **Vertical Door Jamb** (1 1/2" x 3 1/8" x 73") and position flush against right wall panel stud. The Jamb is 3 1/8" wide and will sit flush to outside of wall siding. When positioned correctly, secure Jamb using 4 - 2 1/2" screws.

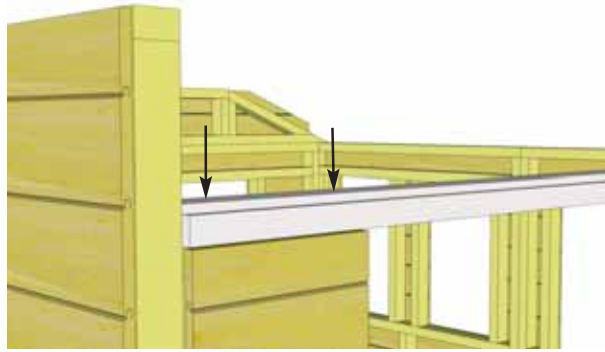
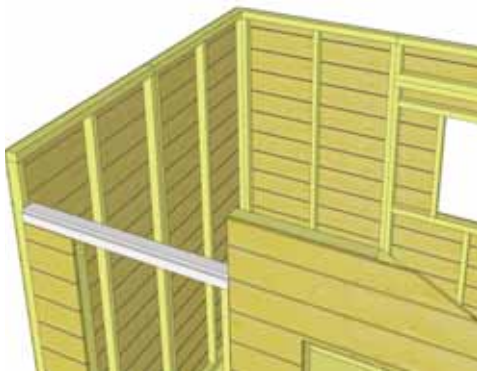

Note: Door Header has cleat attached, place with cleat on top and "notch" facing outward.

22. Position and attach the **Door Header** (2" x 3 1/8" x 45 1/2") to Door Jamb and Narrow Wall Panel top framing. Header should sit flush with Door Jamb and Outside of Narrow Wall Panel Siding. Attach with 4 - 2 1/2" screws.

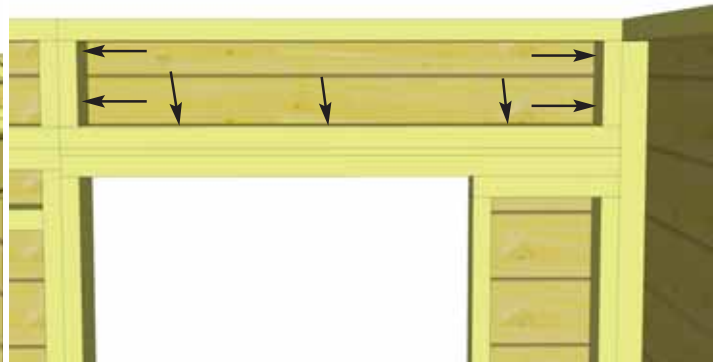
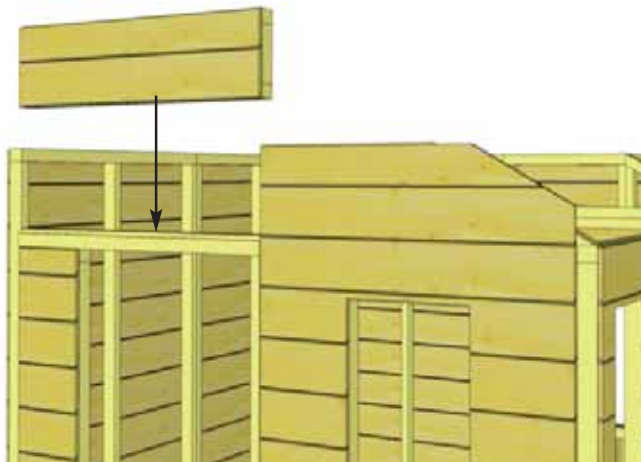

23. Locate and place **Wall Extender** on top of Door Header. Align so 2x3 framing lines up with framing of walls. When correctly in place, secure with 3 - 2 1/2" screws in bottom framing. Secure vertical wall framing of extender with 2 - 2 1/2" screws.

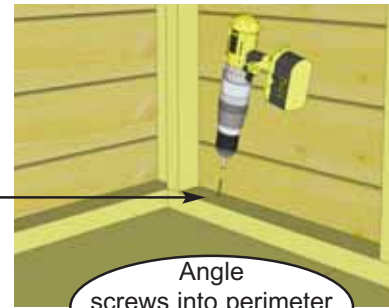
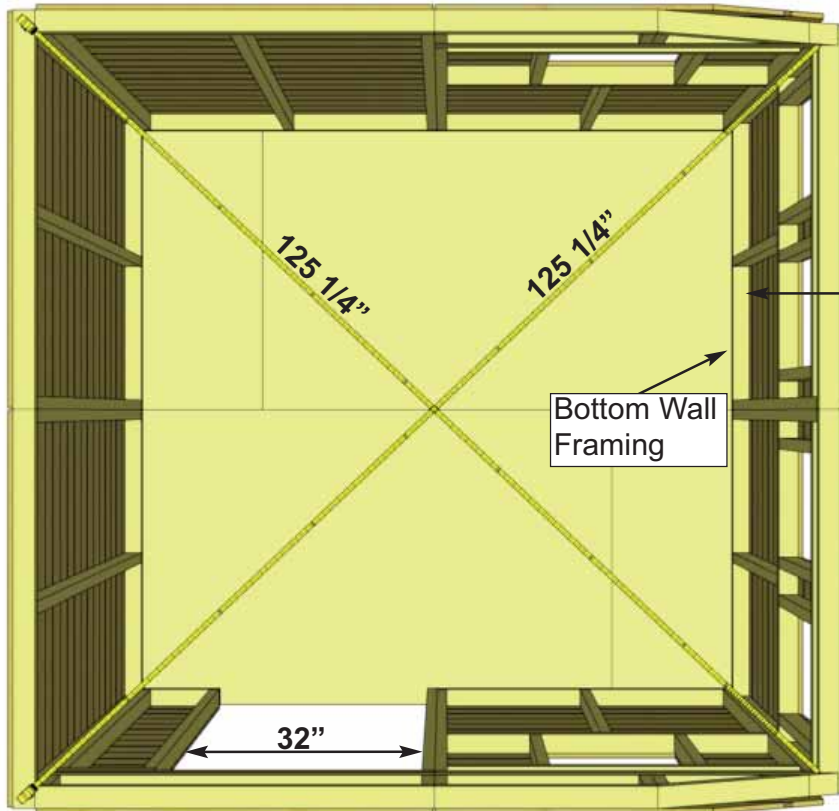

Angle screws into perimeter Floor Joists.

Advice: Prior to fastening walls and installing rafters, take time to confirm your walls are level, square and plumb.

Measure diagonal at top and bottom of walls corner-to-corner. This should be approximately 125 1/4". More importantly, if measurements are not within 1/4", your walls are not square. Adjusting now will make it easier to do the roof section later.

Confirm 32" wide Door Opening prior to attaching walls to floor.

24. When all walls are attached together, check alignment with the floor. Bottom wall framing should sit flush with outside floor framing. When positioned correctly, fasten bottom wall plates to floor using 4 - 2 1/2" screws per wall panel. **Important:** If walls are not lining up and appear higher or lower than each other, your floor may not be LEVEL. Please check the level of your floor. You may need to make slight adjustments to level your floor before proceeding.

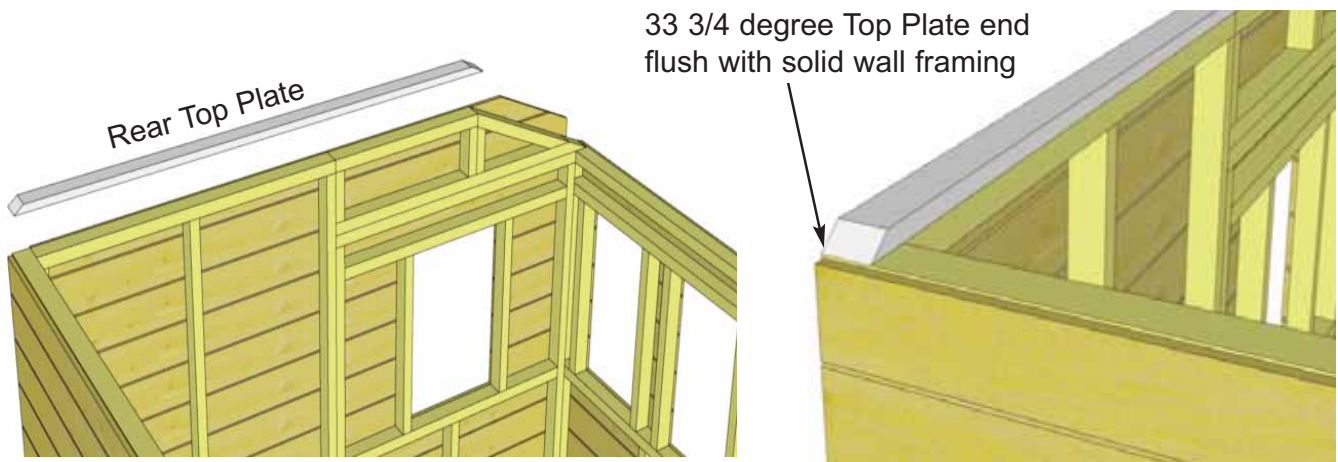

25. Locate **Rear Top Plate** (3/4" x 2 1/2" x 73 3/4") and position on wall flush to inside wall framing. Align so angle cut on 33 3/4 degree end is facing the solid wall side and 22 1/2 degree end is facing double window wall side. **Important:** See Step 26 for Top Plate Angle alignment.

Top Plates should be flush with inside of wall framing.

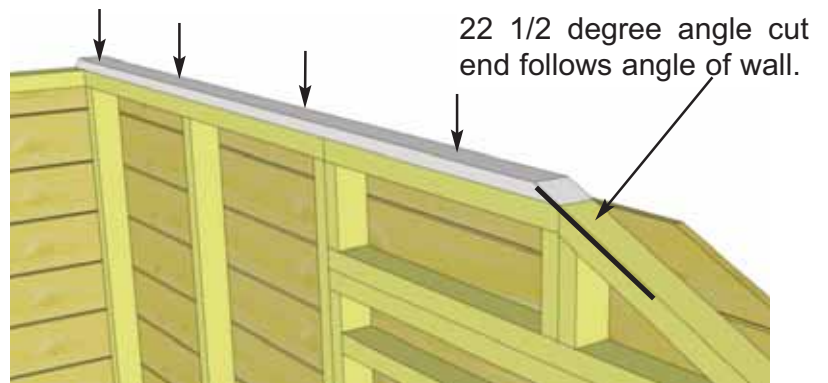
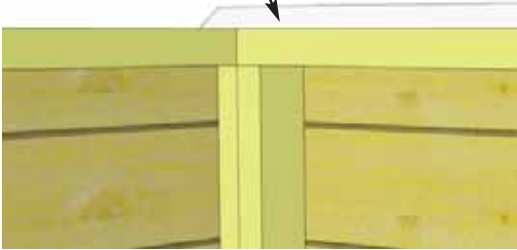

26. When properly positioned, attach by screwing down into wall framing with 4 - 2" screws.

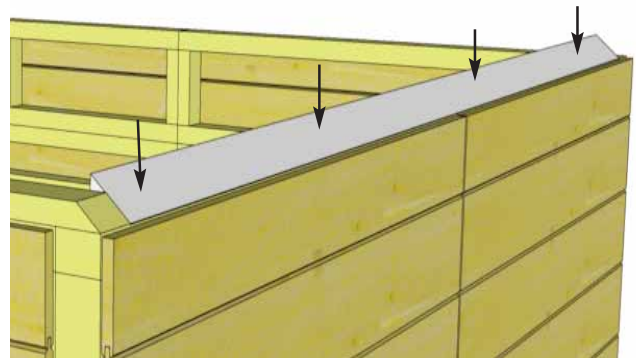
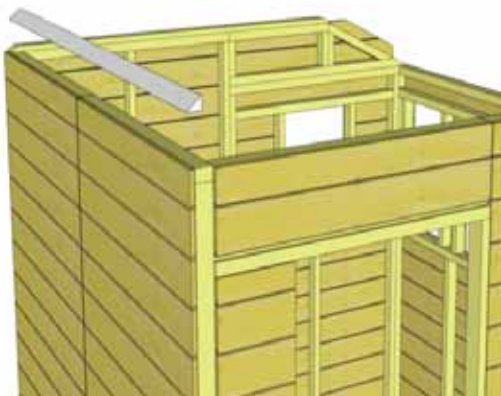

27. Next, attach the **Side Top Plate** (1 1/2" x 2 1/2" x 86" 33 3/4 degree cut down outside edge) to high wall side. Position so that angled edge lines up with angle of rear top plate. Secure with 4 - 2 1/2" screws.

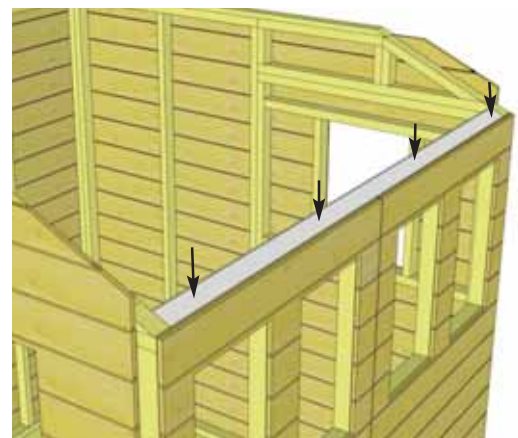
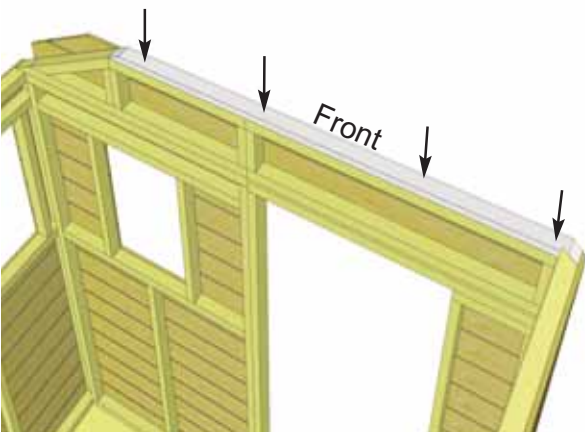

28. Position remaining **Front Top Plate** (3/4" x 2 1/2" x 73 3/4") and Window Wall **Side Top Plate** (3/4" x 2 1/2" x 86") into position on wall framing and secure with 4 - 2" screws per piece. Side Top Plate has a 22 1/2 degree cut down 1 edge.

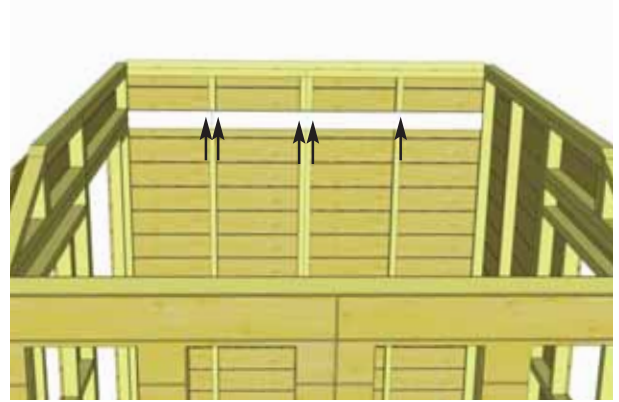
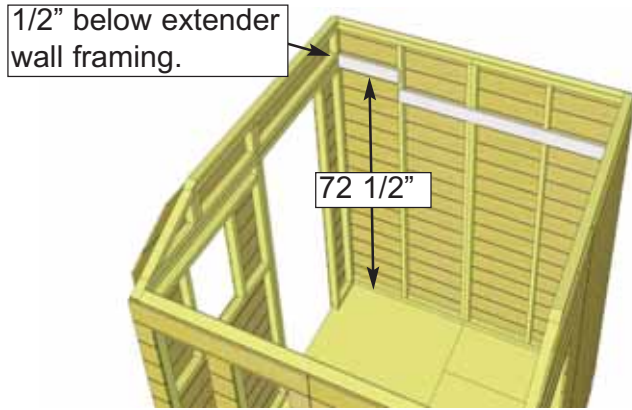

29. Attach **Horizontal Wall Extender Braces** (3/4" x 3 1/2" x 20 1/4"/65 3/4") to Framing of Side Walls on the high side to further secure walls together. Position 72 1/2" up from floor or 1/2" below extender wall framing. Fasten each piece to wall studs as illustrated above using 5 - 1 1/4" screws.

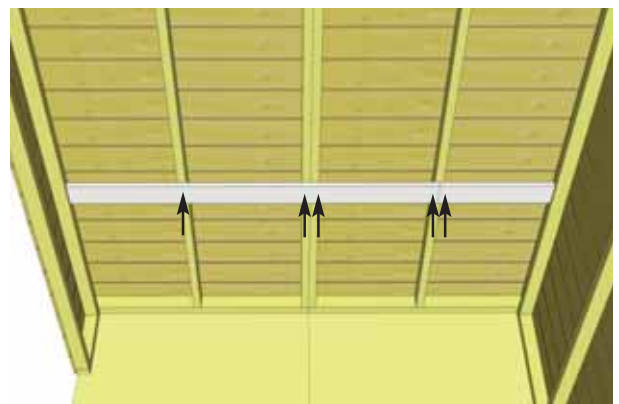
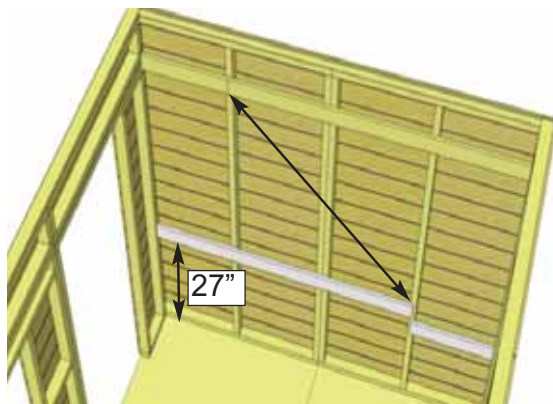

30. Repeat Step 29 but attach Horizontal Extender Wall Braces (3/4" x 3 1/2" x 20 1/4"/65 3/4") to lower part of walls approximately 27" up from the floor but offset the seams from previous braces. Attach with 5 - 1 1/4" screws.

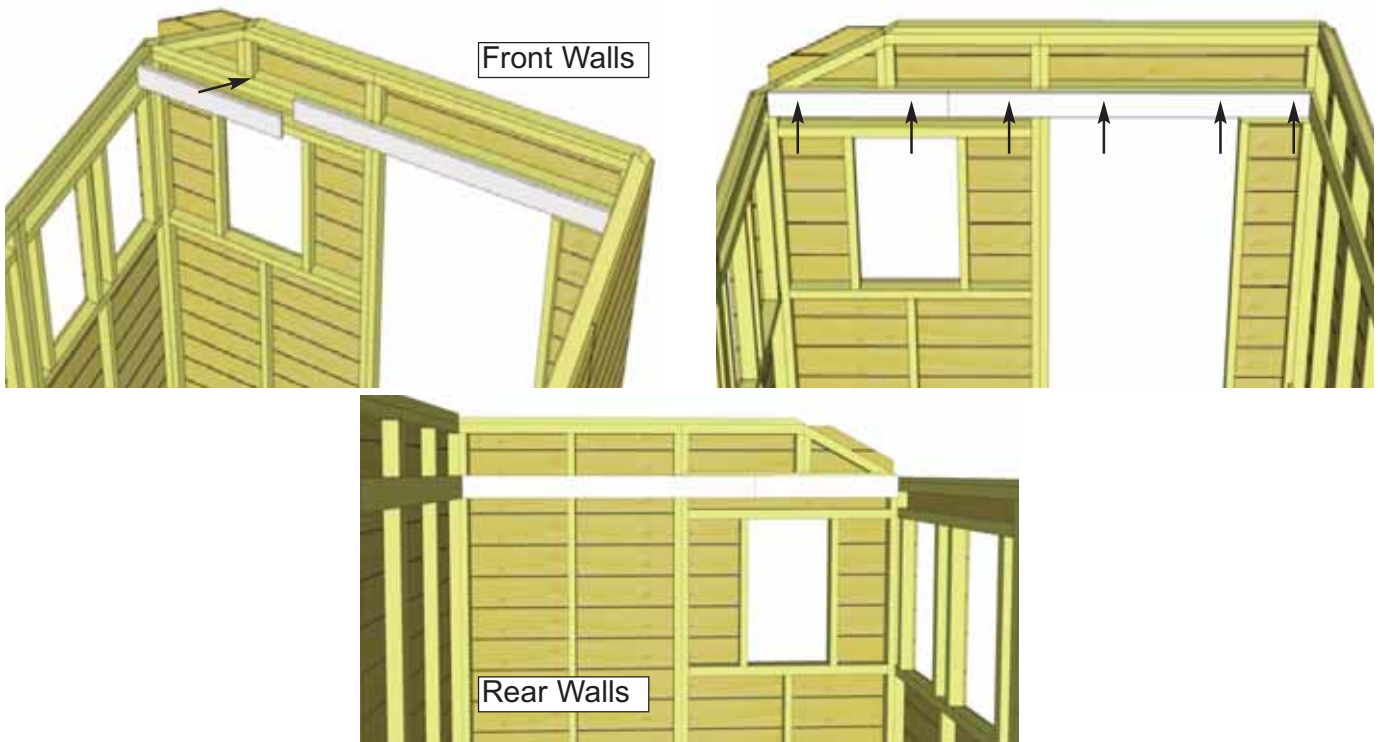

31. Attach **Horizontal Wall Extender Braces** (3/4" x 3 1/2" x 30"/60") to front and rear walls 1/2" below extender wall framing. Complete Front and Rear walls (60" and 30" long pieces) using the same alignment. Fasten with 6 - 1 1/4" screws.

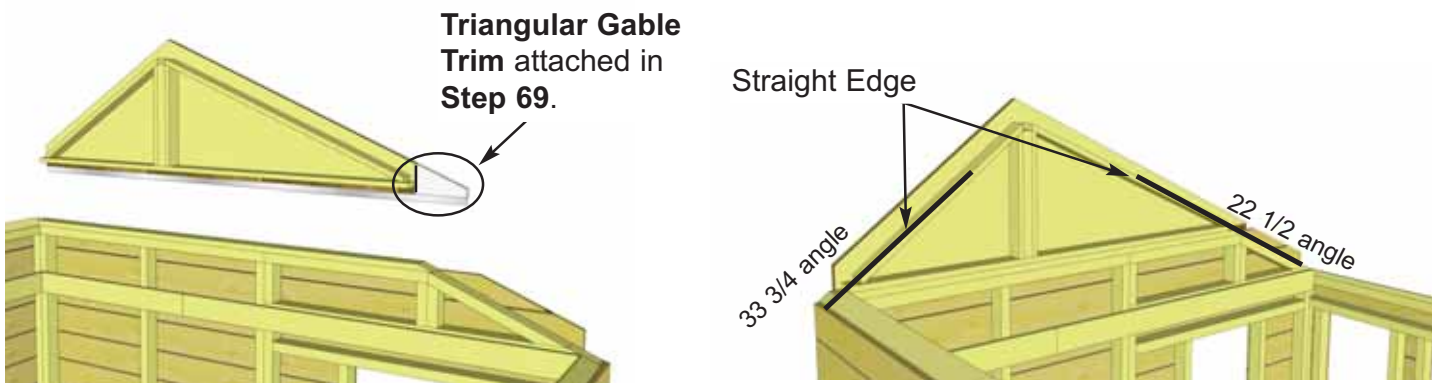

32. Lift up **Gable Wall** and place on top of rear wall. Gable side with 33 3/4" degree cut will align with solid wall. Slide Gable Wall side to side and use a straight edge to line up angled framing of gable with Top Plates and Wall. There is some tolerance, try for best fit on both sides.

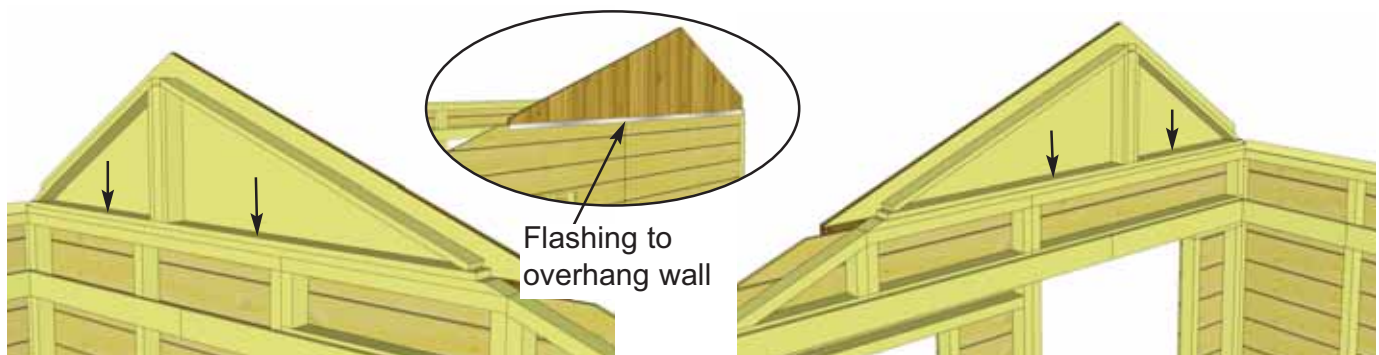

33. When Gable wall is positioned correctly, tack in place with 2 - 2" screws. Adjustment to Gable may be required in **Step 42**. Complete other Gable Wall.

C. Rafter Section

Long Roof Side

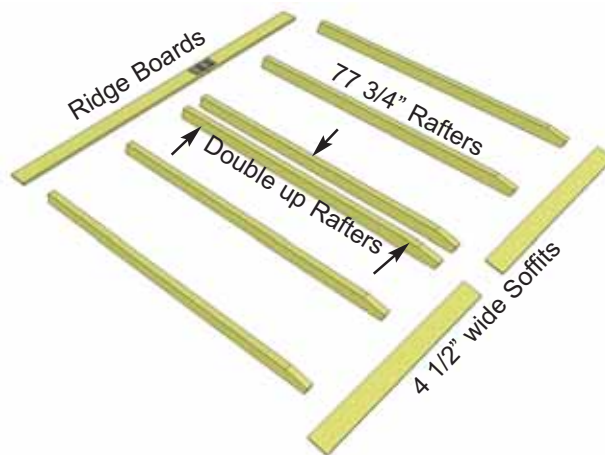
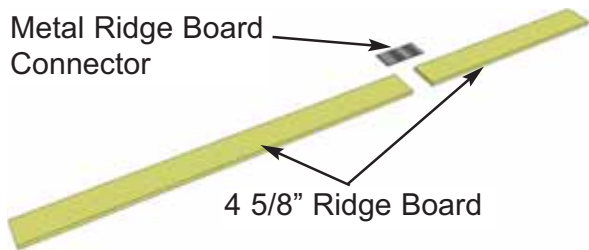

34. Starting with **LONG ROOF SIDE**, locate 2 **Ridge Boards** (3/4" x 4 5/8" x 33 1/2" and 3/4" x 4 5/8" x 57 1/2"). Attach together with **Metal Ridge Board Connector** using 8 - 3/4" screws. Locate 6 - 1 1/2" x 3 1/2" x 77 3/4" **Rafters** and 2 - 1/2" x 4 1/2" x 45 1/2" **Soffits** and lay out on a flat level surface as pictured. Screw doubled up rafters together with 3 - 2 1/2" screws. **Note: Soffits for long roof side are 4 1/2" wide, short roof side are 3 1/2"**.

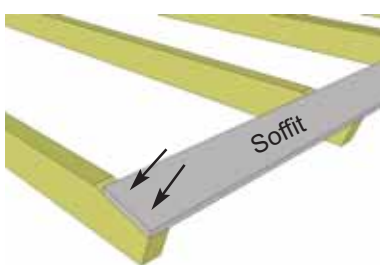

Important: Pilot Hole Ridge Board and Soffit to prevent splitting!

Important: Ridge Board must be aligned to bottom of rafter end in this position.

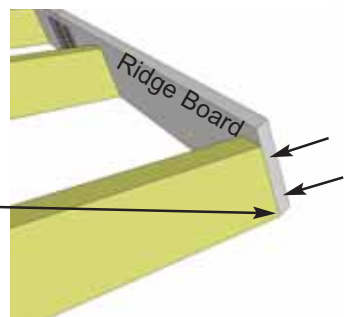

35. Attach end of a 45 1/2" long Soffit Board flush to ends of outside rafter with 2 - 1 1/4" screws per rafter end. Drill pilot hole in Soffit to prevent splitting. Attach Ridge Board to opposite rafter end, aligning to bottom of rafter, with 2 - 1 1/4" screws. Center Soffit on Middle Rafter and secure with 2 - 1 1/4" screws. Measure 45 1/2" from outside rafter and secure Ridge Board to rafter with 2 - 1 1/4" screws.

Important: Measure 20 1/2" spacing accurately to accommodate Polygal Panels in **Step 56**.

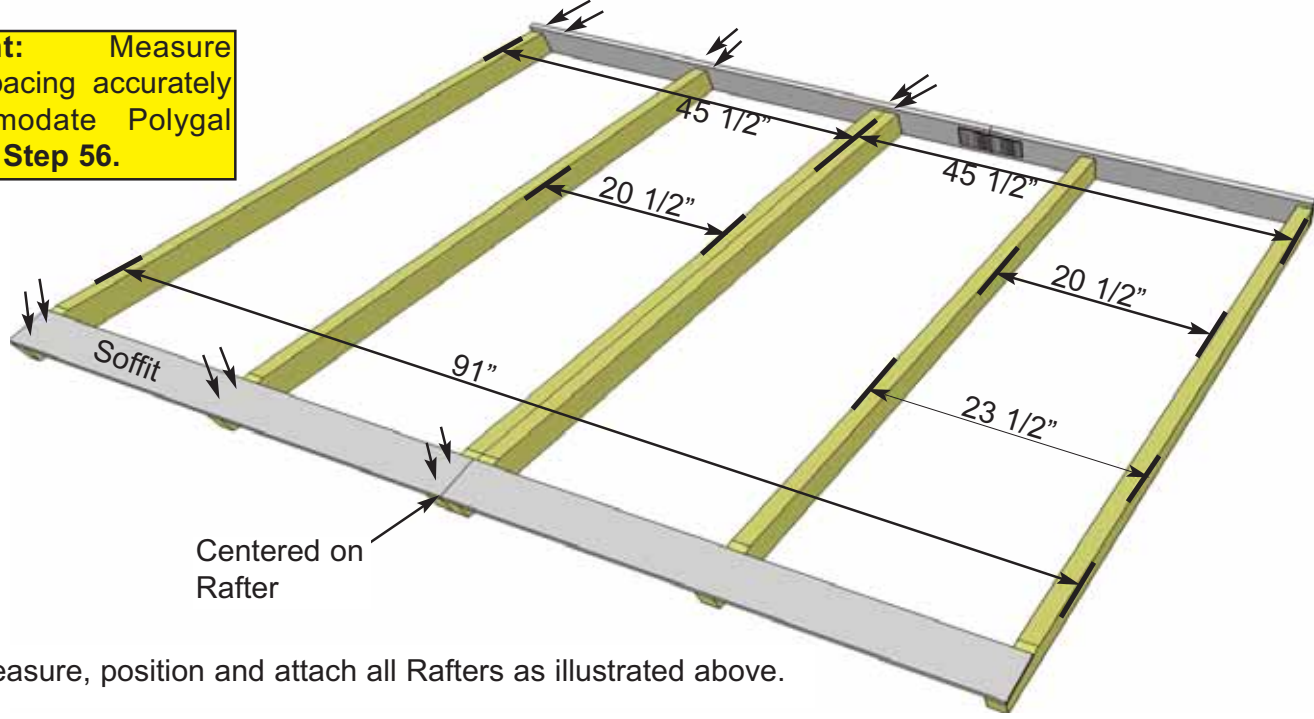

36. Measure, position and attach all Rafters as illustrated above.

Short Roof Side

- 37.** Complete **Short Roof Side Rafter Section** as per **Steps 34 - 36** with the following exceptions:
 Rafters length = **37 3/4" long**
 Soffit width = **3 1/2" wide**
 Ridge Board = **5 1/8" wide**

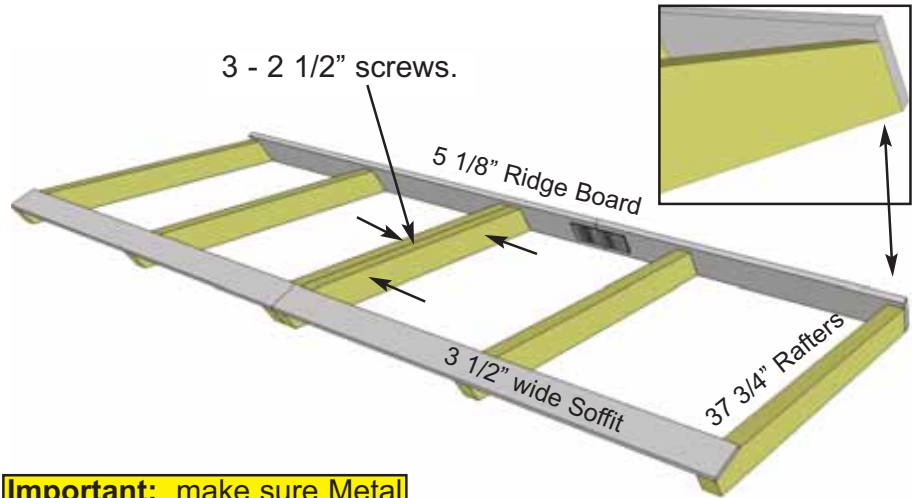

Important: make sure Metal Ridge Board Connectors on Long Roof side and Short Roof side are offset. See **Diagram Step 41.**

Slide Bottom of Ridge Board into notch of gable.

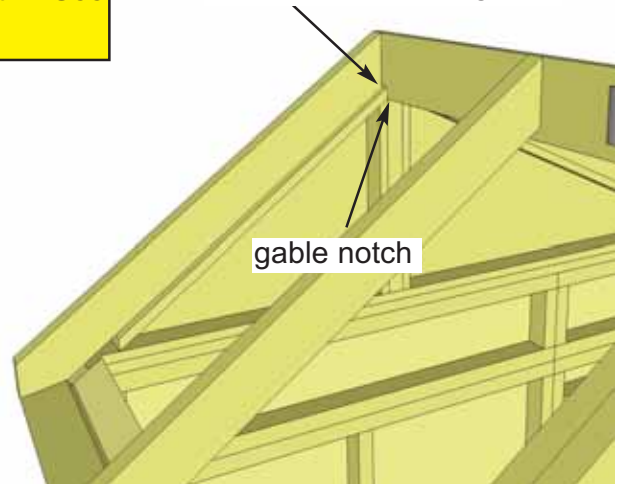
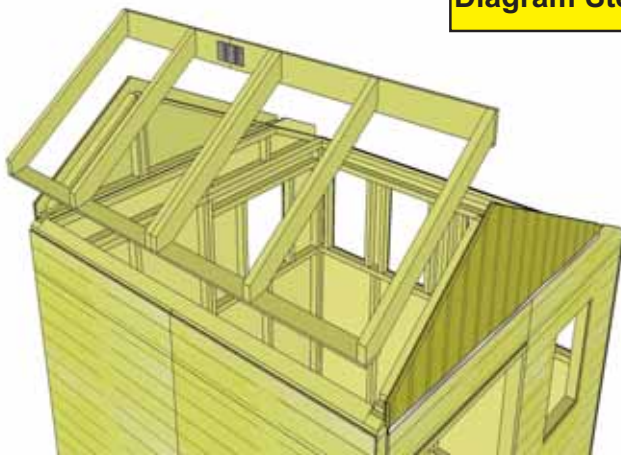

- 38.** Starting with the Short Roof Side, lift and flip completed Rafter section over with Soffit now facing down. Slide rafter up on gable framing until bottom of Ridge Board slips into gable notch. Position rafters so they sit evenly on Gable framing from side to side.

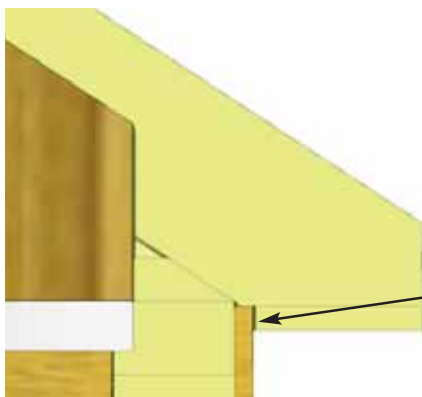

Soffit should sit approx. 1/8" away from wall panel.

- 39.** Where Wall and Soffit meet, a small gap may appear. Confirm all Rafters are resting on Top Plate.

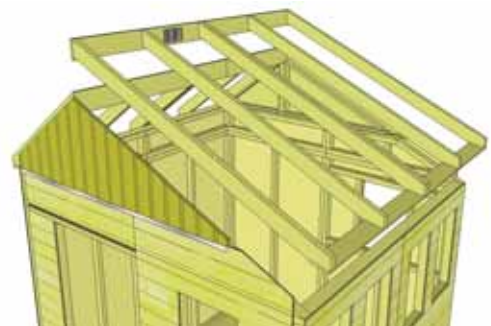

- 40.** Lift and flip Long Rafter Side up and place on Gable framing. **Make sure Metal Ridge Board Connectors of both Roof Sections are offset.** See **Diagram Step 41.**

Short Roof side Ridge Board extends 1/2" past.

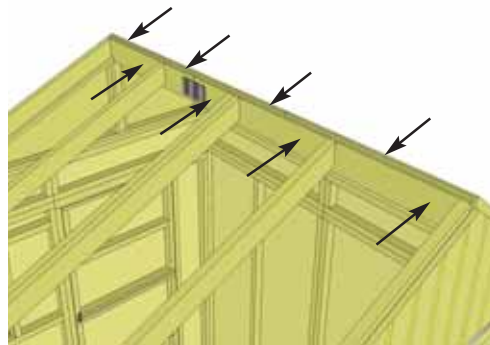

Ridge Board Connectors

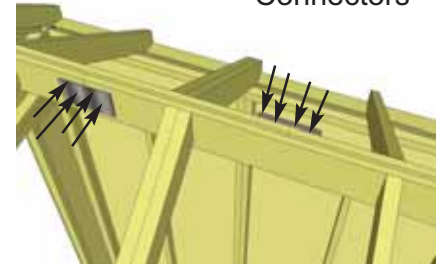

41. Slide Long Rafter Section on Gable framing so bottom of ridge board slips into Gable notch. At the peak, align Ridge Boards so they are tight together and secure them with 8 - 1 1/4" screws. **Important:** if there is a gap between Ridge Boards, have two helpers push side walls closer together from outside. To completely secure Ridge Boards, place 4 - 1 1/4" screws into any of the remaining Metal Ridge Board Connector's holes.

Important: If Gable framing does not line up with Rafters, remove temporary 2" screws from gable framing (**Step 33**). Re-align gable and secure with 7 - 2" screws into top plate.

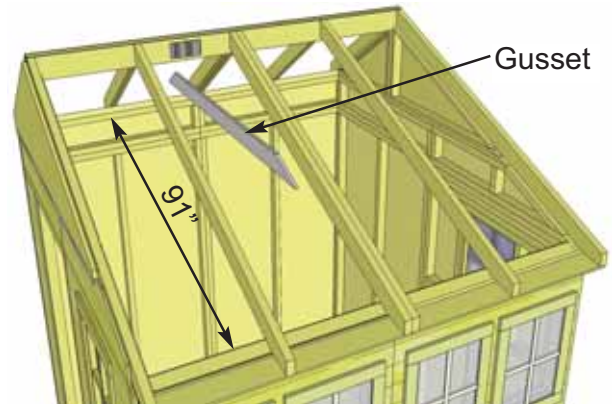
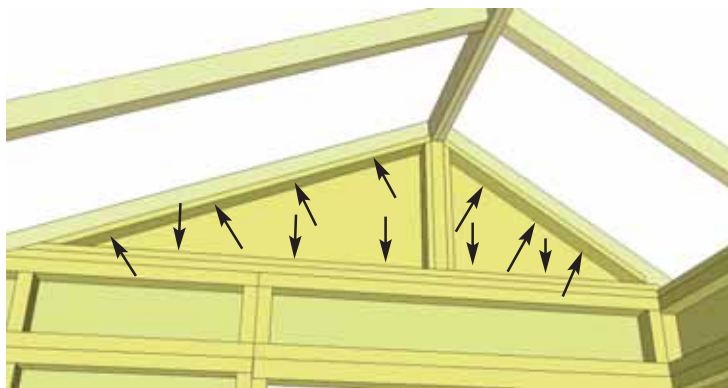

42. With both Short and Long Roof Side Rafters in correct alignment, secure Gable framing to both outside rafters with 7 - 2" screws per side at top and with 5 additional 2" screws into wall top plates at bottom. Prior to attaching **Gussets** (3 @ 3/4" x 3 1/2" x 72"), make sure walls are aligned correctly. Have two helpers push on side walls from the outside until the distance between the inside of the top plates is 91".

Leave 1" gap from top of rafter

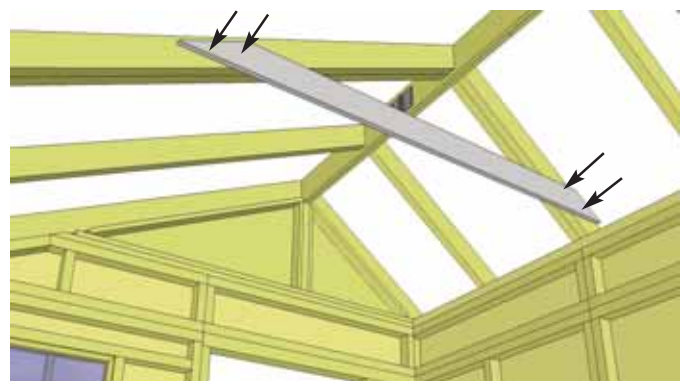
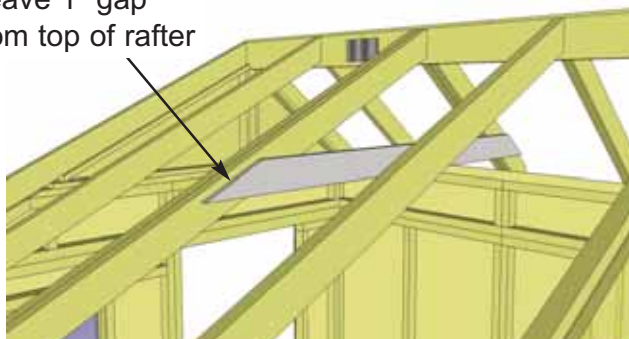

43. With walls correctly positioned, attach Gusset to Rafter with 4 - 2" screws. Use a level to check that it is square.

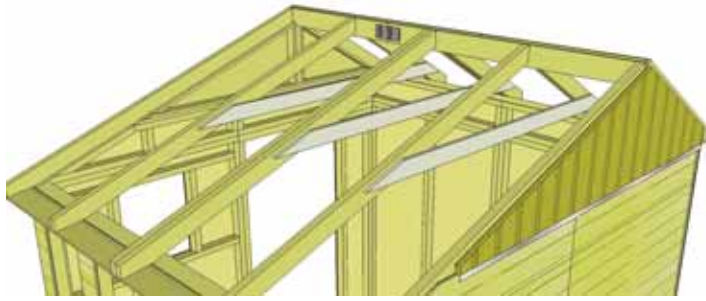

44. Complete installation of remaining Gussets.

Rafter Brackets are bent to 22 and 33 deg. Use correct bracket for each side.



Important: Drill pilot holes to prevent splitting!

45. Attach all **Single** and **Double Rafter Brackets** where rafters meet Top Wall Plates inside of shed. Attach with 2 - 1 1/4" screws and 2 - 2" screws per Single Rafter Bracket and 6 - 2" screws per Double Rafter Bracket.

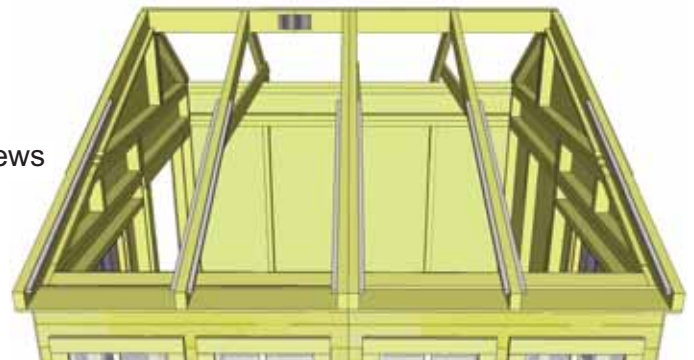
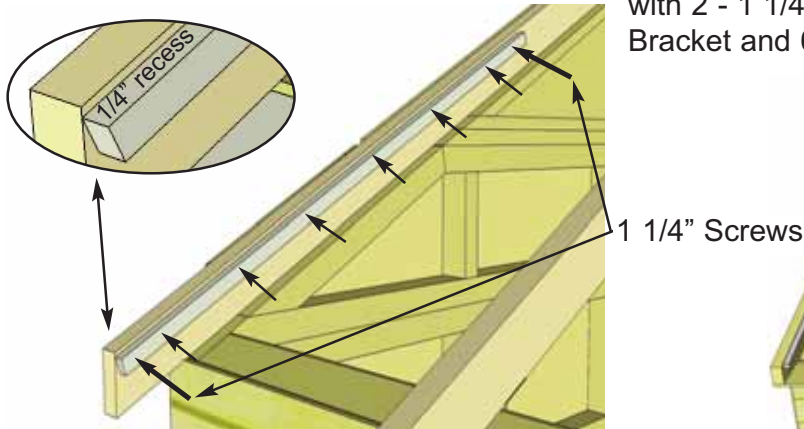

46. Position a **Polygal Support Cleat** (3/4" x 3/4" x 44 1/2") on a Long Rafter flush to end and recessed 1/4" down from edge of rafter. Nail to rafter using 6 - 1 1/2" finishing nails. Further secure Cleats with 2 - 1 1/4" screws. **Note:** Start nails in Cleat on ground first. Complete remaining 7 Polygal Support Cleats.

D. Roof Section

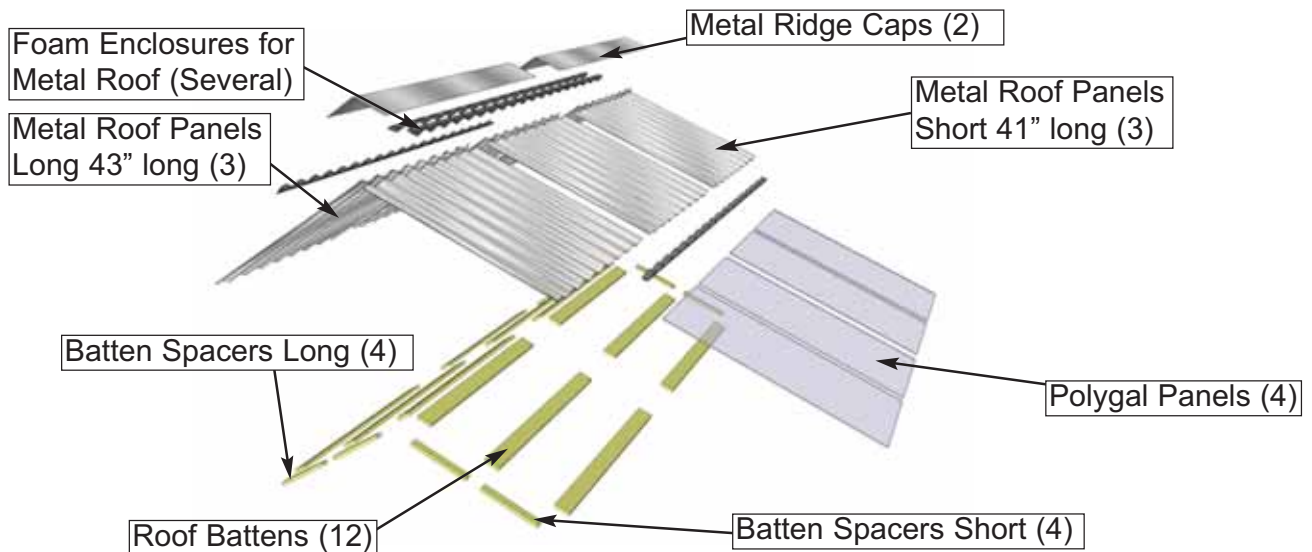

Batten flush with Ridge Board

Centered on 3rd Rafter

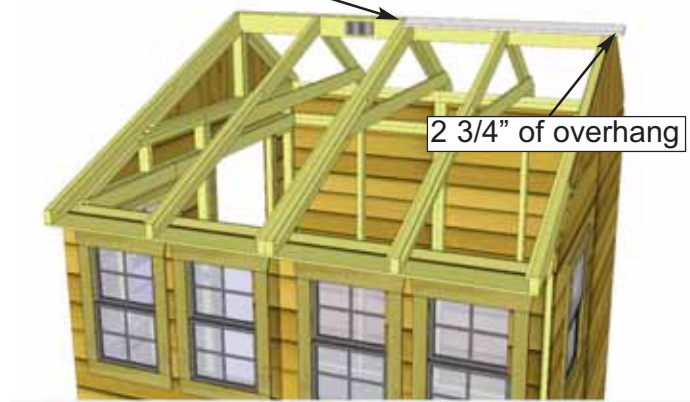
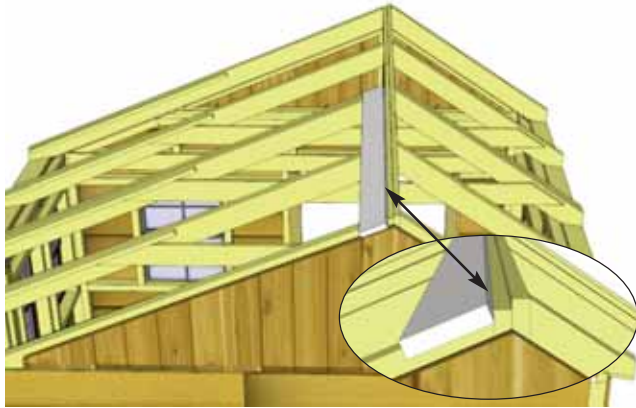

47. Starting on the polygal side, locate one **Roof Battens** and place on Roof Rafters where Rafters and Ridge Boards meet. Batten should be positioned evenly on 3rd Rafter. Batten will overhang outside Rafter by 2 3/4".

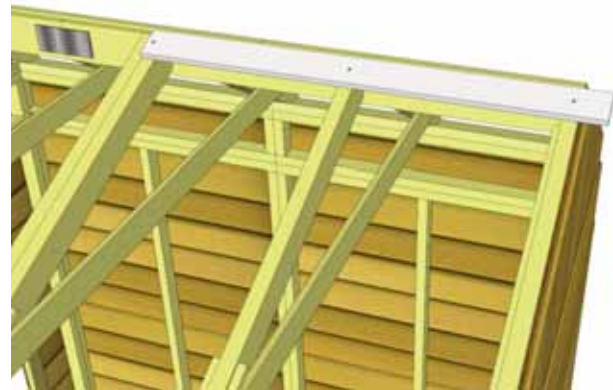
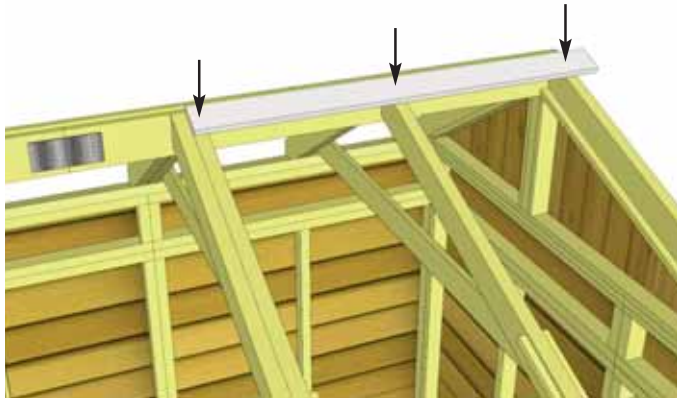

48. Attach Batten to Rafters with **3 - 1 1/4" screws** (1 per Rafter). **Important:** pre-drill pilot holes with 1/8" drill bit first to prevent splitting.



49. Locate **Roof Batten** and place on Roof Rafters next to previous Batten. Attach with **3 - 1 1/4" screws**.

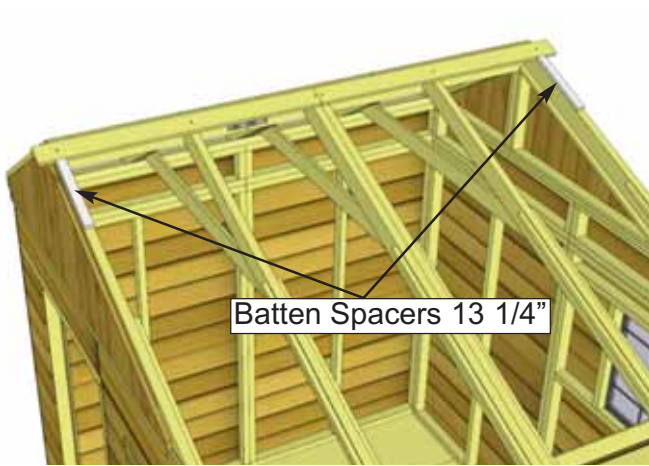

50. Locate 2 **Batten Spacers Short** ($3/4'' \times 1\ 1/2'' \times 13\ 1/4''$). Place 1 Batten Spacer below each Batten lengthwise along outside Rafter. Attach each Spacer to outside Rafter with **2 - $1\ 1/4''$ screws** per spacer (4 total).

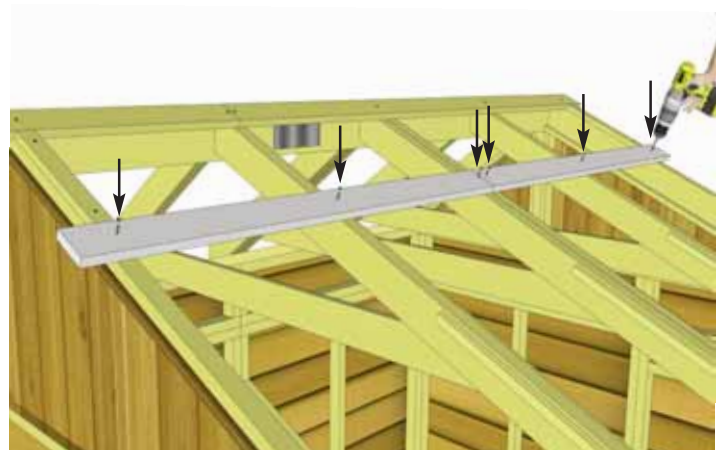

51. Locate 2 **Roof Battens Center** ($3/4'' \times 3\ 1/2'' \times 48\ 1/4''$). Place Battens flush to Batten Spacers and overhanging outside Rafter by $2\ 3/4''$. Attach each Batten to Rafters with **3 - $1\ 1/4''$ screws** (6 total).



52. Locate 2 more **Batten Spacers Short** ($3/4'' \times 1\ 1/2'' \times 13\ 1/4''$). Place Batten Spacers flush to 2nd row of Roof Battens. Attach each spacer to outside Rafter with **2 - $1\ 1/4''$ screws** (4 total).



53. Locate 2 more **Roof Battens**. Place Battens flush to 2nd row of Batten Spacers. Attach **Roof Battens** with 3 - 1 1/4" screws each.

Non-Polygal Side

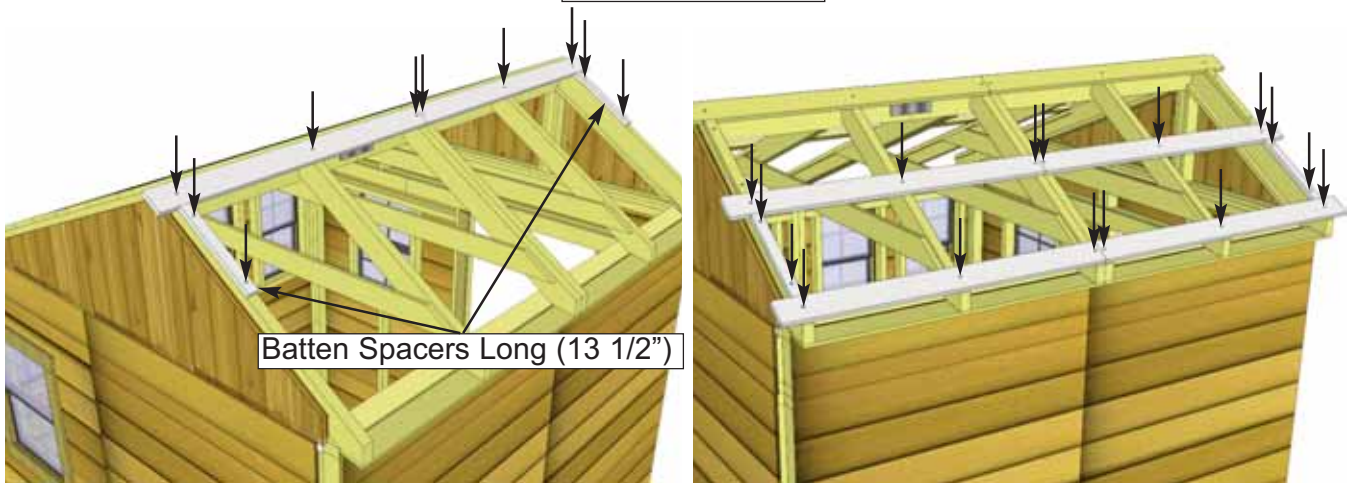

54. Switch to non-polygal side of roof. Attach 2 **Roof Battens** to peak of Roof as per **Steps 47 - 49**. Repeat **Steps 50 - 53** with **Batten Spacers Long (3/4" x 1 1/2" x 13 1/2")** to attach remaining Battens and Batten Spacers.

Completed Batten Section



Important: Do not fasten down Roof Panels with Hangers still in place. Metal Roof Hangers will temporarily help keep Metal Roof Panels in place before they are fastened.

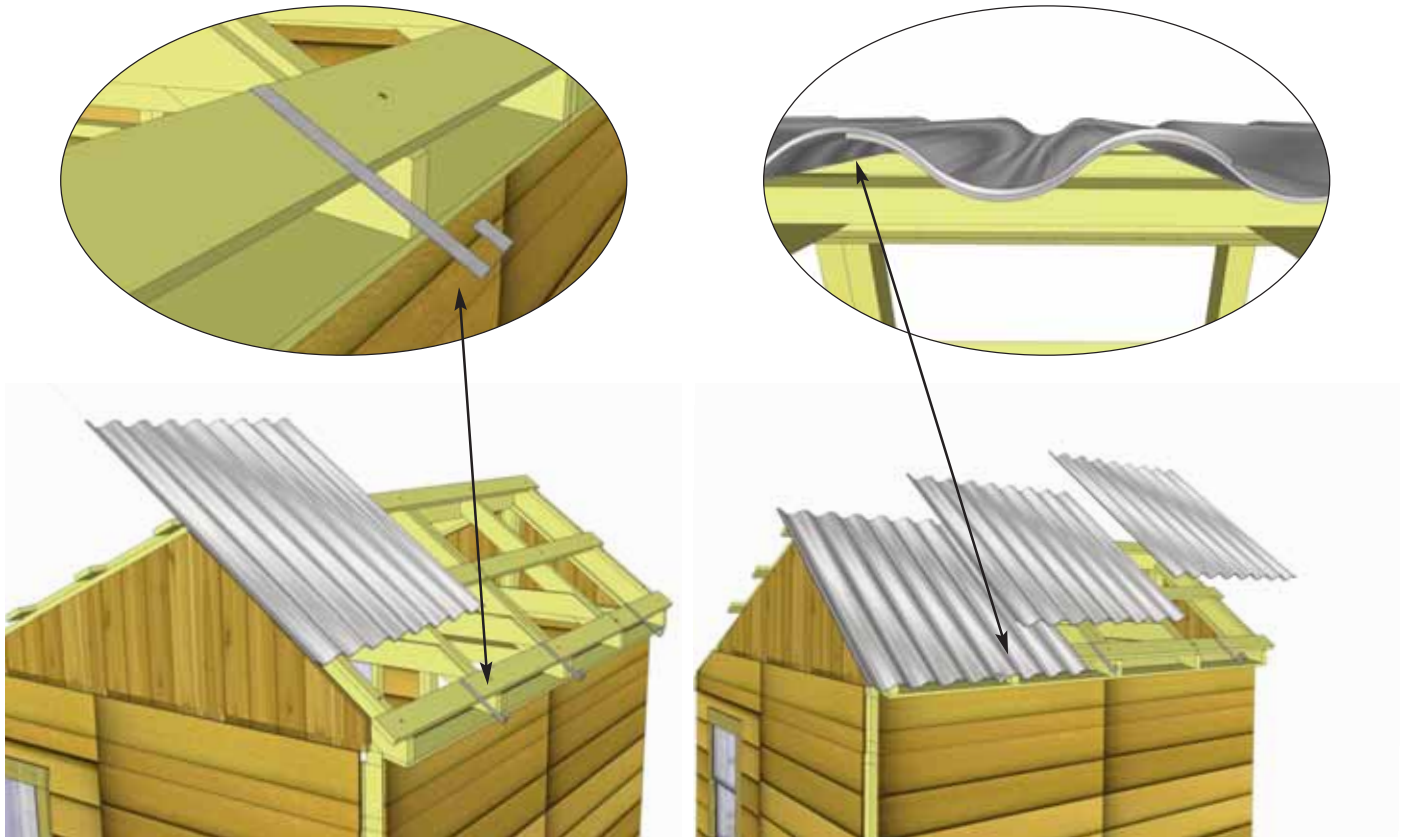

55. Starting on the short roof side, locate 3 **Long Metal Roof Panels (39" wide x 43" long)** and 3 **Metal Roof Hangers**. To temporarily hold the Metal Roof Panels in place, hook a Metal Roof Hanger onto lowest Batten approximately where the center of the first panel will be. Place the first Metal Roof Panel on Battens and into Hanger. Do not fasten Panels down until **Step 60**. Place remaining 2 panels and Hangers on the same way. Metal Roof panels will overlap each other.

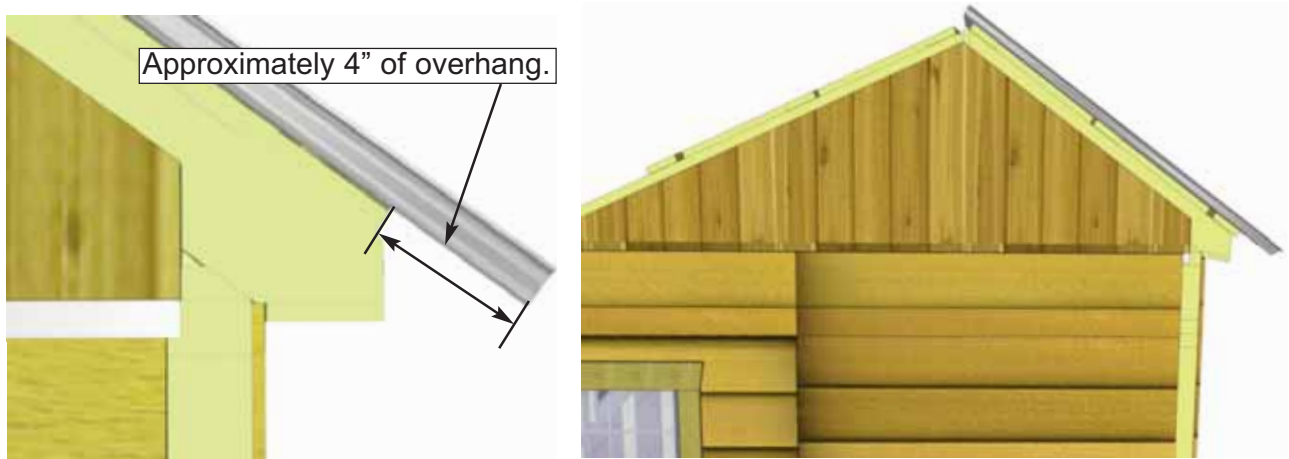

56. Overhang the **Metal Roof Panels** past the Battens on sides by approximately 1". Adjust panels side to side to achieve desired width. Overall width past the Battens can vary from 1" - 3" depending on your preference. The overhang over the side of the shed will be set by the **Metal Roof Hangers**, but should be approximately 4" on the side of shed.

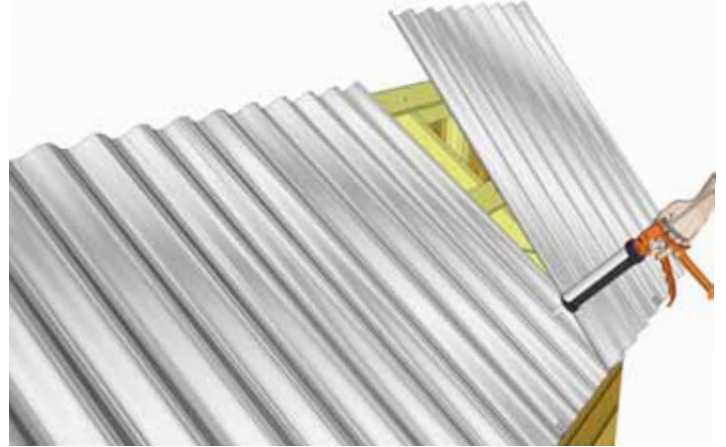

57. Once Metal Roof Panels are spaced correctly from side-to-side and top-to-bottom, lift 2 panels up and run a bead of caulking down the overlapping seams of each panel to seal the joints. Place panels down one by one once seam is caulked. You will likely need assistance from a helper for this step. Caulk each seam.

Important: Metal Roof Hangers will be removed in **Step 59.**

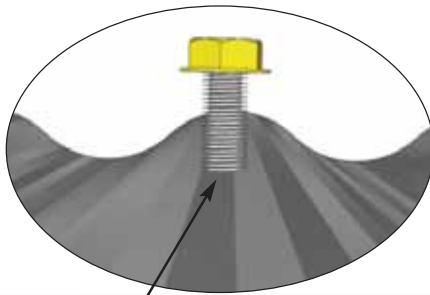

Screw into peaks of Roof Panels not valleys.

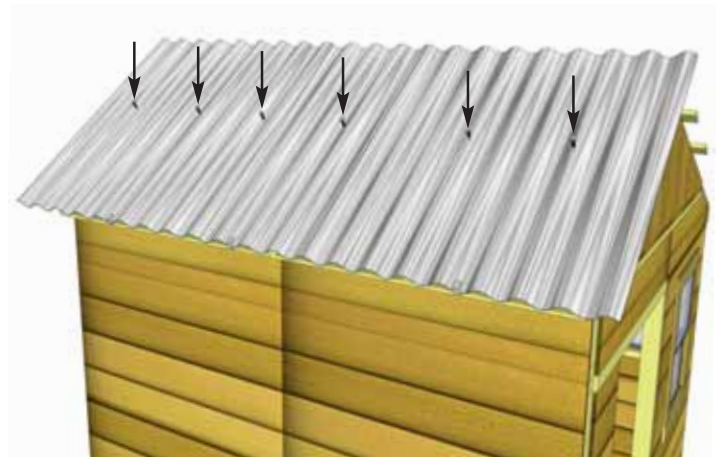
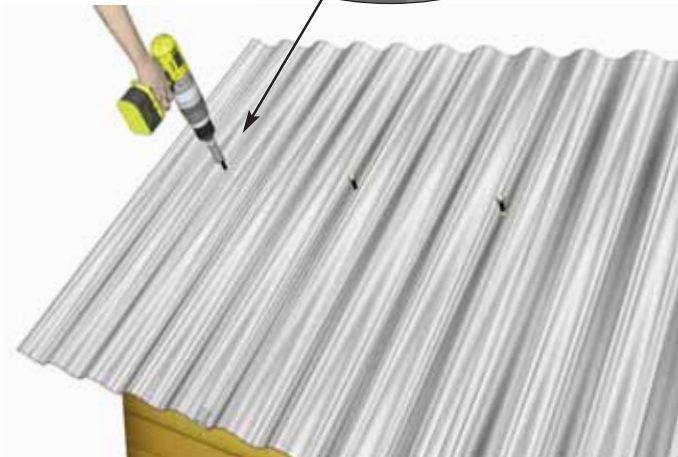

58. Using **6 - 2" Metal Screws** and **1/4" Nut Driver** (included), partially secure Metal Roof Panels down to middle Batten row. Only fasten screws halfway so that Metal Roof Hangers can be removed. Metal screw is self-tapping, screw into center of Battens. Twelve more **2" Metal Screws** will be required to further secure **Metal Roof Panels** and to complete **Metal Ridge Caps** later once Metal Roof Hangers have been removed. Screw into peaks of Metal Roof panels and not the valleys. **Do not fully tighten!**

Important: Remove Metal Roof Hangers

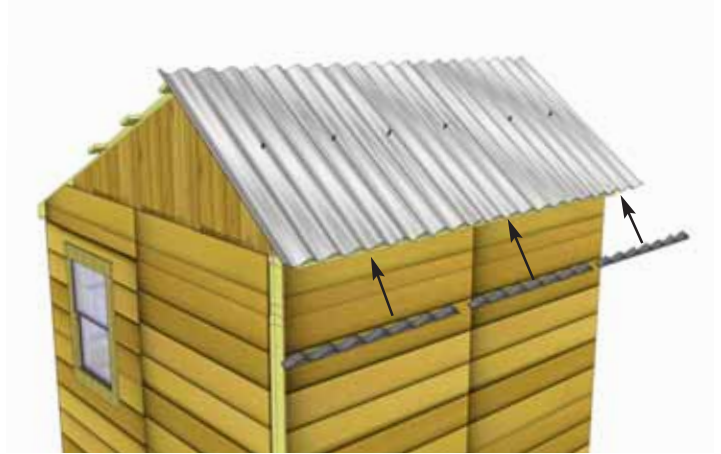
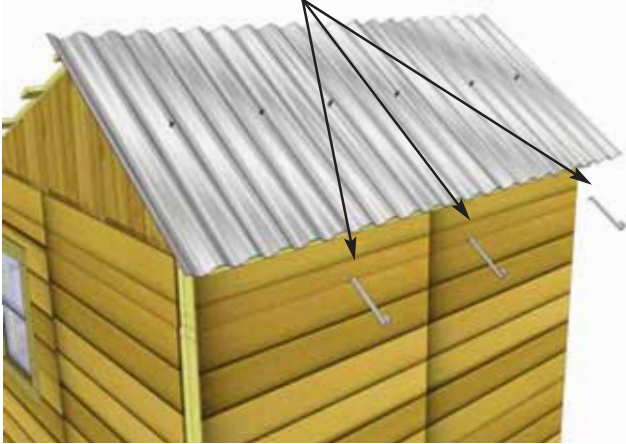

59. Before fully fastening **Metal Roof Panels** down, remove **Metal Roof Hangers** and insert **Foam Enclosures** between **Metal Roof Panels** and **Battens** at the bottom of the roof. Enclosures will prevent moisture and unwanted bugs, etc from entering your shed through here.

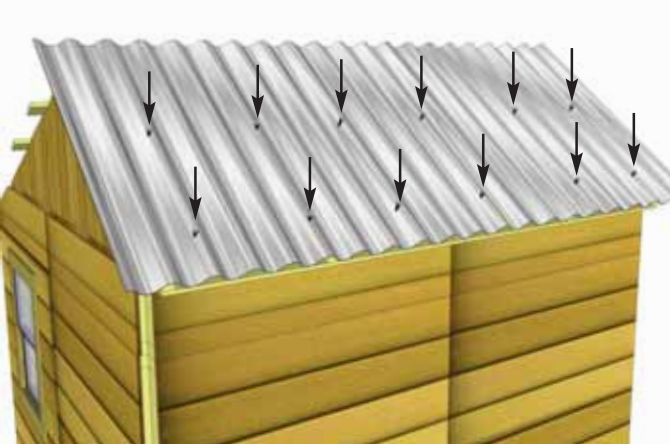

60. Using **6 - 2" Metal Screws** and 1/4" Nut Driver, secure **Metal Roof Panels** down to remaining lowest row of Battens. Leave the top row unsecured for now to secure Metal Ridge Caps in **Step 64**. Tighten screws in middle row that were partially secured in **Step 58**. Do not overtighten!

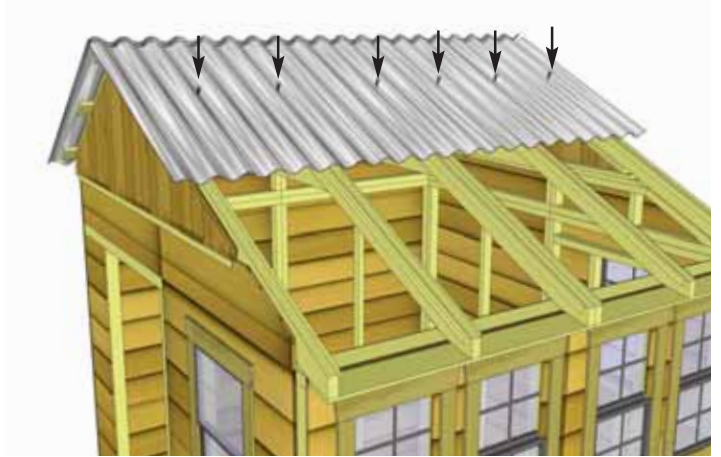
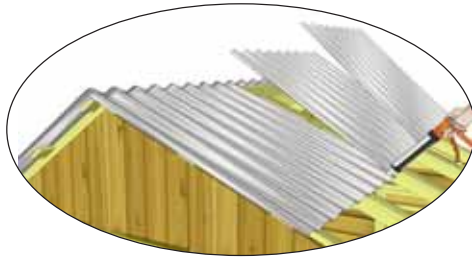

61. Move to polygal side of roof and locate **Metal Roof Panels Short (39" wide x 41" long)**. Space panels apart as per **Step 56** to match opposite side. **Short Metal Roof Panels** will overhang lowest Batten by approximately 3". Caulk seams between panels before fastening. Attach Panels to Middle row of Battens with **6 - 2" Metal Screws**. **Note:** Metal Hangers do not set length of short panel side. Use a helper to hold the short panels in place. It may also help to work from inside the shed.

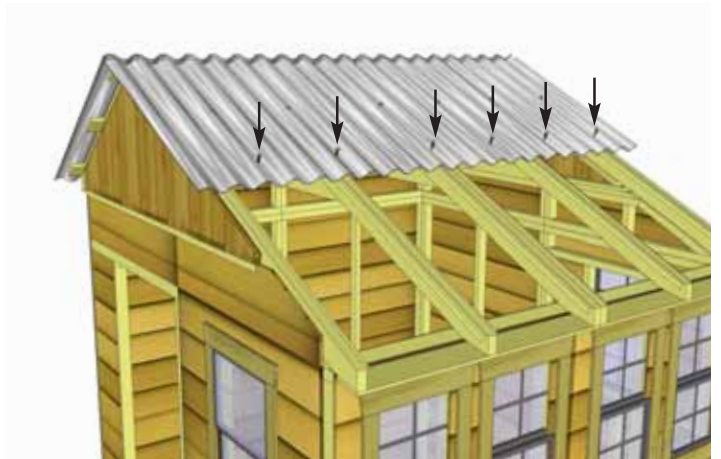
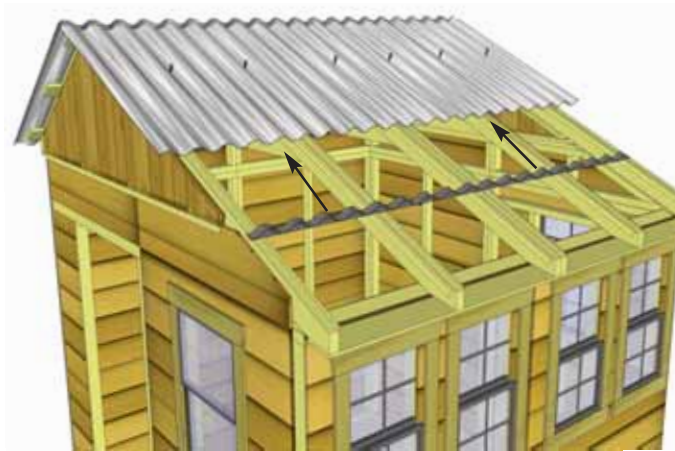

62. Locate **Foam Enclosures for Metal Roof**. Insert Foam Enclosures between lowest Batten and Metal Roof. Attach Roof Panels to lowest Batten with **6 - 2" Metal Screws**.



63. Locate remaining **Foam Enclosures for Metal Roof** and **Metal Ridge Caps (60" long)**. Place Foam Enclosures at the peak of roof panels. Foam Enclosures prevent moisture from coming in through the top of your shed. Place **2 - Metal Ridge Caps** onto apex of roof. Evenly space from front to rear of shed. Ridge Caps will overlap each other. Overhang the caps approximately 1" - 2" past each end depending on your preference.

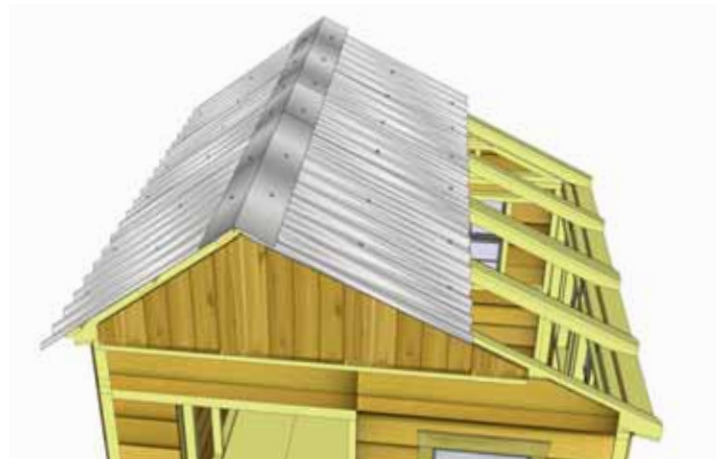

64. When Ridge Caps are correctly positioned, secure with **12 - 2" Metal Screws** (6 per side). Screw into final Batten. Screw through both Ridge Caps and Roof Panels, into Batten. Do not overtighten!

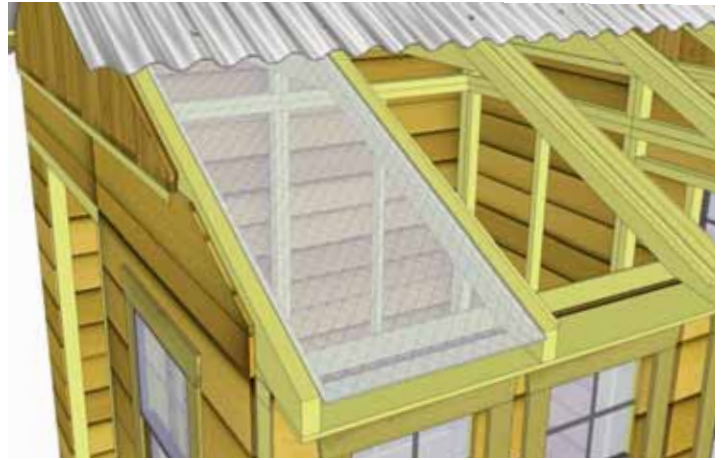
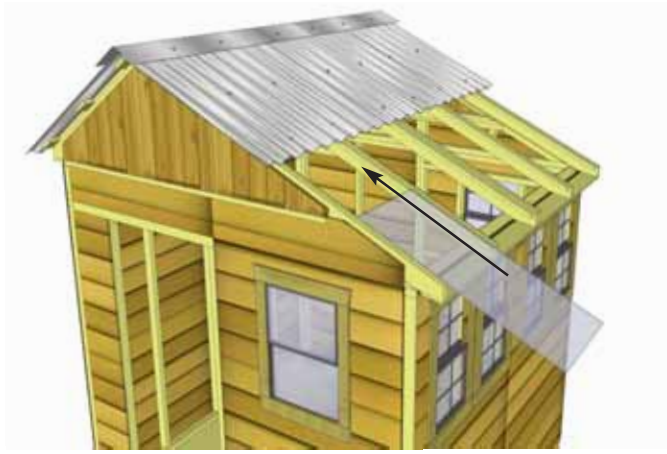

65. Installation of 4 **Polygal Panels** is next. Start by removing protective plastic layer from each panel. Exterior/interior side of protective polygal film is printed on film, be sure to note the side and install accordingly. Slide panel up between rafters so it rests on **Polygal Support Cleats**. From the inside, carefully slide end of **Polygal Panel** underneath roof. Position **Polygal Panel** equally between rafters and overhanging end of rafter by 1”.

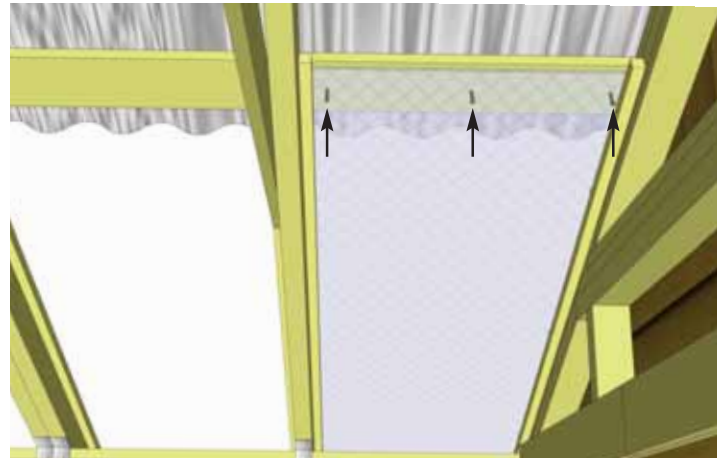

66. Drill pilot holes with 1/8” bit through **Polygal Panel** and **Polygal Support Cleat** once aligned. With **6 - 1” screws**, secure panel to **Polygal Support Cleats**. Polygal is delicate, tighten screws a half turn at a time so screws are flush with top of **Polygal Panel**. Use **3 - 1” screws** to secure **Polygal Panel** to underside of **Roof Batten**.

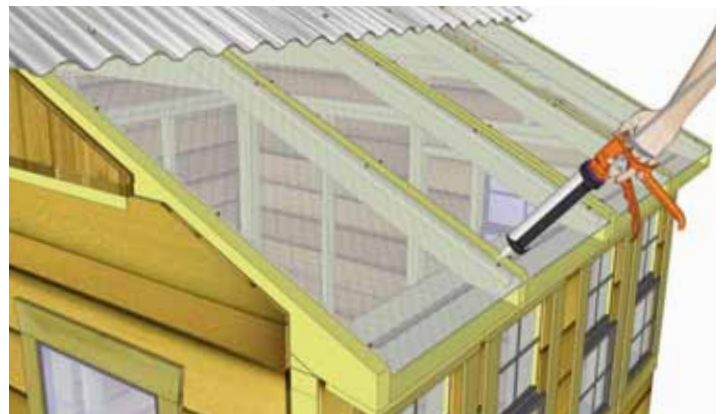

67. Position and secure remaining **Polygal Panels** as per **Steps 65 - 66**. With a caulking gun, apply silicone to seal gaps between Rafters and Polygal Panels. Apply silicon down each side of Rafter. Use liberal amounts to properly seal. Silicone will be covered by **Polygal Ridge Caps** in **Step 78**.

E. Miscellaneous Section

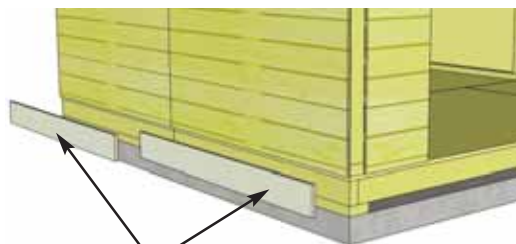

2 pieces of Bottom Skirting per side

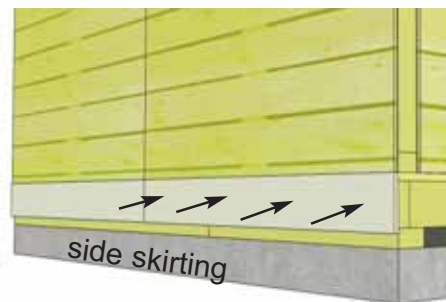

side skirting

68. Attach **Bottom Skirting** (8 @ 1/2" x 4 1/2" x 45 1/4") around the base of the shed. Skirting will hide floor framing. Gaps in corners will be covered by Wide Trim pieces later. Start with side pieces first and attach with 4 - 1 1/2" finishing nails per piece.



Gap in corner



Caulking

Optional: Caulking seams will help prevent moisture from entering your shed. Caulking is included to complete Polygal Windows only. Additional Caulking may be required.

Note: Triangular Gable Trim is located inside gable corner behind scrap piece marked with "X"



Determine vertical location of trim by using horizontal Gable Trim as a guide. See Step 82.

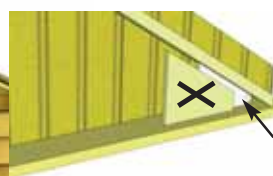

Triangular Gable Trim

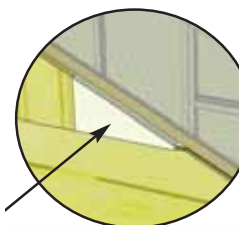

69. Position 2 **Door Trims** (2 - 1/2" x 2 1/2" x 87") on each side of door opening. Right side will sit flush with Door Jamb. Left side will sit flush on edge of Narrow wall. Do a dry run with the Horizontal Gable Trim (**Step 89**) to determine vertical height of Trims. Attach with 8 - 1 1/2" finishing nails each. Position **Triangular Gable Trim** over exposed cavity of Gable Wall on Long Roof Side. Use 2 finishing nails to secure into rafter. Complete for both front and rear.

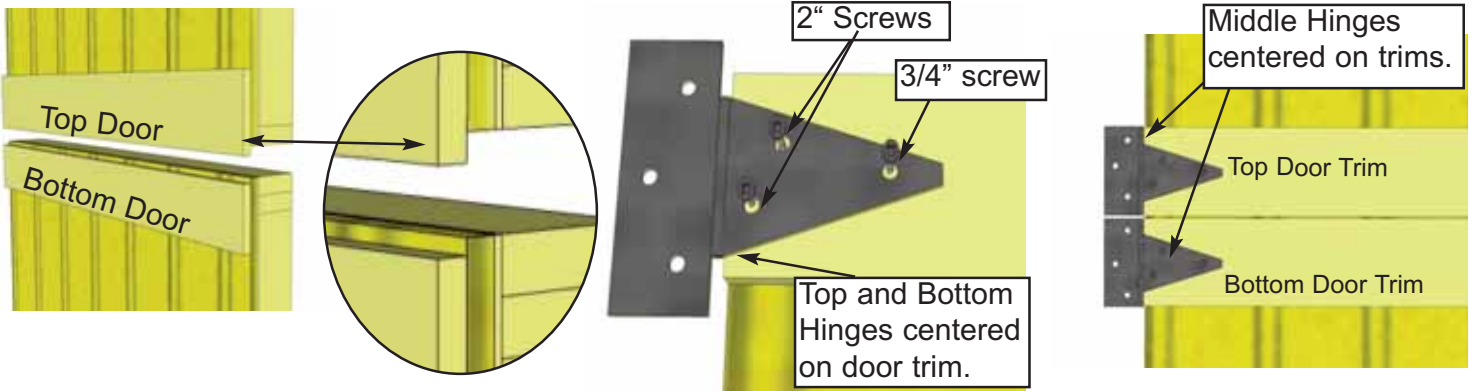

70. Attach Door Hinges to **Top** and **Bottom Dutch Door** sections. Top Door has trim overhanging door at bottom while bottom door has trim recessed slightly. Hinges should be centered on door trim with barrel nudged to end of trim. Use 2" & 3/4" black headed screws as shown above.

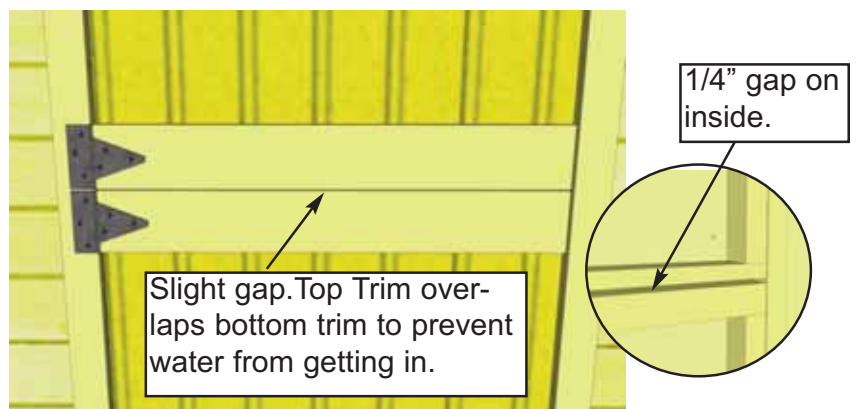
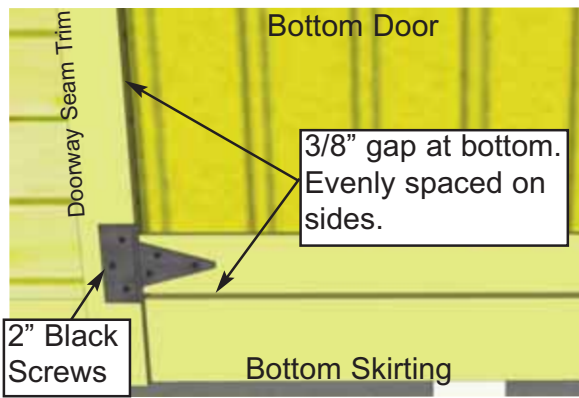

71. Place Bottom Dutch Door panel into position. Gap 3/8" on bottom, evenly space on sides, and attach hinge to doorway seam trim with 2" black headed screws. Use shim to help keep the door evenly spaced on bottom. One of the extra roof shingles (see parts list) can be used.

72. Place the Top Dutch Door Panel into place and gap top and bottom trims on the outside about 1/8" apart. On the inside, horizontal door frames should be about 1/4" apart. Use a shim once again to help you. Attach hinges to trim with 2" black headed screws provided.



Temporarily positioned Interior Door Stop to help align Interior Barrel Bolt.

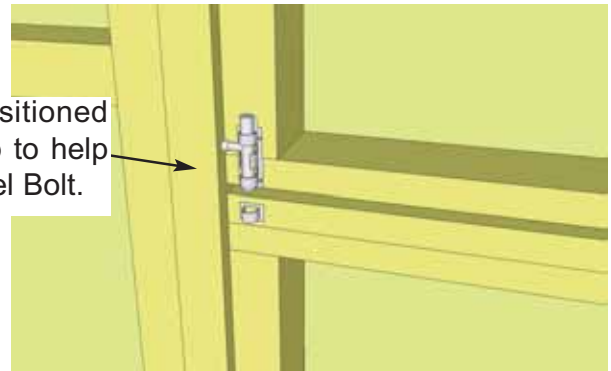

73. Attach **Door Handle**, **Drop Latch** and **Interior Barrel Bolt** to door. Handle is positioned on top door, Drop Latch on bottom door and Interior Barrel Bolt (silver) to top door stud. Attach Drop Latch as illustrated above with 3/4" Black Screws. Note how female part of Drop Latch is positioned higher than male. Do a dry run first to position Drop Latch correctly. **Important:** Drill pilot holes with 1/8" drill bit prior to securing with screws to prevent wood splitting.

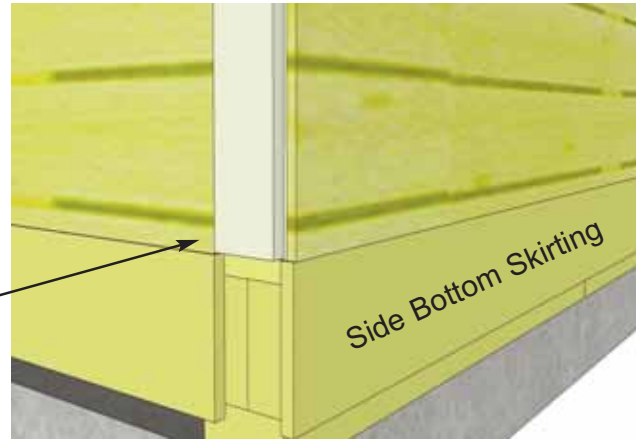

74. Attach **Filler Trim - Tall and Short** (2 - 5/8" x 2 1/2" x 75" & 2 - 84") to front and rear walls in each corner with 6 - 1 1/2" finishing nails. Strips are positioned flush with siding and bottom skirting.

75. Align and attach **Narrow Trims** in each corner. There are 2 Short Wall Trims (1/2" x 2 1/2" x 79"), and 2 Tall Wall Trims (1/2" x 2 1/2" x 88"). Align Trim tight underneath Soffit. Position flush with Filler Trim so Wide Trim will cap it when attached in **Step 76**. Use 8 - 1 1/2" finishing nails to secure each piece. Note that Narrow Trim will sit slightly below Bottom Skirting when correctly attached.

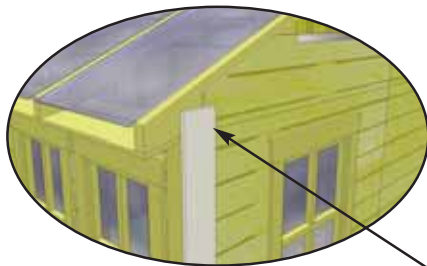

76. Position **Wide Trims** in each corner. There are 2 Short Wall Trims (1/2" x 4 1/2" x 82"), and 2 Tall Wall Trims (1/2" x 4 1/2" x 87"). Align to cover Filler Trim and cap Narrow Trim. Wide Trim will be flush with Narrow Trim at bottom. Secure trim with 8 - 1 1/2" finishing nails. Complete remaining corner trims.

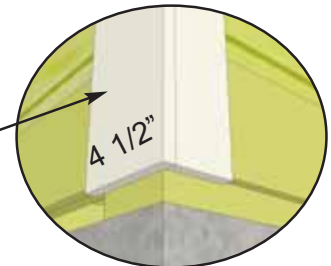
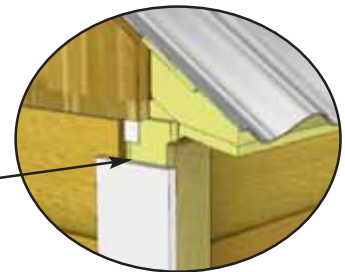



77. Attach remaining **Narrow Wall Trims** around the Sunshed. Narrow trims are used where wall panels come together and leave a seam. **Note:** the Narrow Trim on the Short Wall side is only 79" long. Attach with 8 - 1 1/2" finishing nails per piece. Align Trim flush at bottom with corner trim.



78. Locate all **Ridge Caps** for Polygal Panels (41 1/2" long - 2 Outside / 2 Mid / 1 Center). Starting from the outside, position a 5 1/2" wide cap so outside edge is aligned with batten of roof and Cap end slides under roof until in contact with batten. When correctly aligned, attach Cap to center of outside rafter with 6 - finishing nails. **See below for diagram of alignment.** Outside Ridge Cap has nailing strip attached.

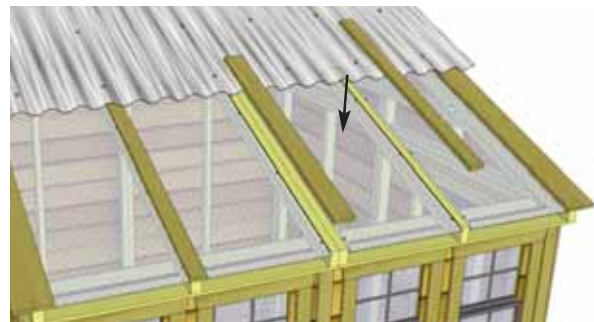

79. Position Mid Ridge Caps evenly spaced on mid rafters. Attach as per **Step 78.**

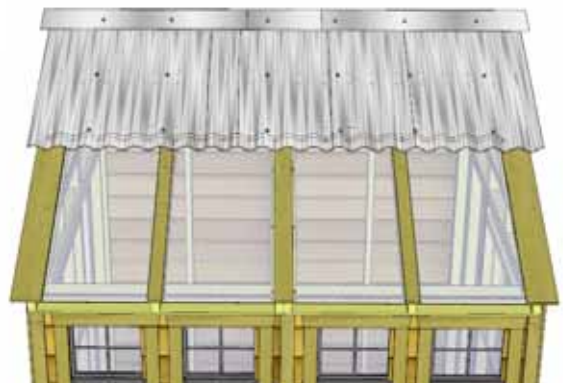
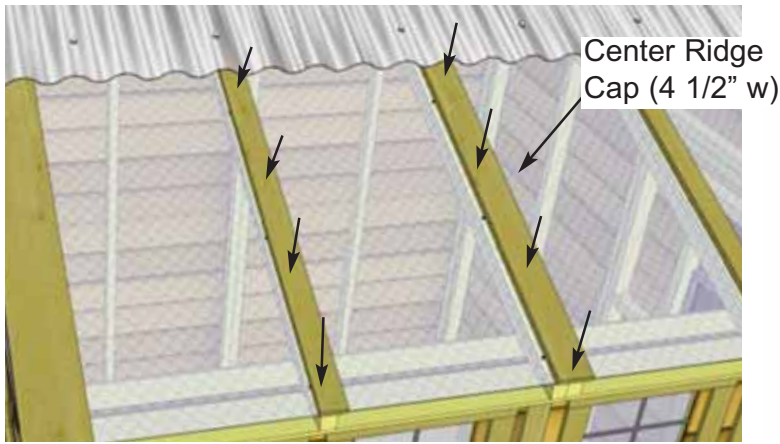

80. Align and attach remaining Ridge Caps as per **Steps 78 & 79.**

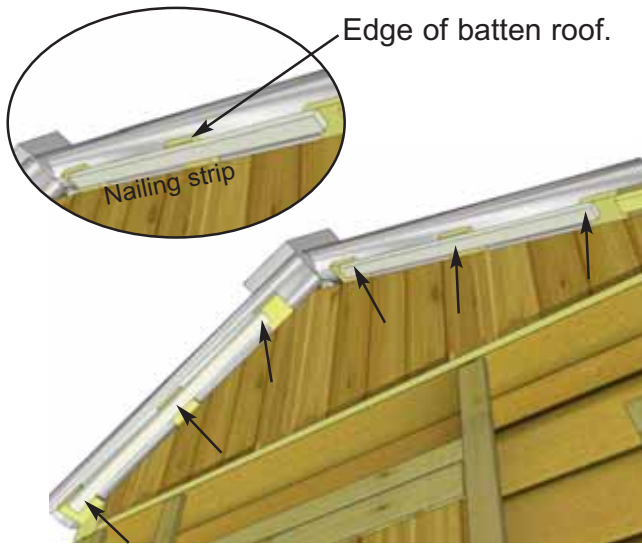

Do a dry run with Front and Rear and Side Facia (**Steps 82-84**) to confirm correct positioning prior to attaching.



81. Attach **Facia Nailing Strips** ($3/4" \times 1\ 1/2" \times 34"$) to the outside of roof battens using 3- $1\ 1/4"$ screws per piece. Do all outside roof panels. Starting with the **Short Roof** side, attach **Front and Rear Facia** ($3/4" \times 3\ 1/2" \times 38\ 3/4"$ angle cut on ends) to end of battens with 5 - $1\ 1/2"$ finishing nails per side. Facia end lines up with rafter ends. Do a dry run with side facia in **Step 82** before attaching.

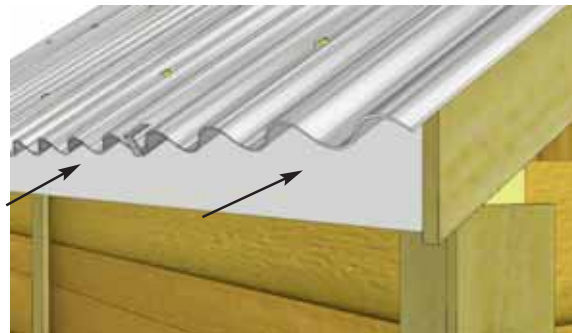

82. Attach **Side Facia** (4 @ $3/4" \times 3\ 1/2" \times 47\ 7/8"$) to roof rafter ends. There are 2 Side Facia pieces per side. Secure with 8 - $1\ 1/2"$ finishing nails per piece. Front and Rear Facia will overlap Side Facia.

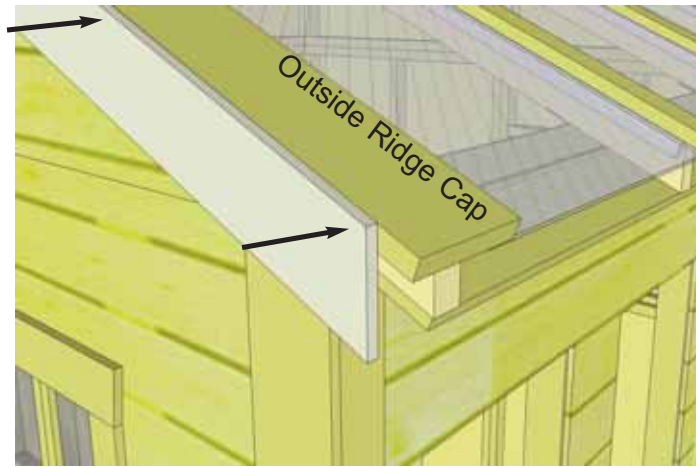

83. Attach Long **Front and Rear Facia** ($3/4" \times 3 1/2" \times 79 1/4"$ angle cut on ends) to batten ends and Outside Ridge Cap edge with both $1 1/2"$ finishing nails and $1 1/4"$ screws. Use 2 screws where Outside Ridge Cap and Facia meet. Line Facia up so it is even with rafter ends.

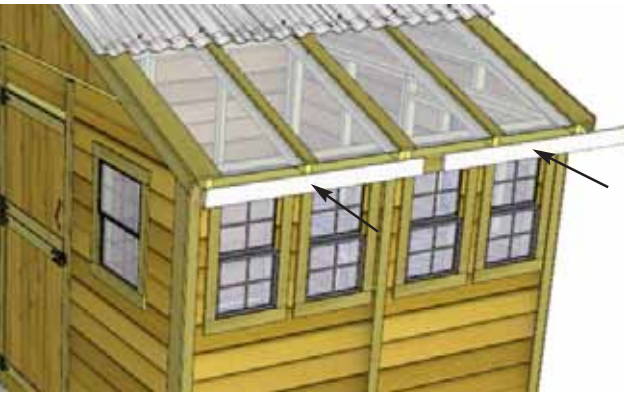

84. Attach remaining **Side Facia** to roof rafter ends as per **Step 82**.

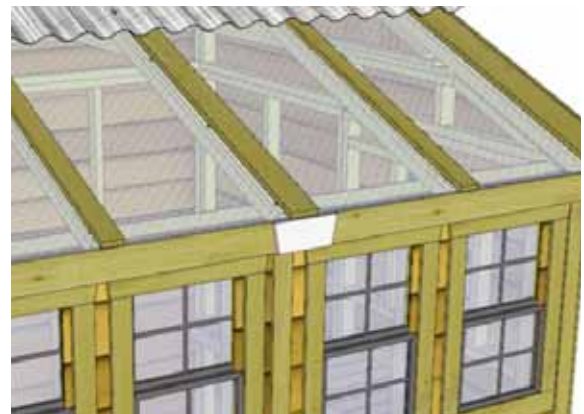

85. Attach **Facia/Trim Detail Plates** and **Pentagon Detail Plates** to cover seams where facia trim pieces come together. Secure each with 4 - $1 1/2"$ finishing nails.



86a. To reduce possible water from penetrating into the window cavity, caulk gap on both sides of window opening prior to installing **Window Insert**. Position insert in cavity and screw with **8 - 1 1/4" Screws**.



86b. Once Insert is attached, caulk the "channel gap" between the Insert's outside flange and the siding. Also put a bead of caulking horizontally at top of window where the flange and siding meet. This additional caulking will also reduce the chances of moisture entering into your shed.

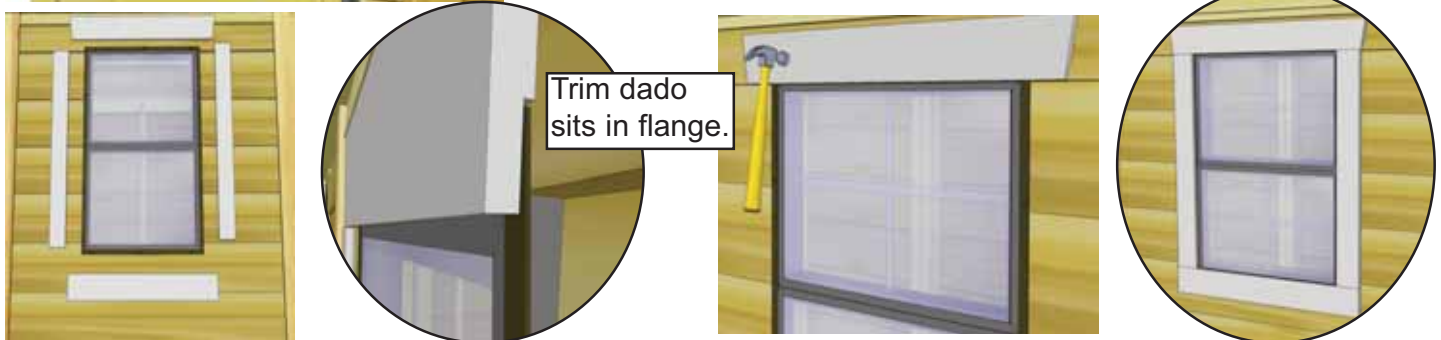
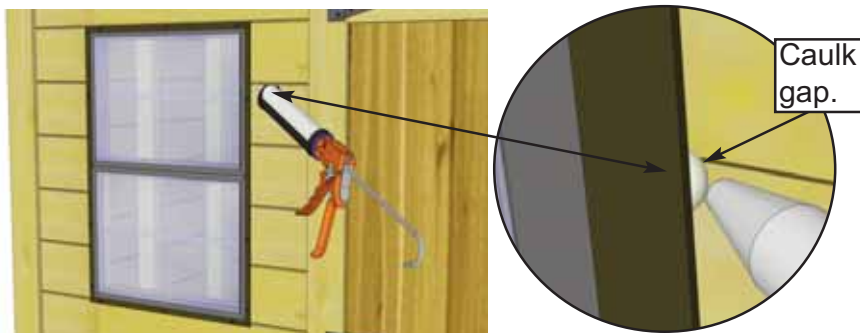

87. Position **Window Trim** around window doing a dry run first and attach with **4 - 1 1/2" Finishing Nails** per piece. Window trim has a small dado on reverse face. Outside flange of window will roughly sit in the dado to give a better fit.



88. To complete trimming of your shed, attach both the **Horizontal Door Trim** (32") and **Horizontal Narrow Wall Trim** (8 3/4") with 4 and 2 - 1 1/2" finishing nails.



89. Attach **Horizontal Gable Trim** (1/2" x 4 1/2" x 85 1/2") to both front and rear of shed. Position equally over gable and wall seam to cover Gable Flashing. Use 8 - 1 1/2" finishing nails per piece to secure.

90. Assemble **Flower Box Kit** with Assembly Instructions included. Position completed Flower Box below bottom of window trim and secure with 2 - 2 1/2" screws. Screw from inside of box into the center wall stud. Attach second screw 2" underneath first screw and once again into the wall stud. Install Flower Box Kits underneath each window.

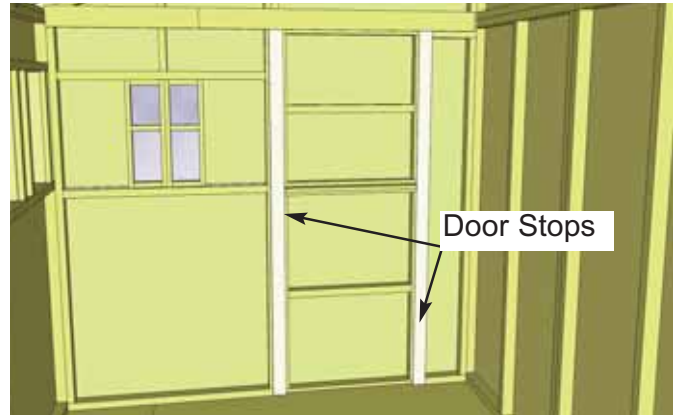
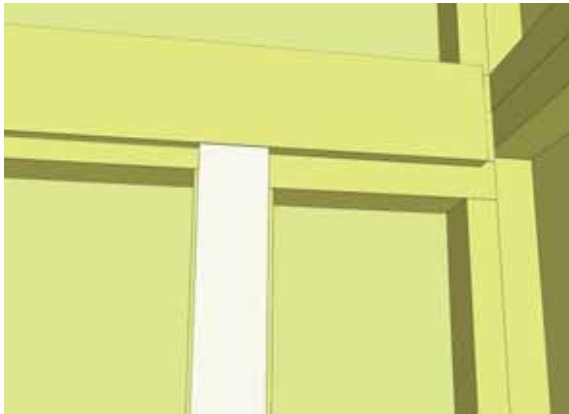

91. Attach Interior **Vertical Door Stops** to door framing from inside of shed. Use 4 - 2" screws to secure each Stop. Stops should overlap door by approx. 1/2".

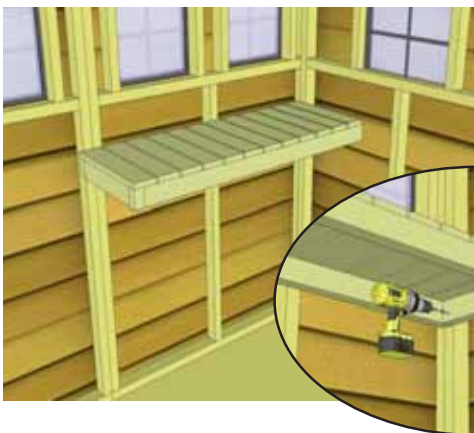

92. Locate 1 Long **Potting Shelf** and 1 **Leg**. Position shelf in corner tight against wall framing. While supporting the shelf, attach shelf with 2 1/2" screw. Place leg underneath shelf and attach to inside shelf frame and wall framing as illustrated above with 2 1/2" screws.



93. Place Short Potting Shelf against wall framing and end of long shelf framing. Attach with 2 1/2 " screws as per **Step 92**. Use a level to confirm shelving is square and level. Attach leg as previously illustrated. Screw to wall stud and up into the underside of the of shelf framing.

Complete attaching remaining long shelf in corner as per **Steps 92 & 93**.

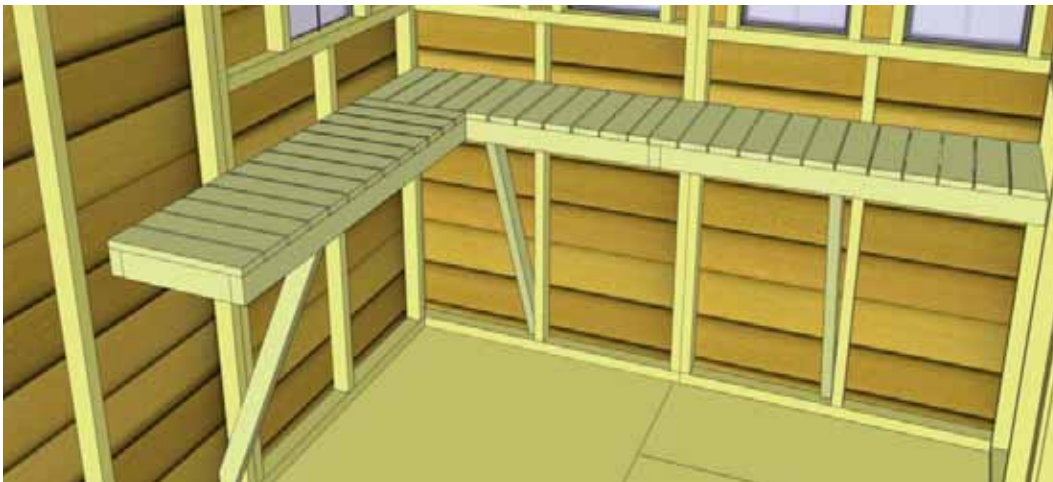

Completed
Potting Shelf

Outdoor Living Today Flower Box Assembly Instructions

Parts Lists:

A - Base, Rear & Front Box Frames	(3pcs)	3/4" x 5 1/2" x 23"
B - End Cap Frames	(2pcs)	3/4" x 5 1/2" x 7" / 8"
C - Front Trim	(1 pc)	3/4" x 1 1/2" x 26"
D - Side Trims	(2 pc)	3/4" x 1 1/2" x 8 3/4"
E - Brackets	(2 pc)	1 1/2" x 5 1/2" x 5 1/2"
F - 1 1/4" Screws		
G - 1 1/4" Nails		

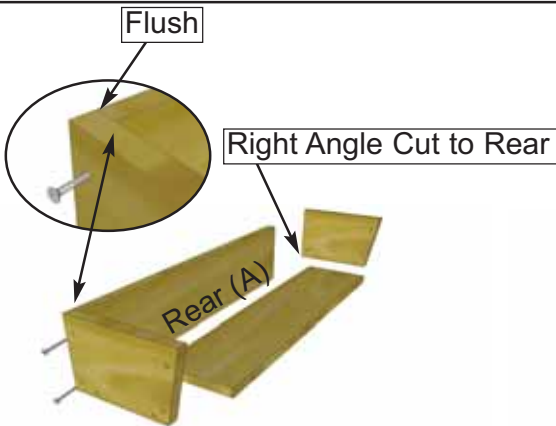
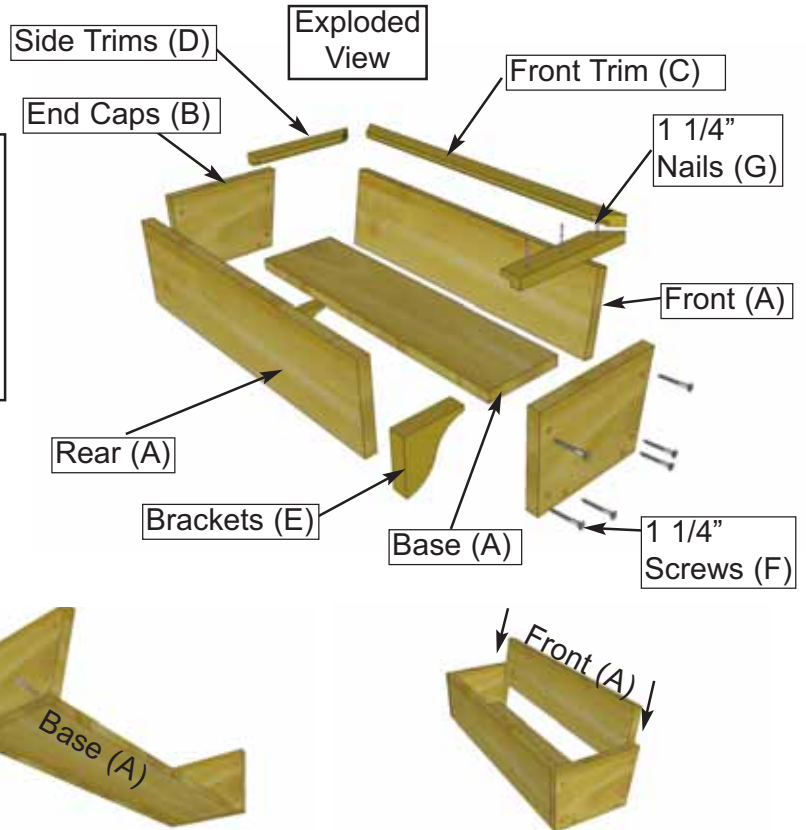

1. On a table position Rear Box and End Cap Frames together so flush at top. Fasten together with 2 - 1 1/4" screws. Place Base Frame tight against Rear and End Cap and flush at bottom. Secure with 2 - 1 1/4" screws. Complete attachment of remaining End Cap Frame. Slide Front Frame between End Caps.

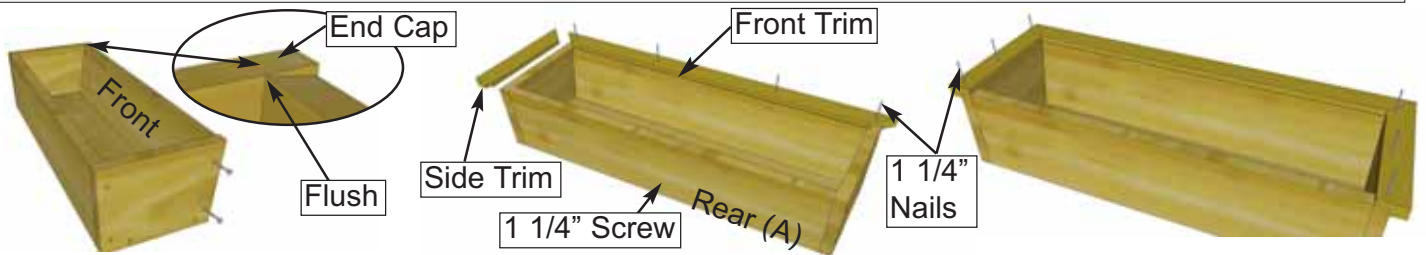

2. Position Front Frame Piece flush with End Cap. Attach both ends with 2 - 1 1/4" screws. Pilot hole Rear Box Frame near bottom center and secure to Base edge with 1 - 1 1/4" screw. Evenly position Front Trim (mitre cut on end and dado cut on inside bottom) tight against front frame and nail down with 4 - 1 1/4" nails. Position Side Trims as per Front and secure with 3 - 1 1/4" nails per side.

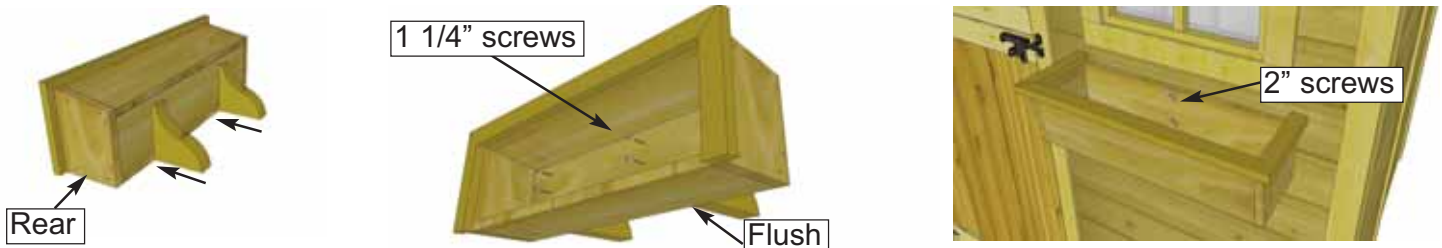

3. On a flat surface, flip Flower Box on it's rear face. Evenly space Brackets and secure through Base Frame and into the Brackets with 2 - 1 1/4" screws per Bracket. Position completed Flower Box beneath window trim and screw from inside of box into the center wall stud with 2 - 2" screws. (2" screws supplied with Base Kit.)



Congratulations on Completing your 8 x 8 Sunshed (Metal Roof)!

We hope your experience constructing your Garden Shed has been both positive and rewarding.

Note: Our Sheds are shipped as an unfinished product. If exposed to the elements, the western red cedar lumber will weather to a silvery-gray color. If you prefer to keep the cedar lumber looking closer to the original color, we suggest that you treat the wood with a good oil base wood stain. You may also wish to paint your new shed rather than stain it. In both cases we recommend that you consult with a paint and stain dealer in your area for their recommendations.



We value your feedback and would like to hear back from you on how well we are doing in the following areas:

1. **Customer Service**
2. **On Time Shipping**
3. **Motor Freight Delivery**
4. **Quality of Materials**
5. **Assembly Manual**
6. **Overall Satisfaction.**

Please call, write or email us at:

Outdoor Living Today

Canadian Address
9393 287th Street
Maple Ridge, British Columbia
Canada V2W 1L1

United States Address
P.O. Box 96
Sumas, Washington
USA 98295



The materials contained in this Assembly Manual may be downloaded or copied provided that **ALL** copies retain the copyright and any other proprietary notices contained on the materials. No material may be modified, edited or taken out of context such that its use creates a false or misleading statement or impression as to the positions, statements or actions.