

SOJAG

produits saisonniers • seasonal products

QUESTIONS? 1-866-901-1649

Assembly Manual / Guide d'assemblage / Manual de ensamblaje / 조립설명서 / Montageanleitung

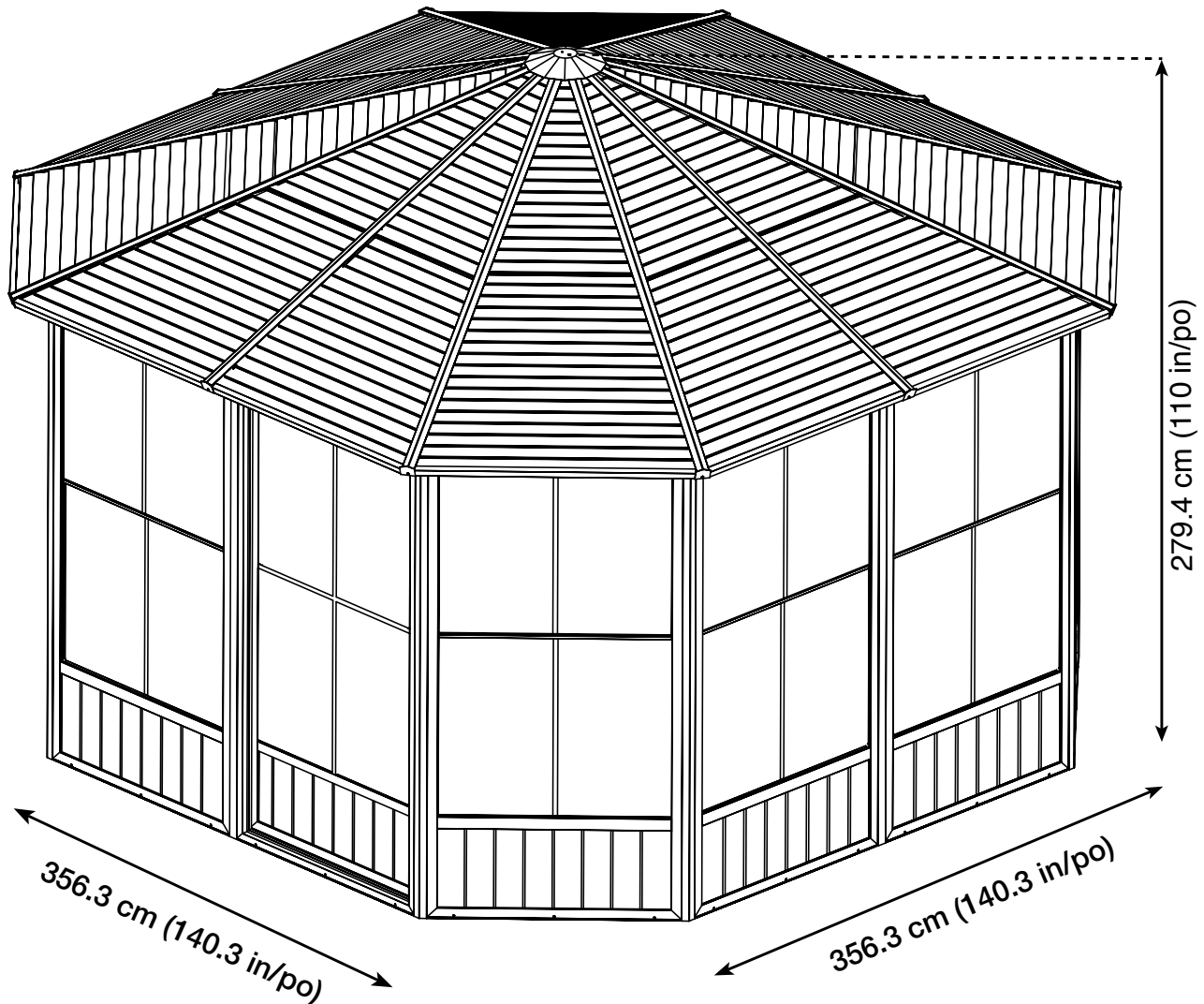

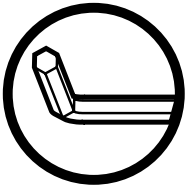

Use the hex keys in the box. / Utilisez les clés hexagonales fournies dans la boîte. /
Utilice las llaves hexagonales en la caja. / 상자에 육각 키를 사용 하십시오. / Verwenden Sie
die Sechskantschlüssel in der Box.

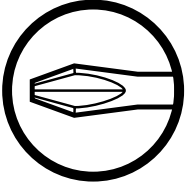

Please use a Phillips screwdriver. / Utilisez un tournevis de type Phillips / Por favor,
use un destornillador Phillips. / 십자 드라이버를 사용 하십시오. / Bitte verwenden
Sie einen Kreuzschraubenzieher.

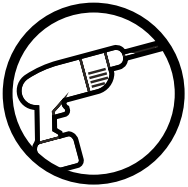

You may need to use a drill for this step. / Vous pouvez avoir besoin d'utiliser une
perceuse pour cette étape. / Puede que tenga que utilizar un taladro para este paso. /
이 단계에선 드릴을 사용해야 할 수도 있습니다. / Für diesen Schritt können Sie einen
Bohrer verwenden.



Wearing protective gloves is recommended. / Le port de gants de protection est recommandé /
El uso de guantes de protección se recomienda. / 보호 장갑을 착용 하는 것이 좋습니다. /
Das Tragen von Schutzhandschuhen wird empfohlen.



Two or more people are required at this stage. / Deux personnes ou plus sont nécessaires à cette
étape. / Dos o más personas se requieren en esta etapa. / 이 단계에서는 두 명 이상 이 필요합니다. /
Für diesen Bauschritt sind 2 oder mehr Personen erforderlich.



Do not tighten screws all the way for now. / Ne pas visser fermement pour l'instant. /
No atornille con firmeza por ahora. / 아직 나사를 단단히 조이지 마십시오. / Bitte die
Schrauben zum jetzigen Zeitpunkt noch nicht fest anziehen.



Sold separately. / Vendus séparément. / vendido en las opciones. /
옵션 판매 / Optional erhältlich

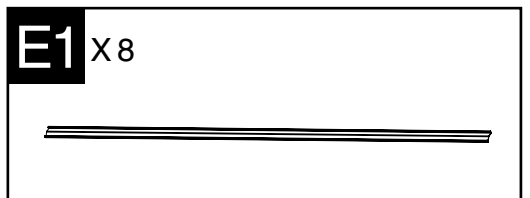
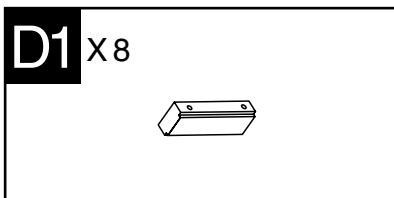
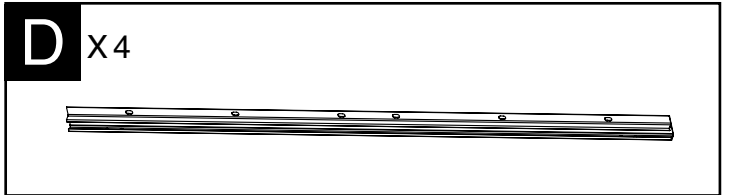
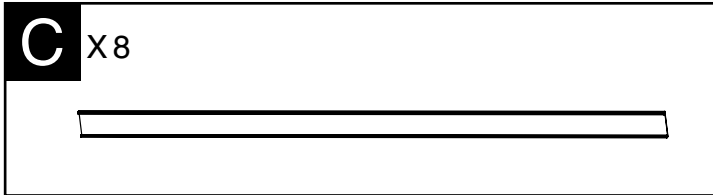
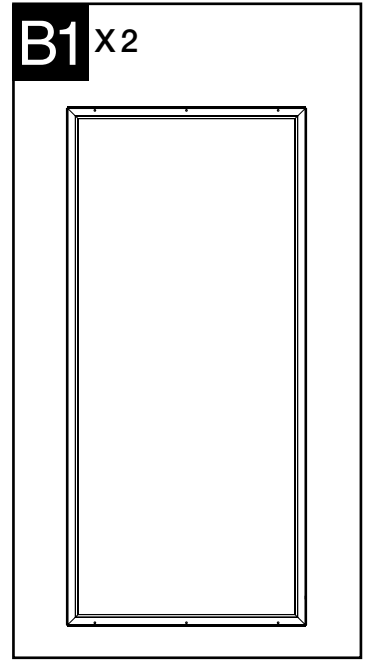
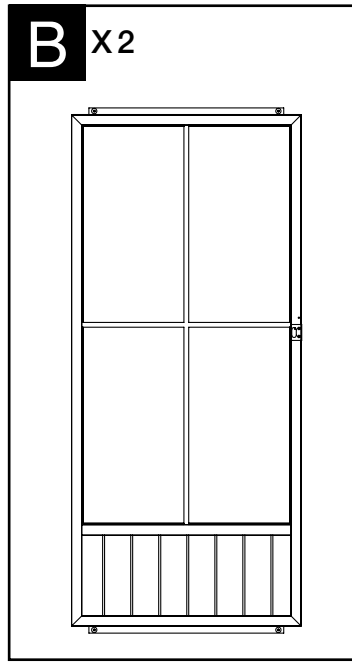
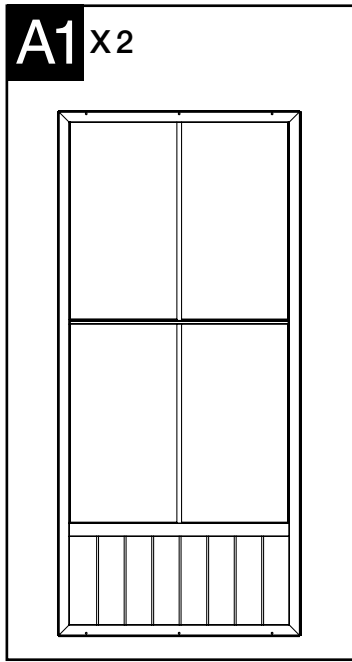
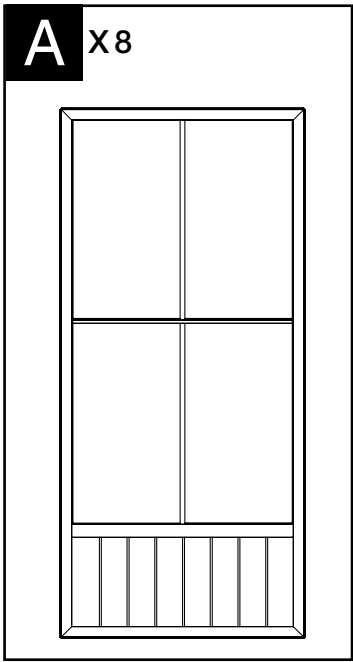
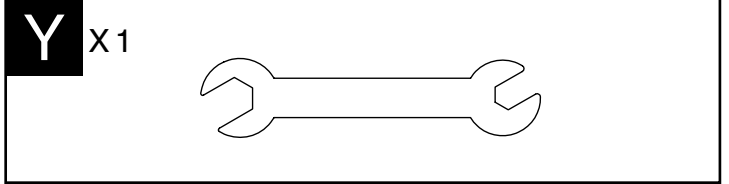
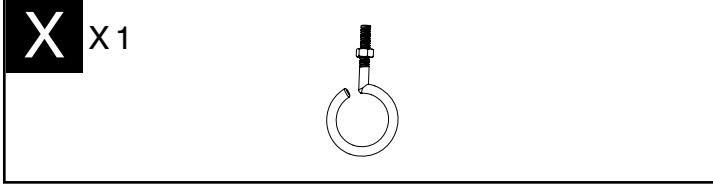
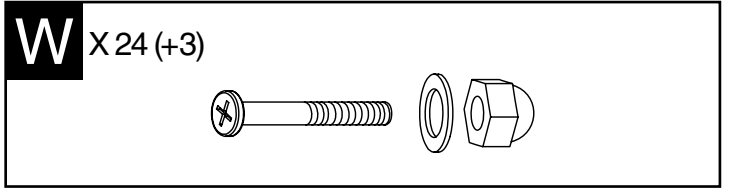
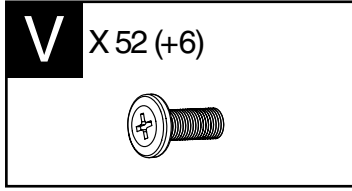
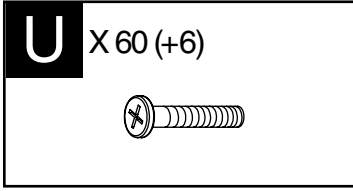
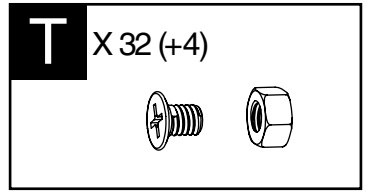
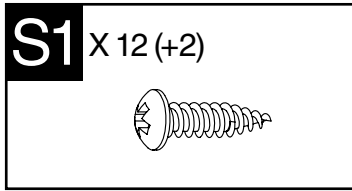
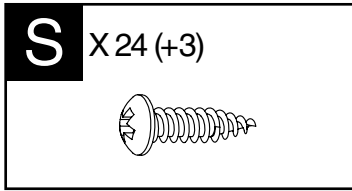
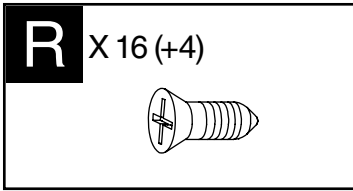

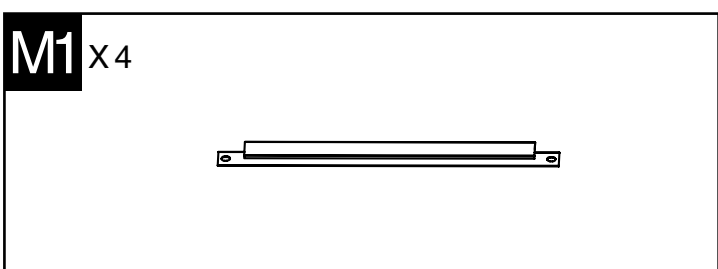
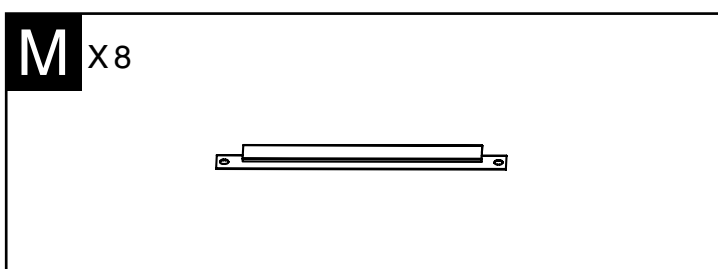
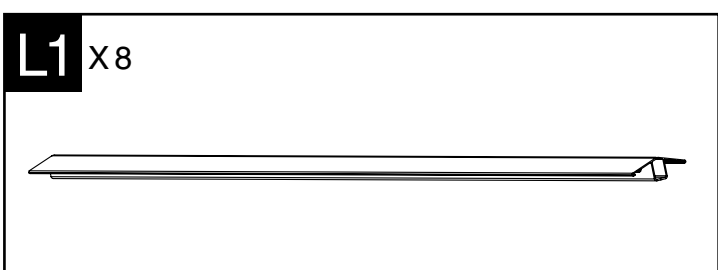
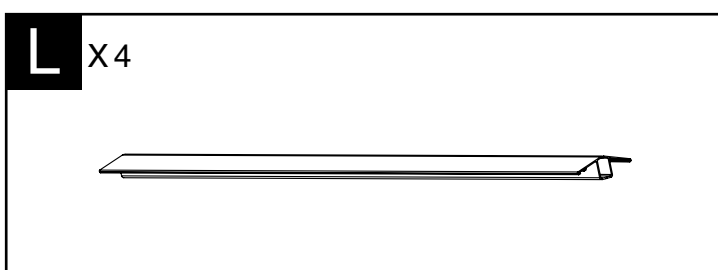
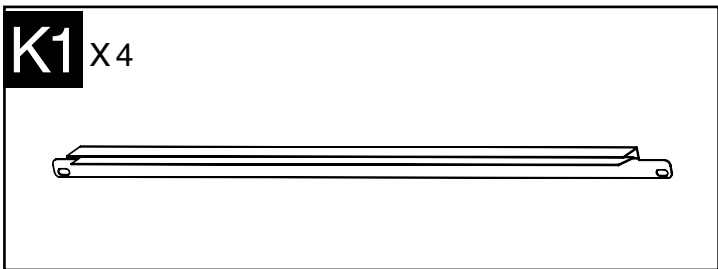
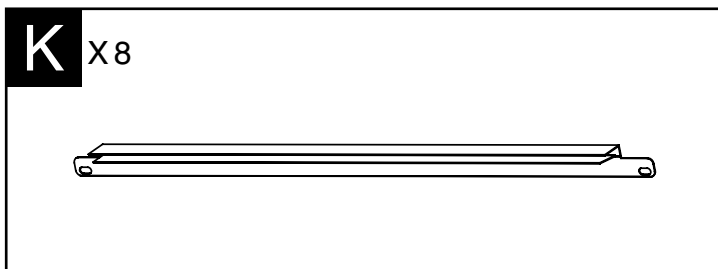
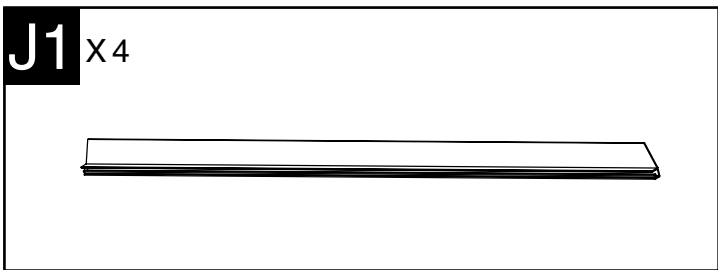
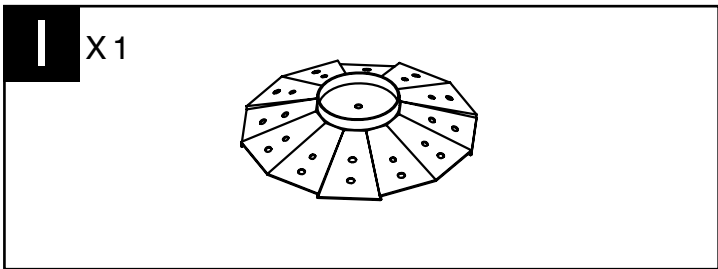
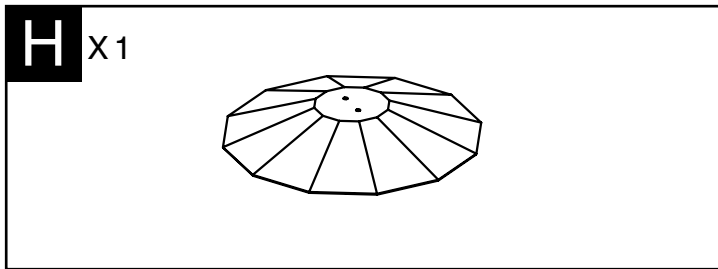
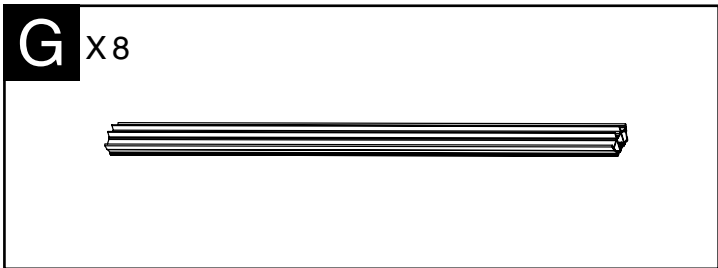
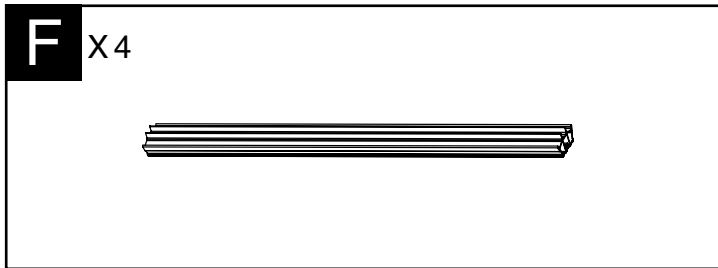

B3 X8

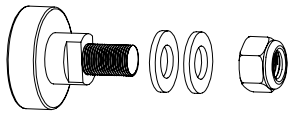

N X4

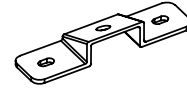

O X8

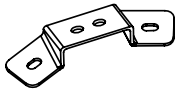

P X12

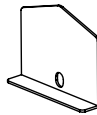

Q X2

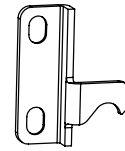

Winter Bar / Barre hivernale Ajustable

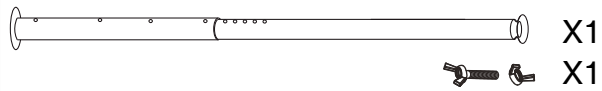

X1

X1



Qa X4

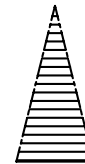

Qb X4

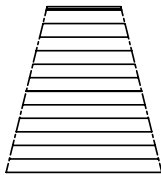

Qc X4

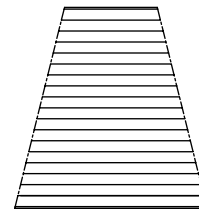

Ra X4

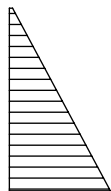

Rb X4

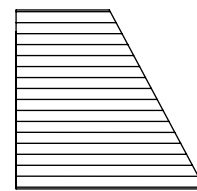

R1a X4

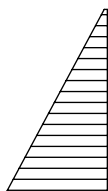

R1b X4

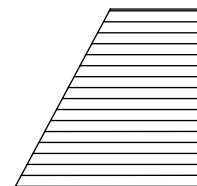

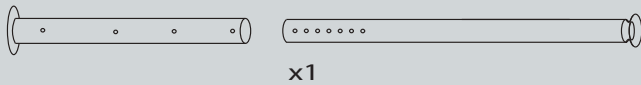
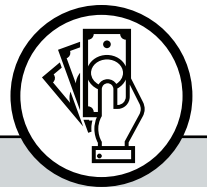
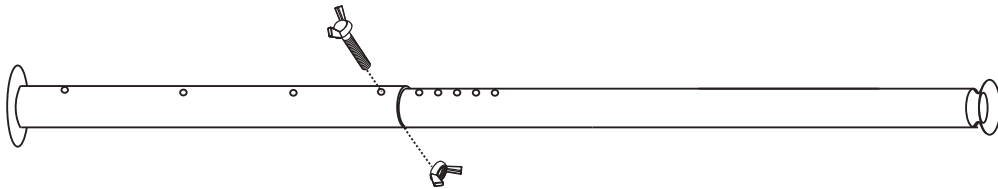
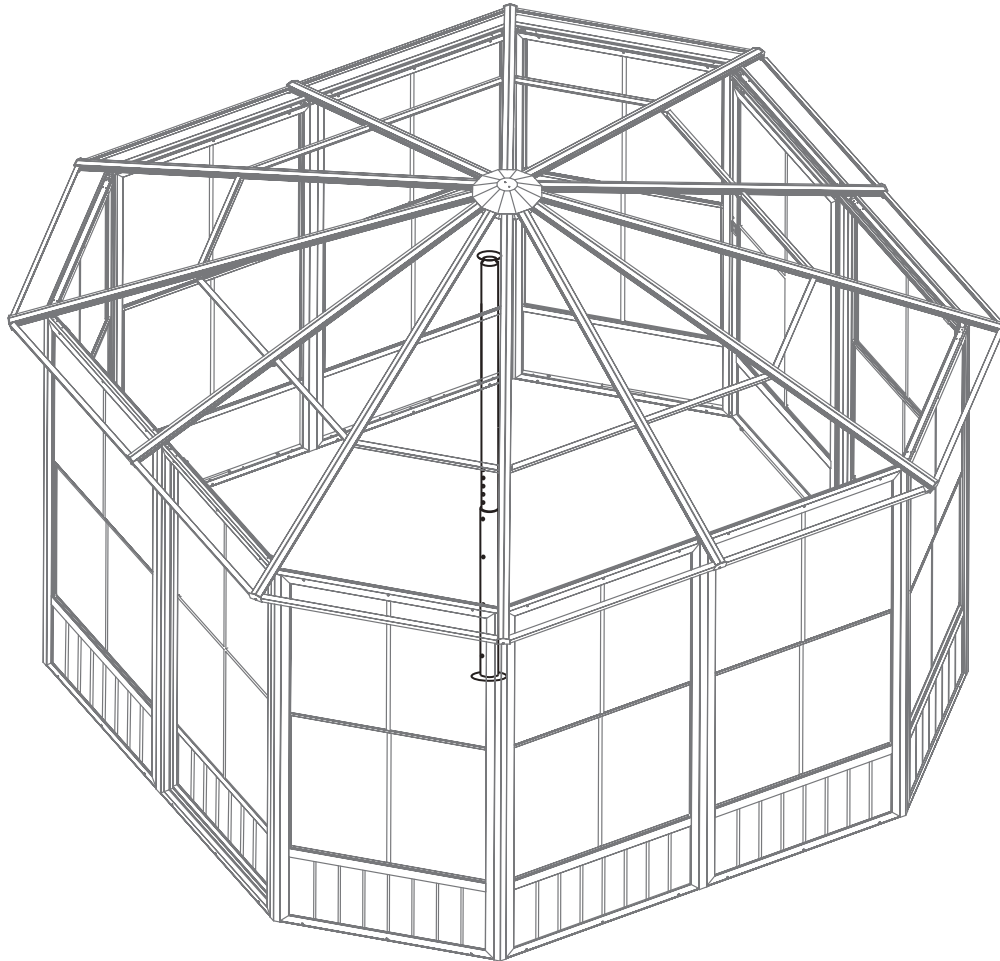
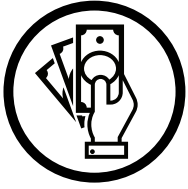

x1

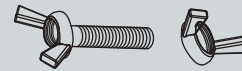

x1

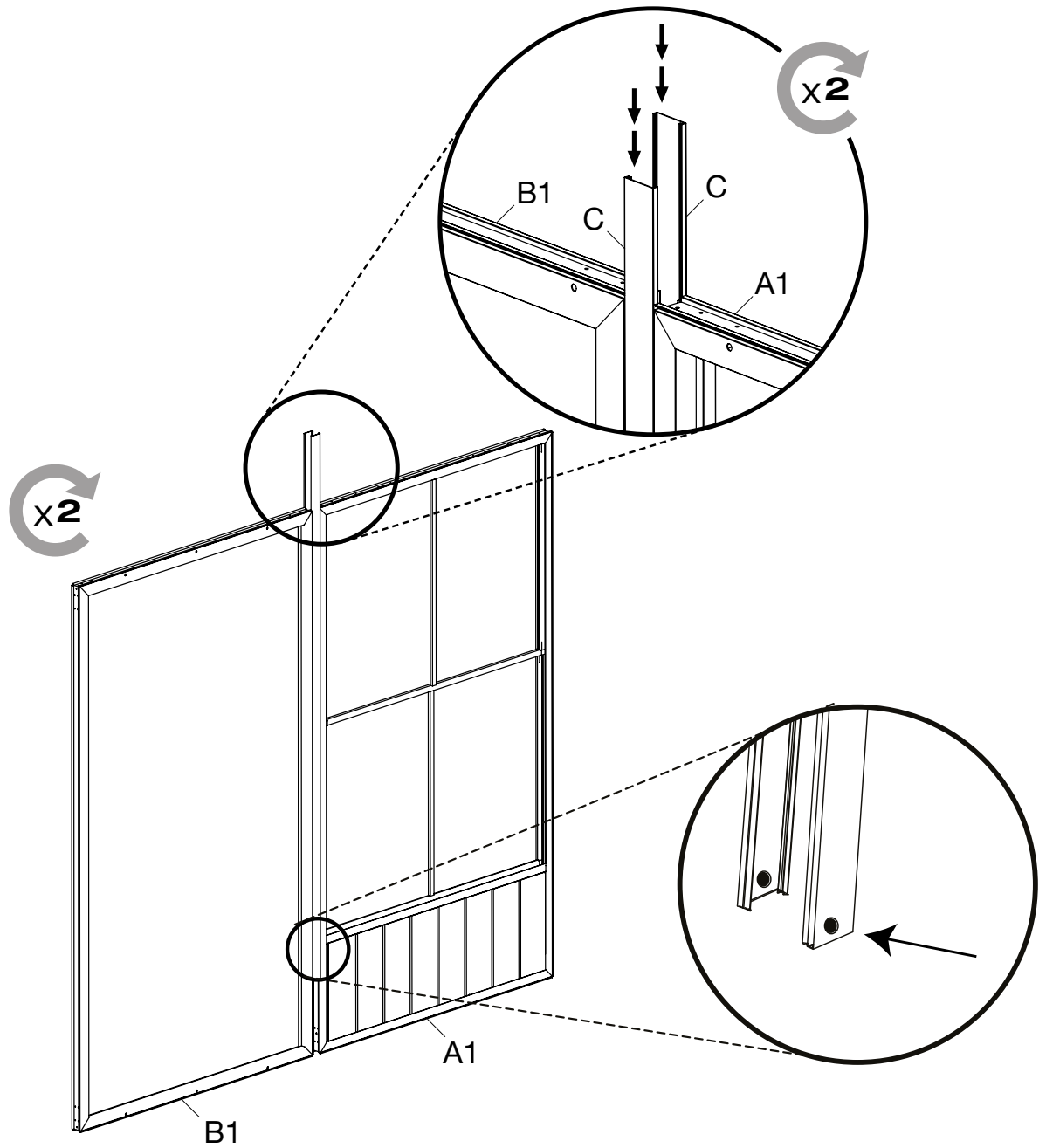

This section contains the parts list and a safety icon. On the left, there are two icons: a window frame labeled A1x2 and a vertical frame part labeled B1x2. In the center, there is a long, thin horizontal bar labeled Cx4. On the right, there is a circular icon containing two stylized human figures and the text '2+', indicating that two people are required for installation.

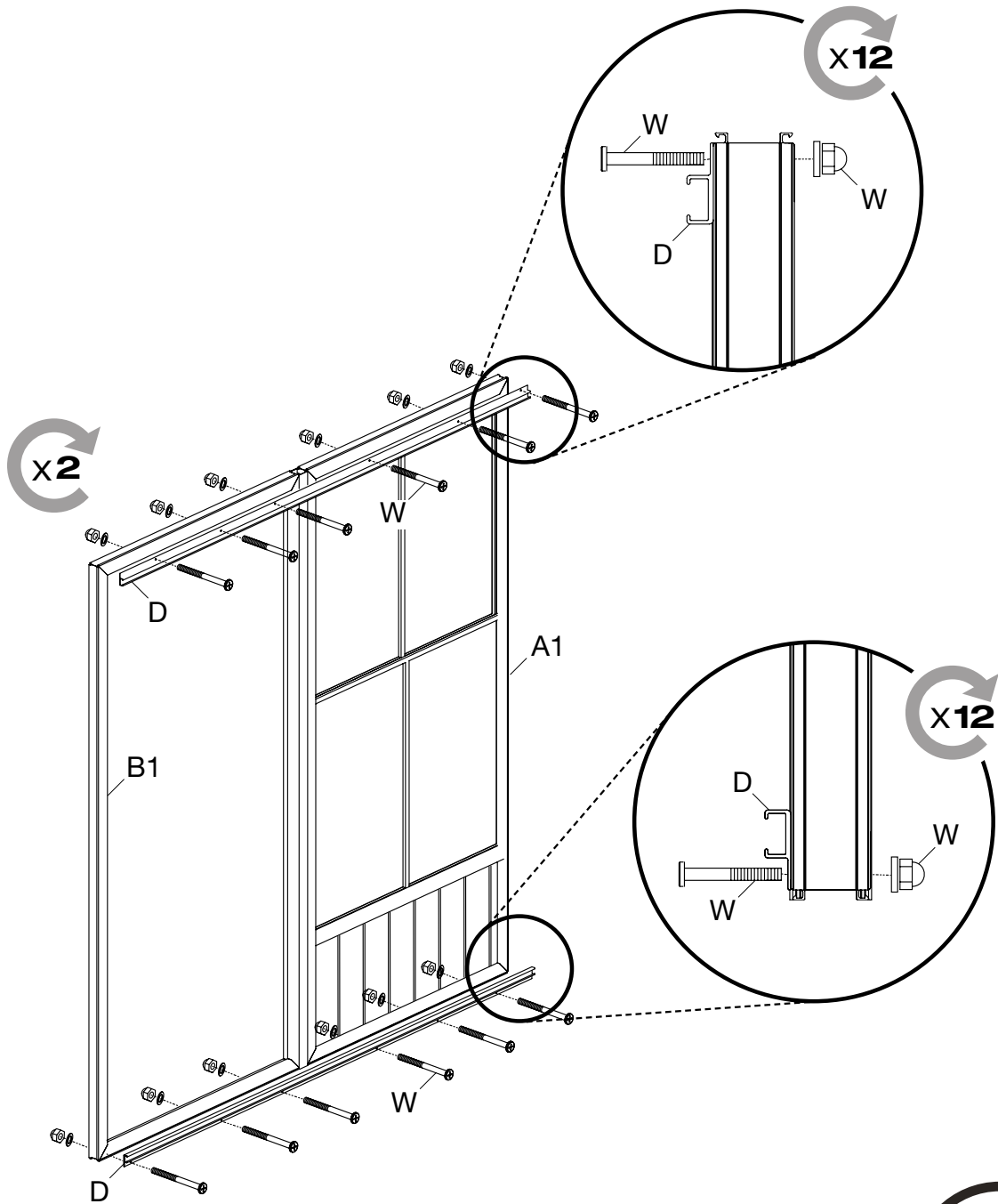

This section contains a parts list and an icon. On the left, there is a screw labeled **Wx24**, a washer, and a nut. In the center, there is a long, thin metal bar labeled **Dx4**. On the right, there is a circular icon containing two stylized human figures and the text **2+**, indicating that two or more people are required for assembly.

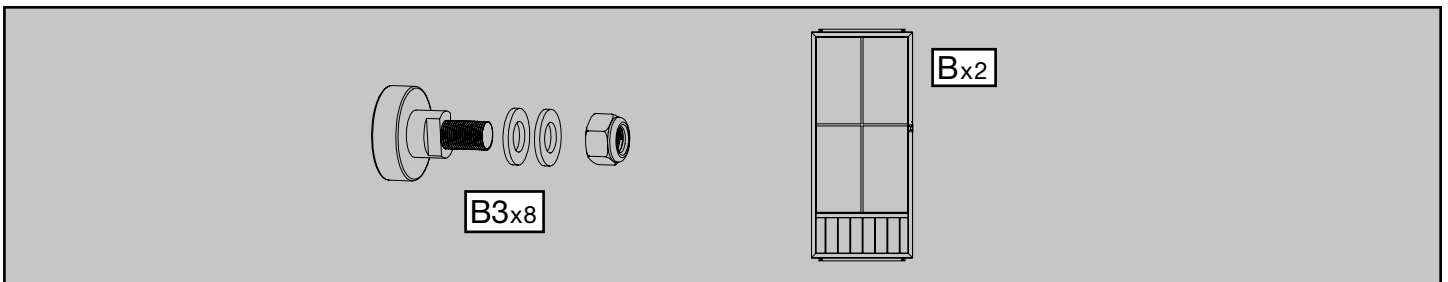
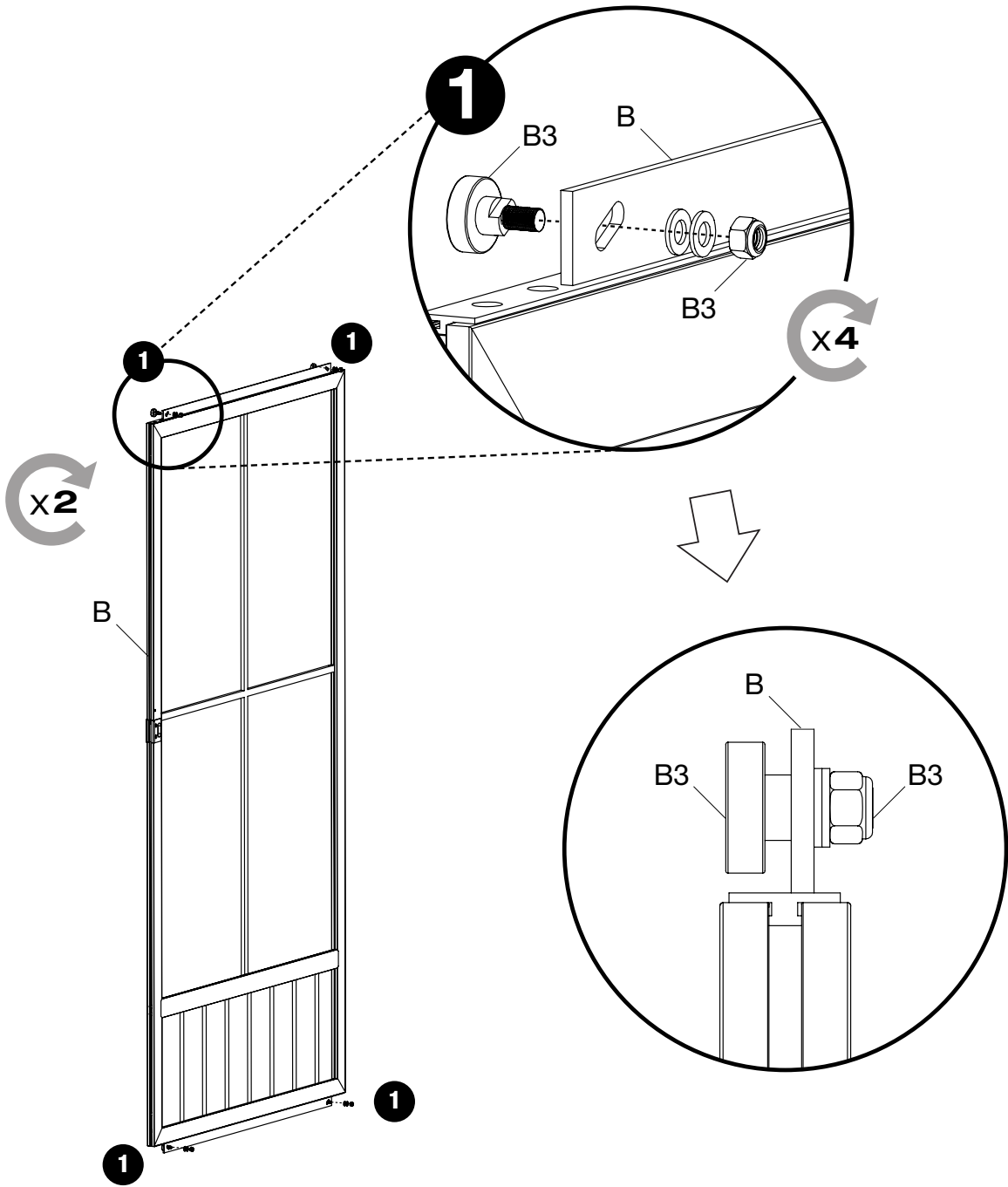

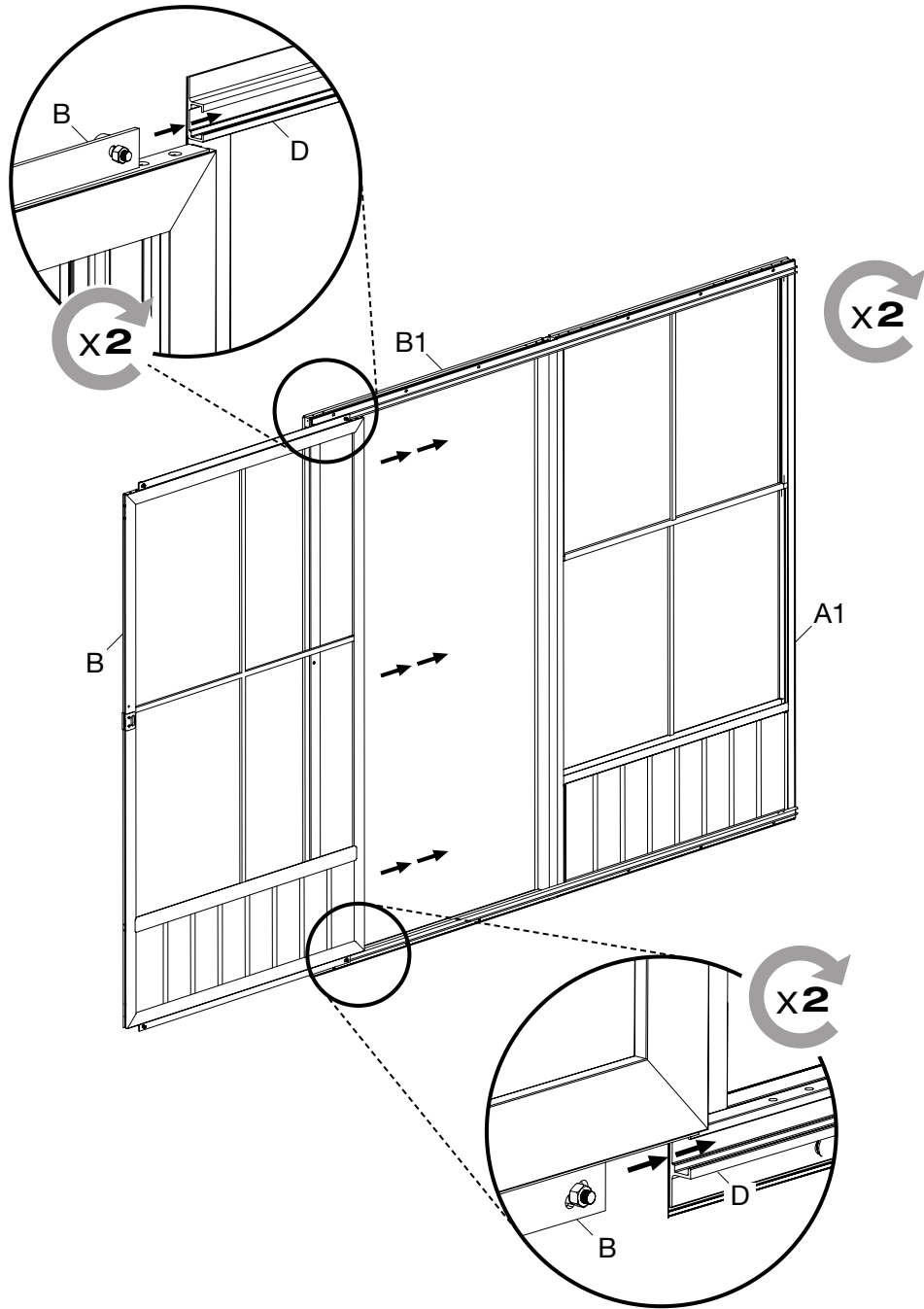

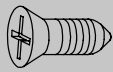
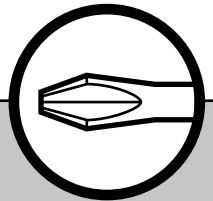
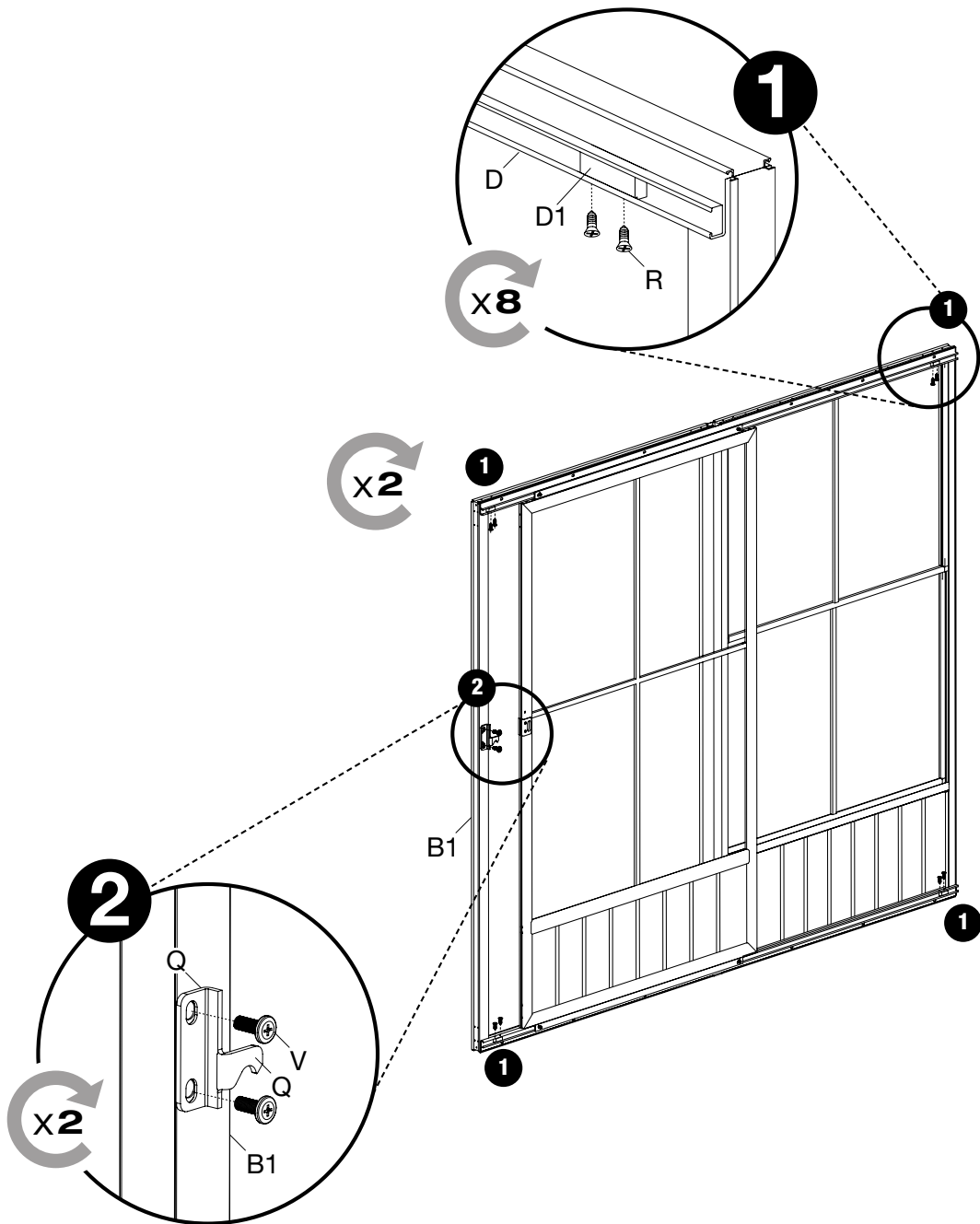

Rx16

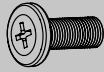

Vx4

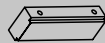

D1x8

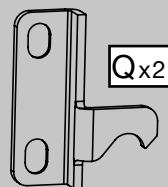

Qx2

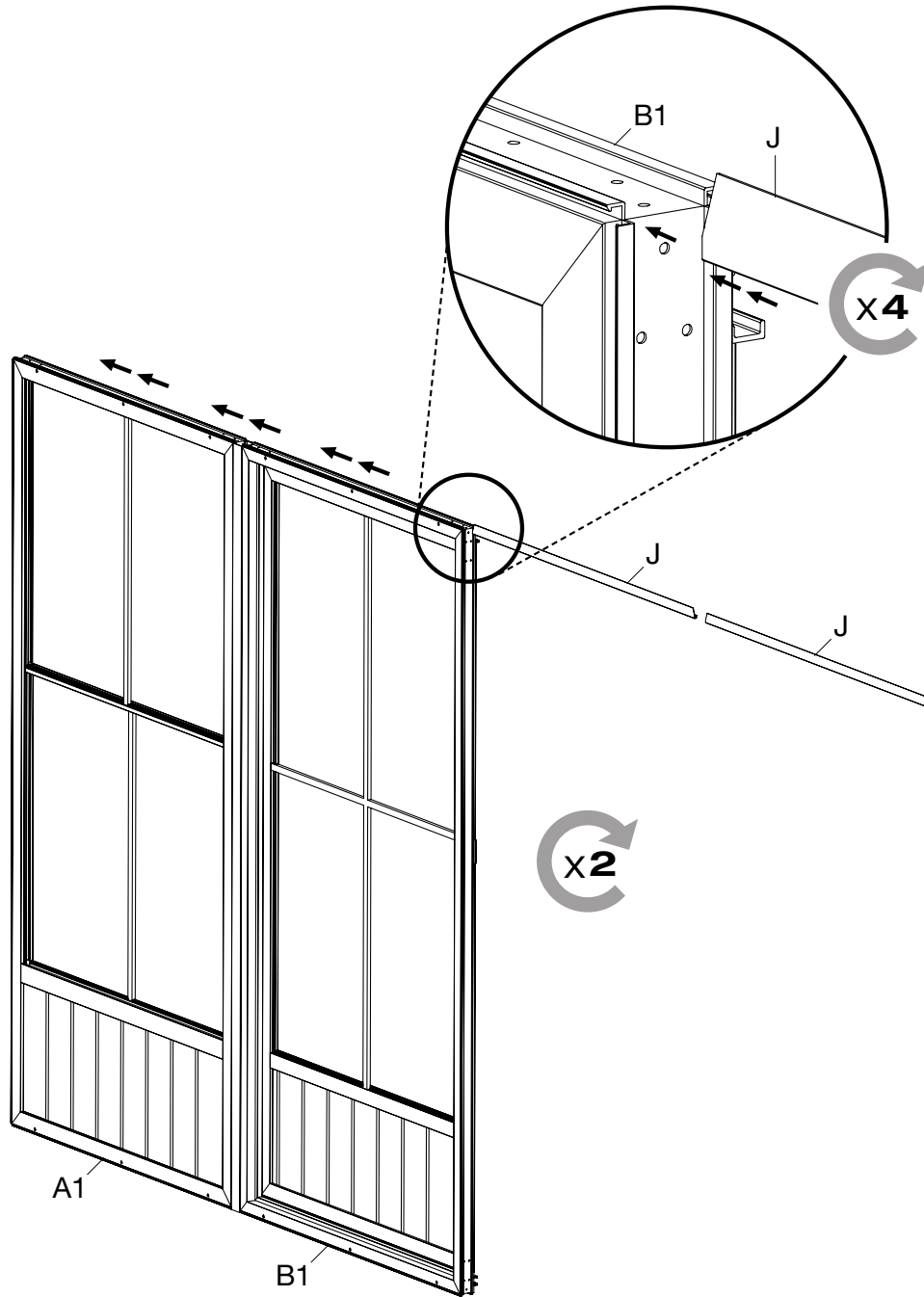

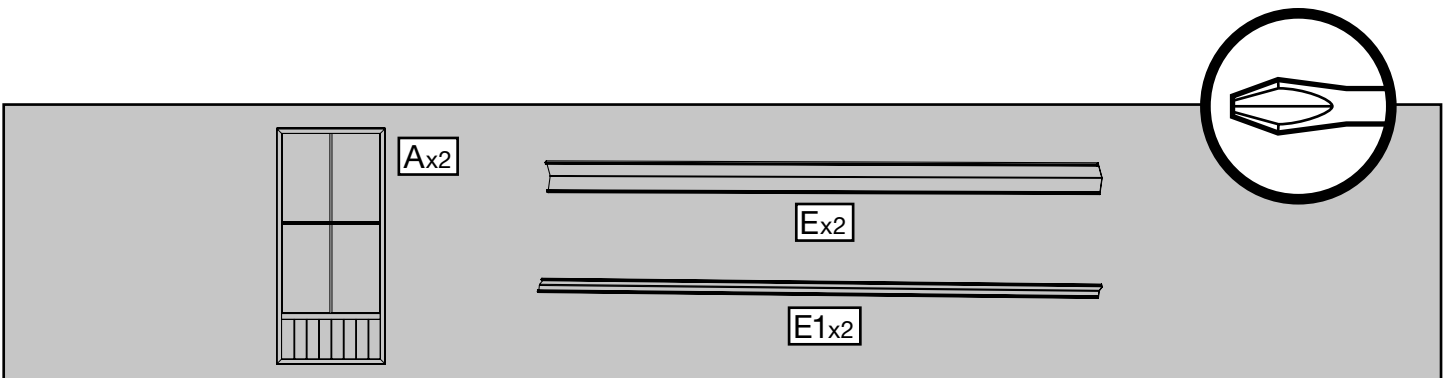
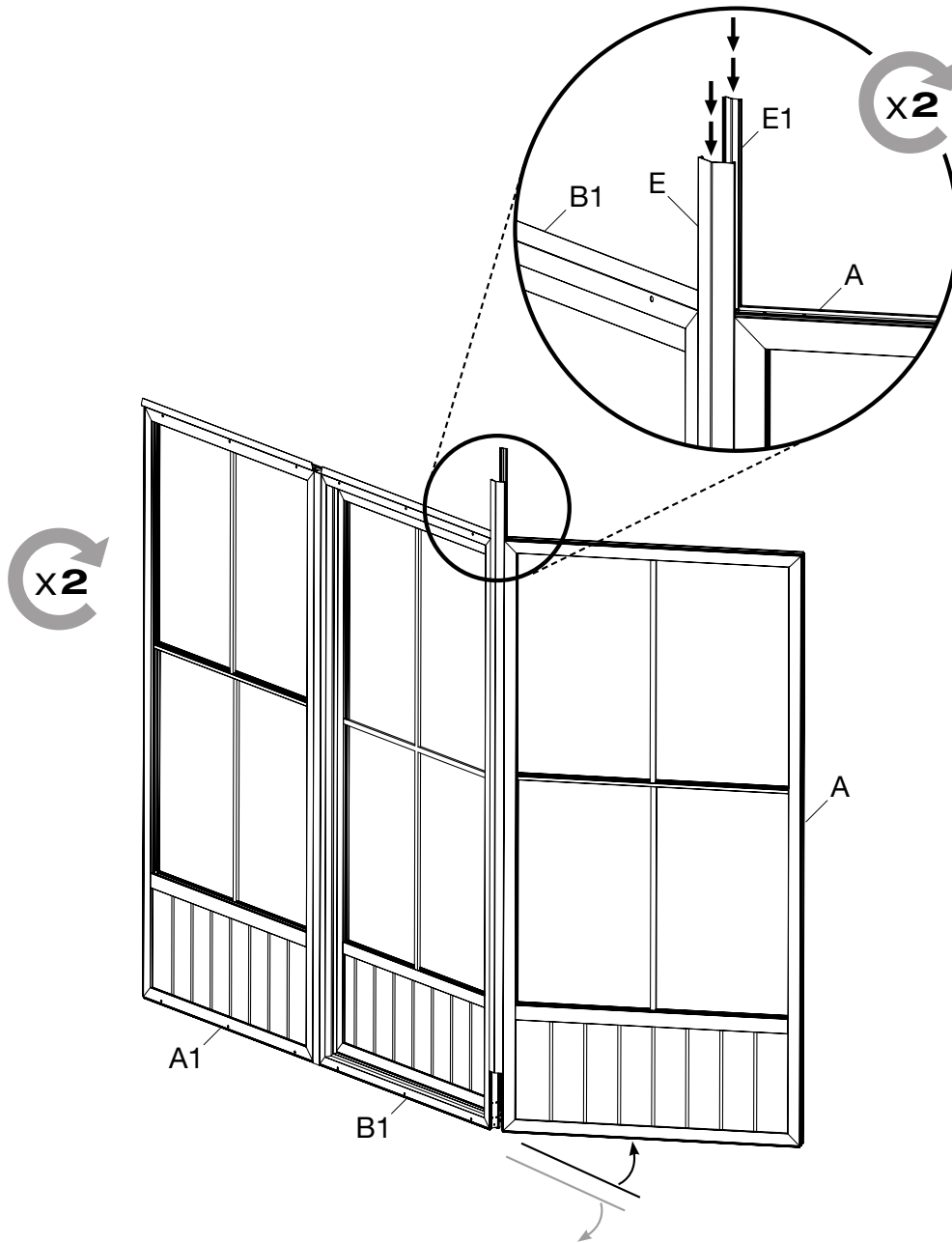

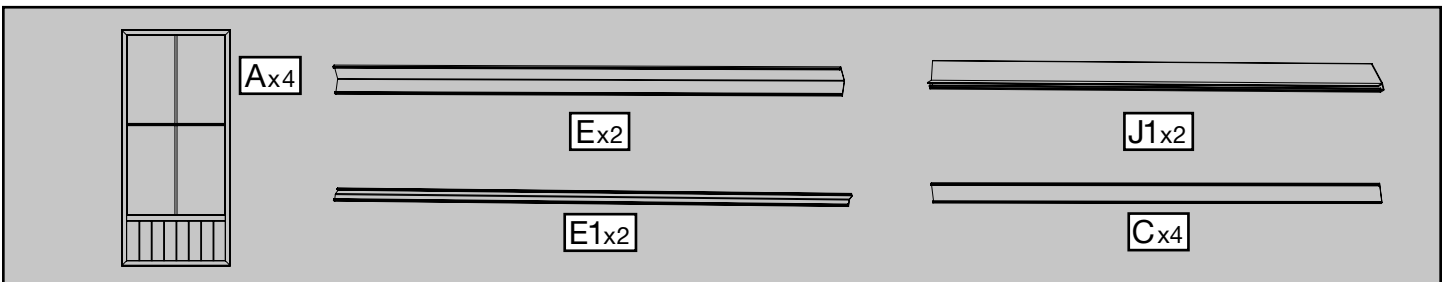
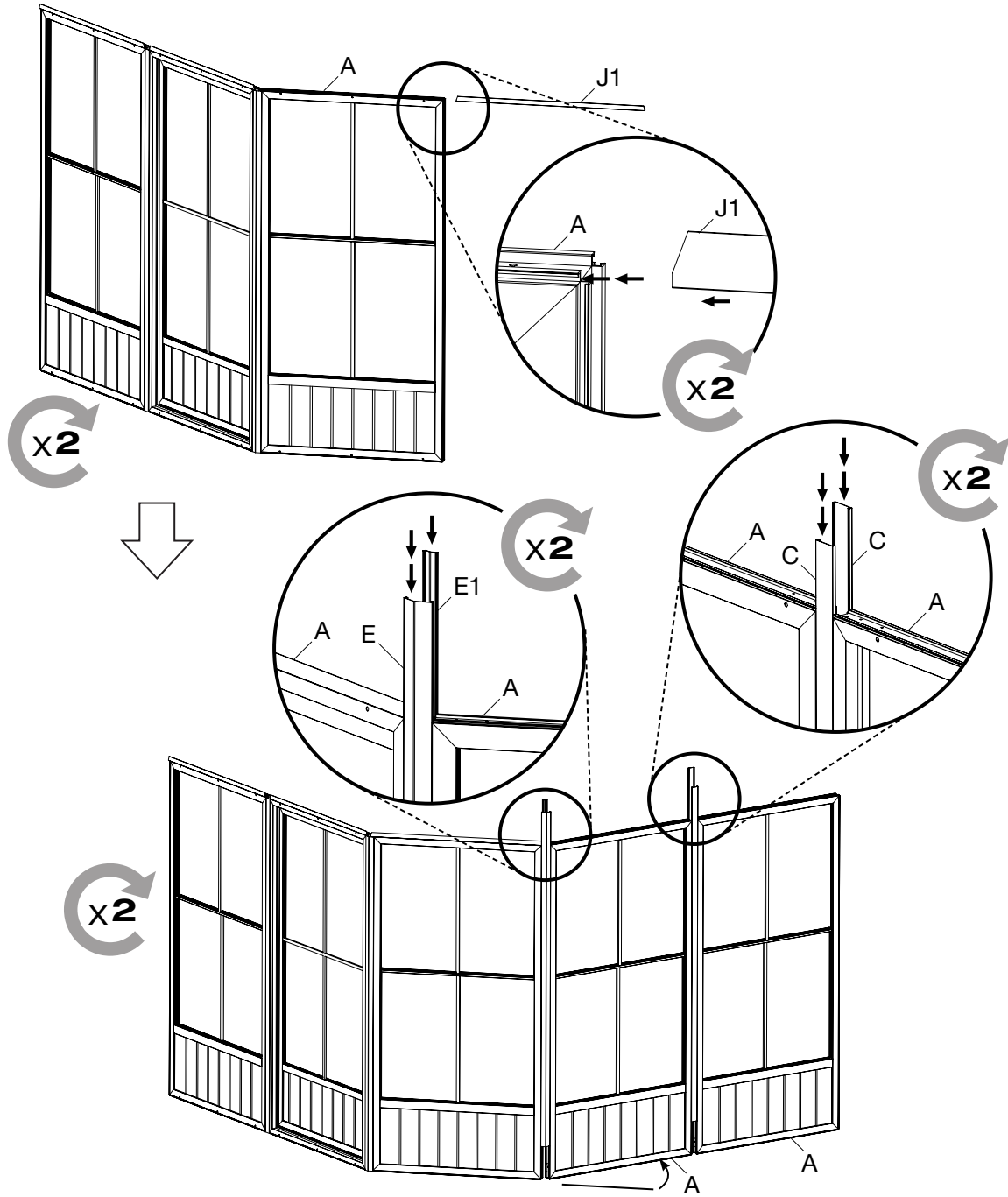

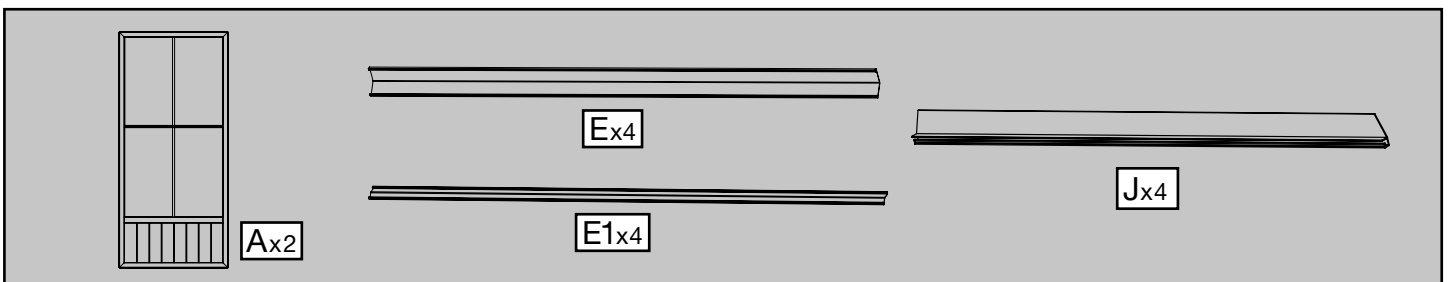
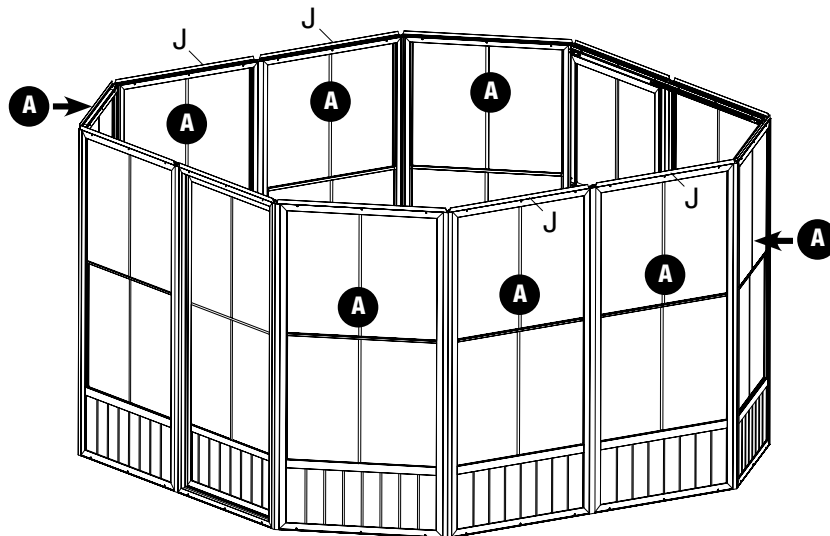
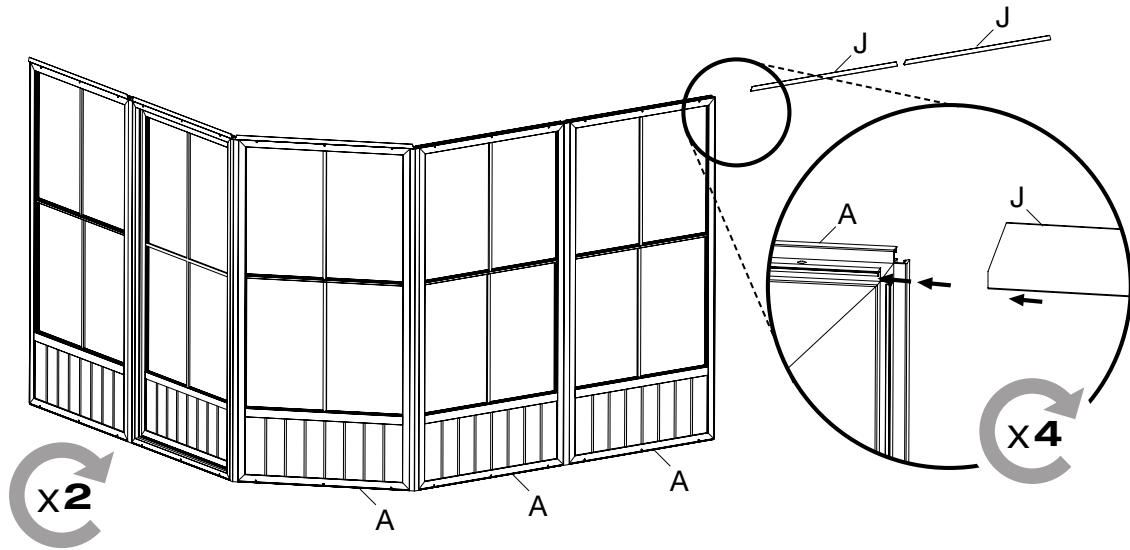

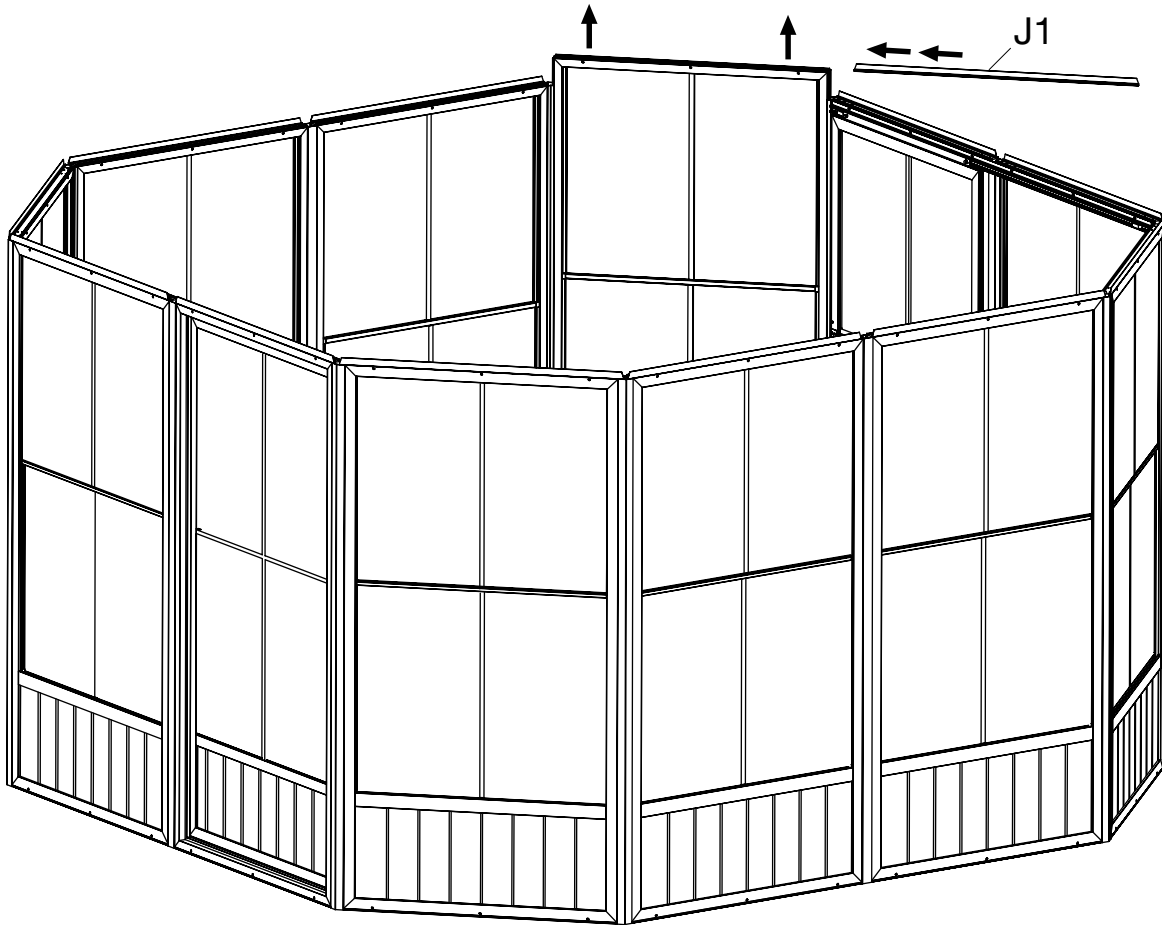

J1x2

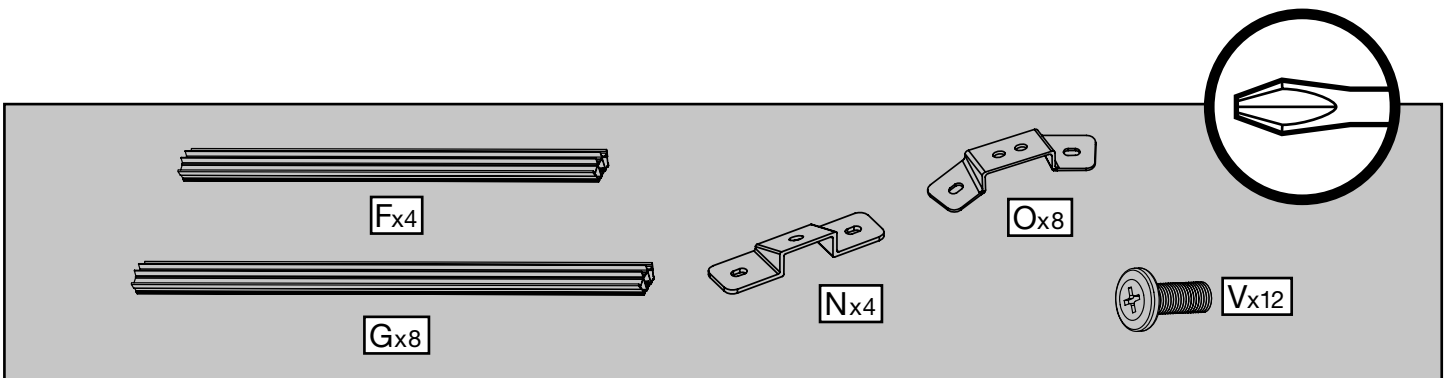
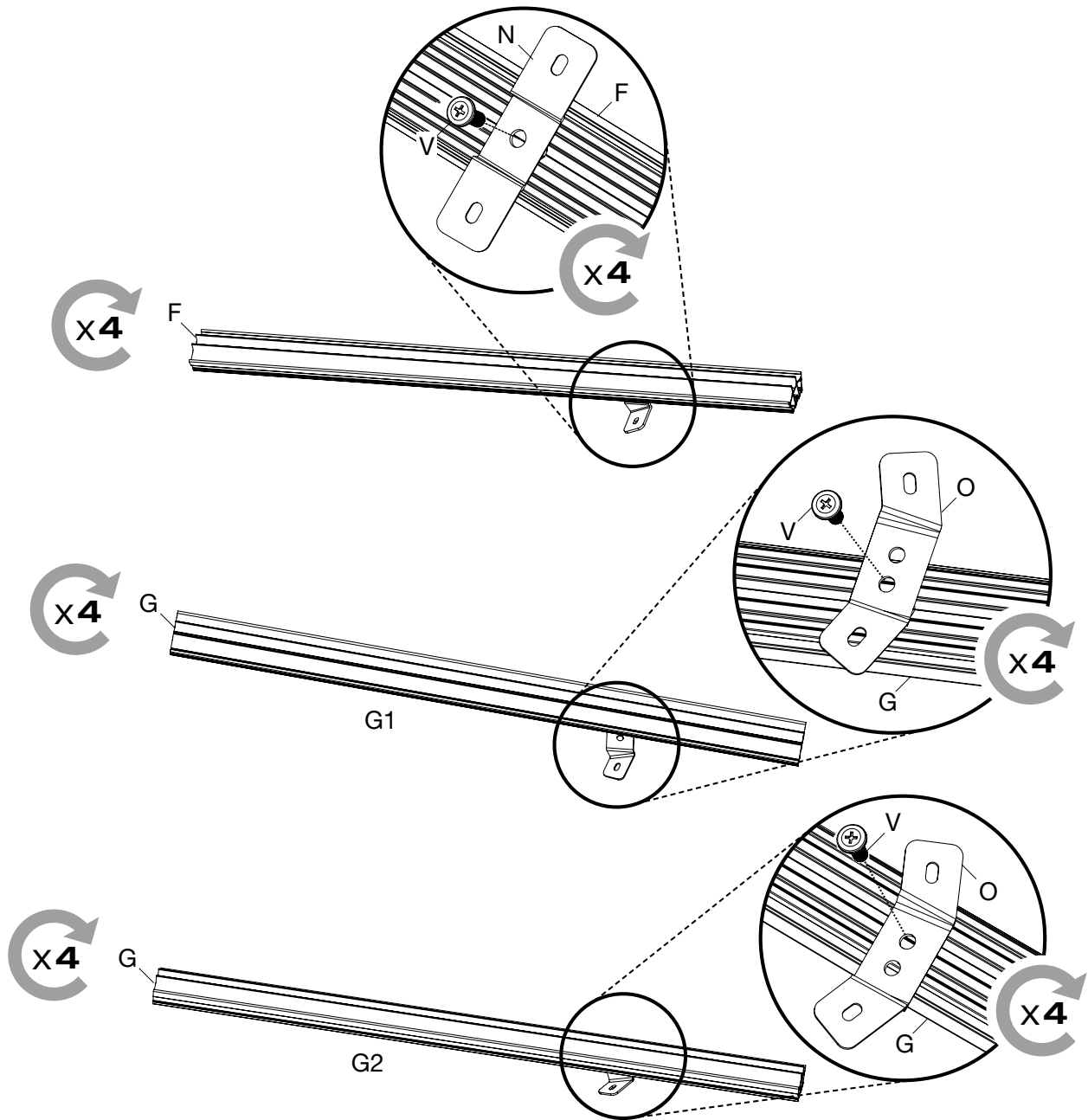

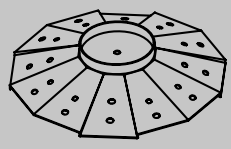
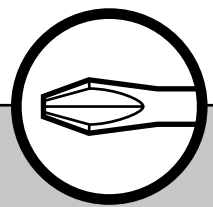
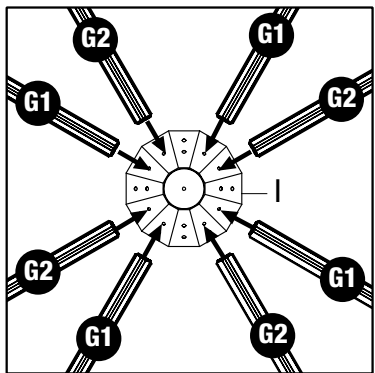
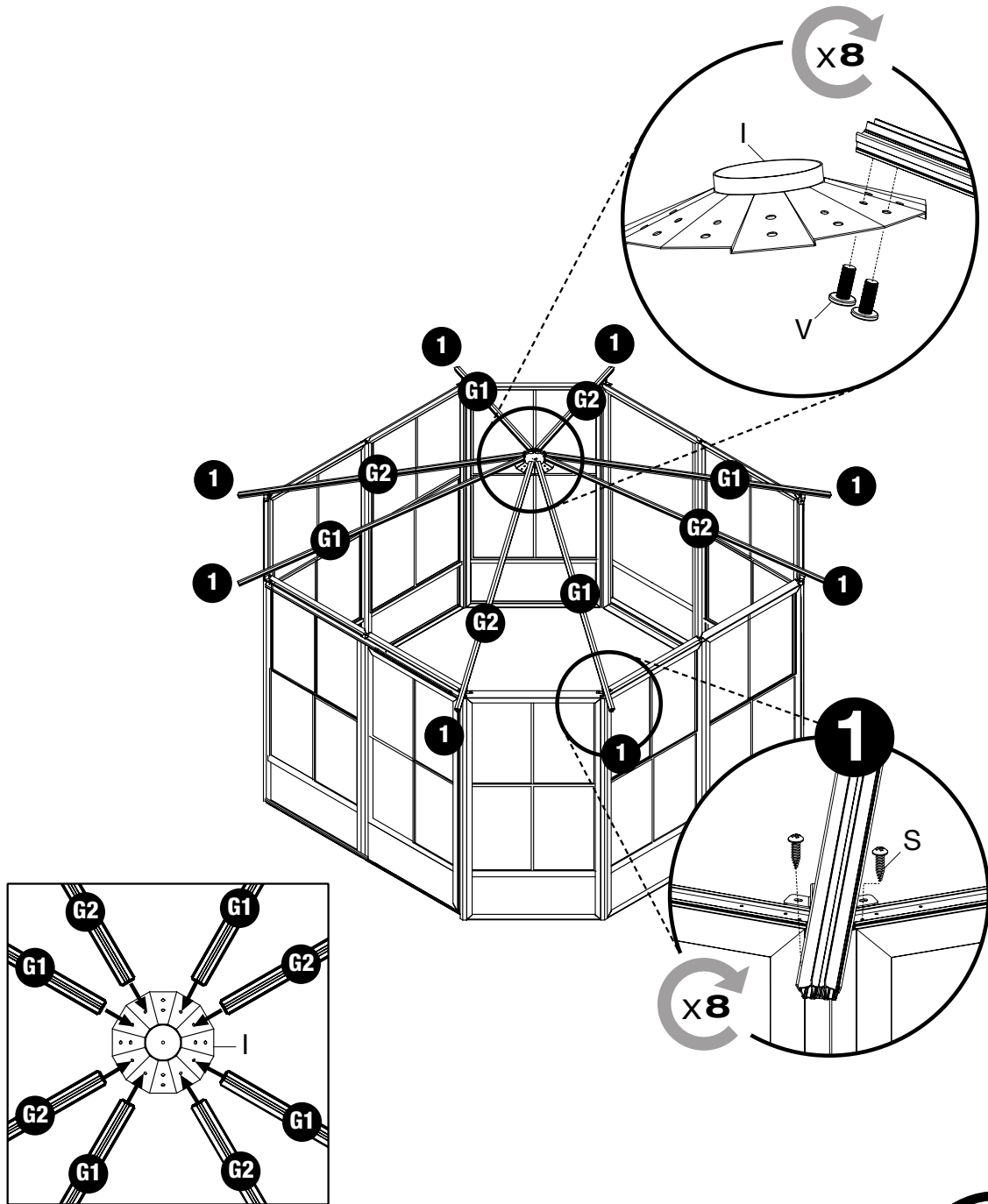

Ix1

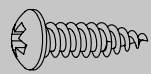

Sx16

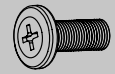

Vx16

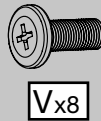
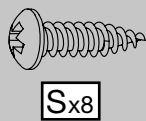
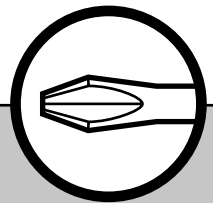
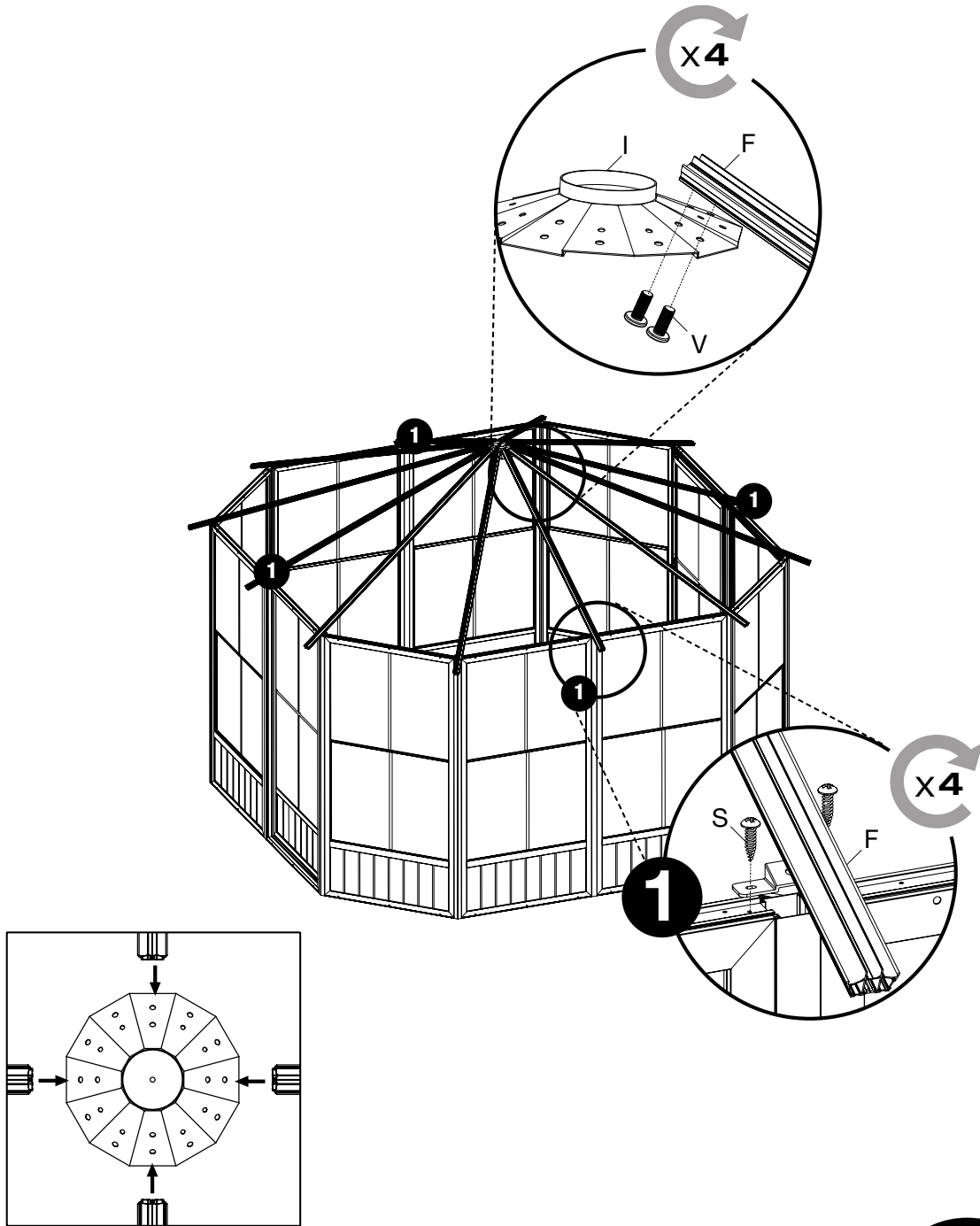

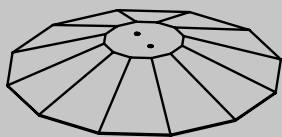
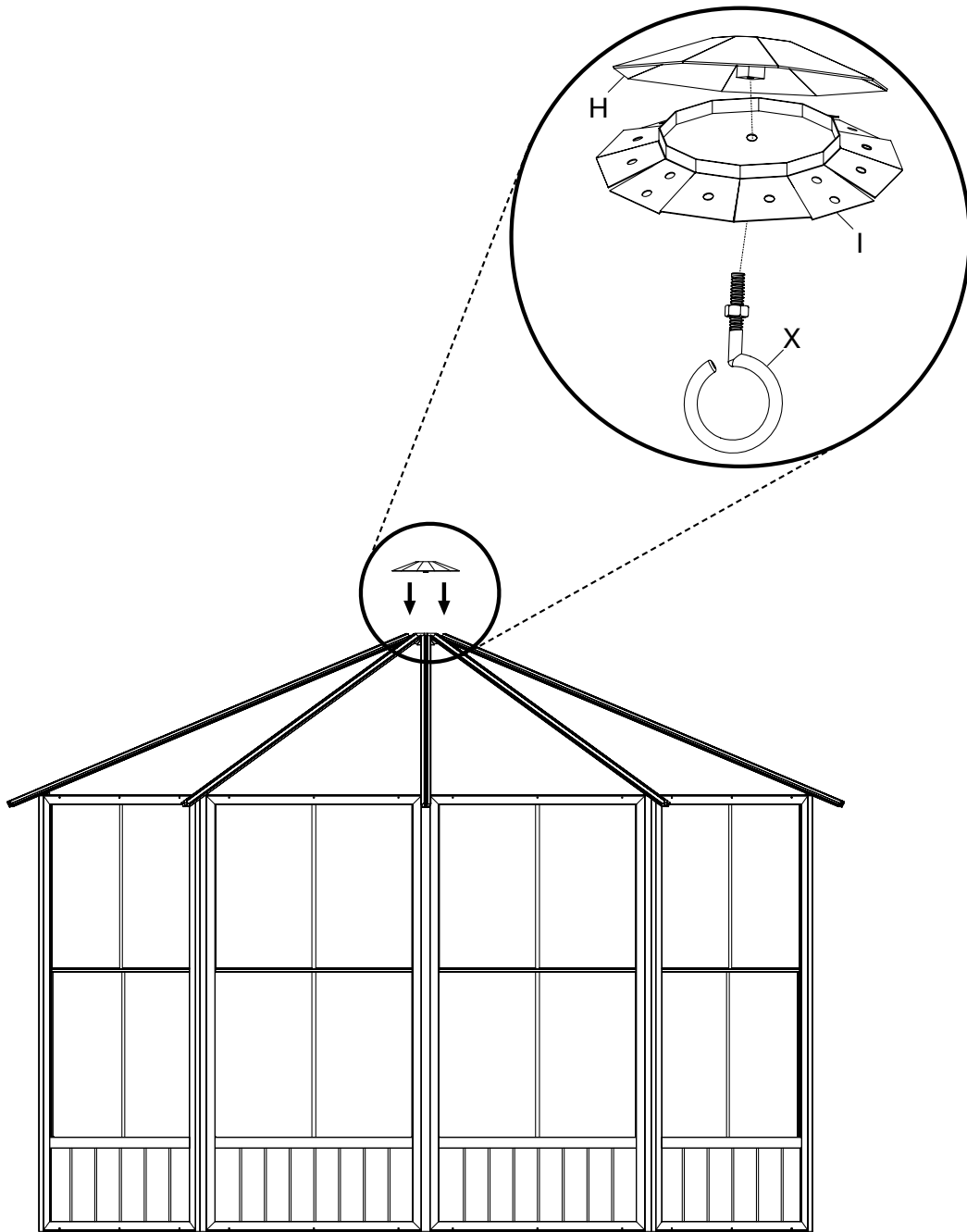

Hx1



Xx1

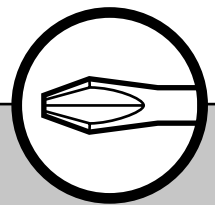

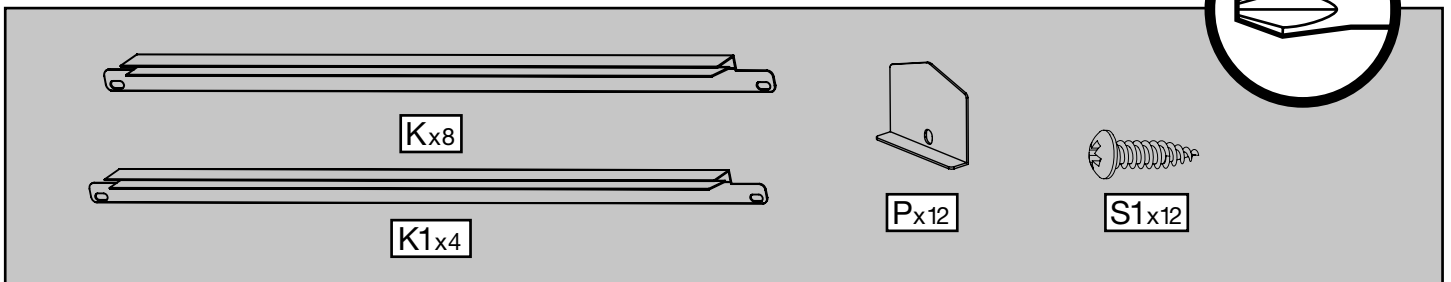
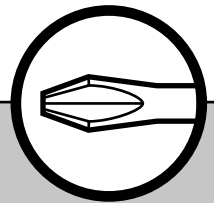
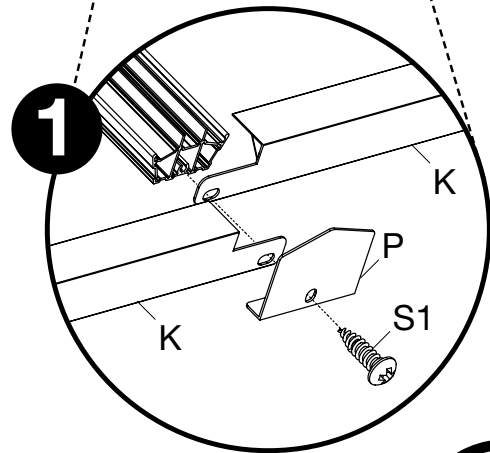
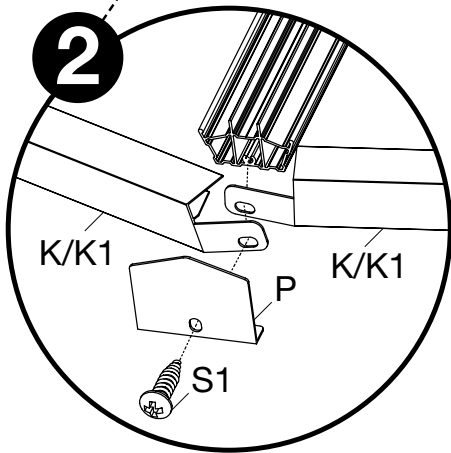
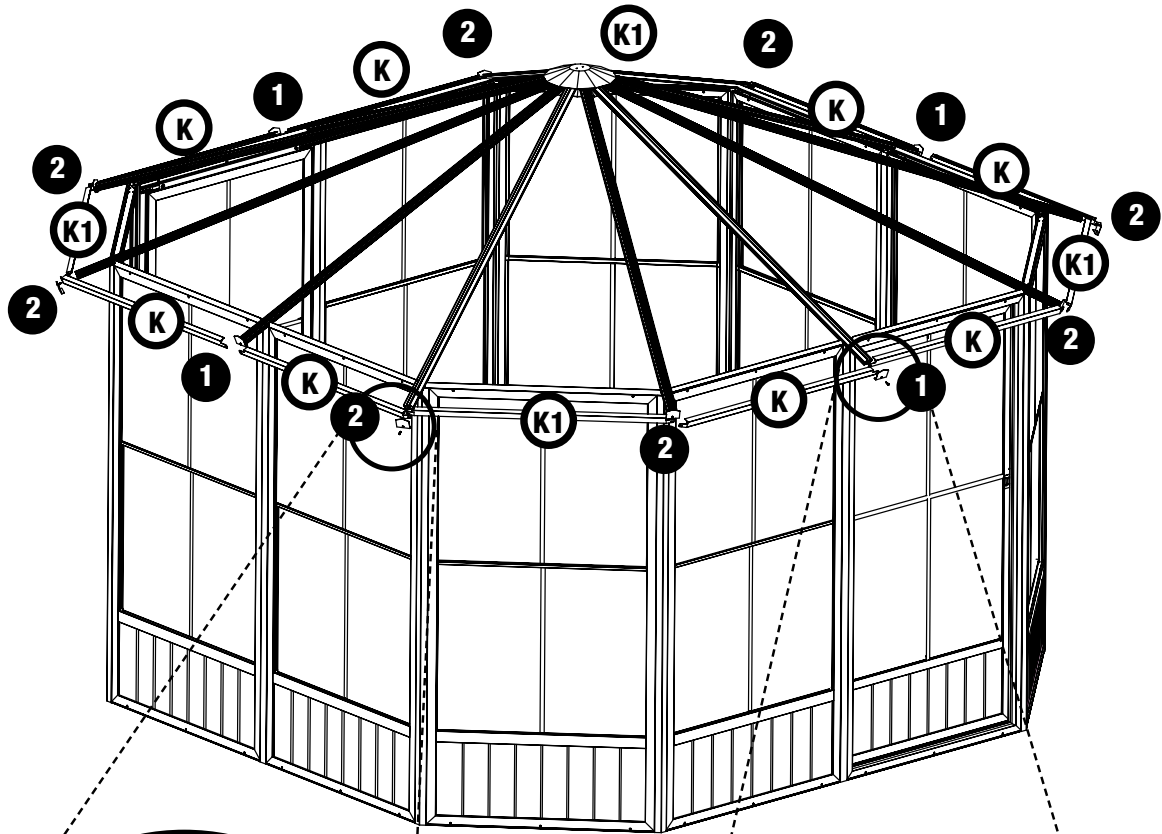

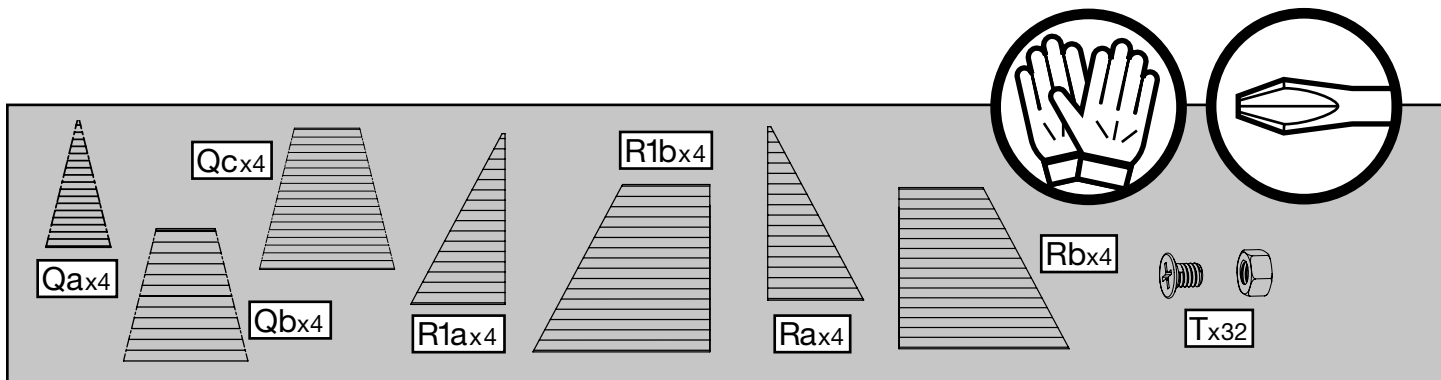
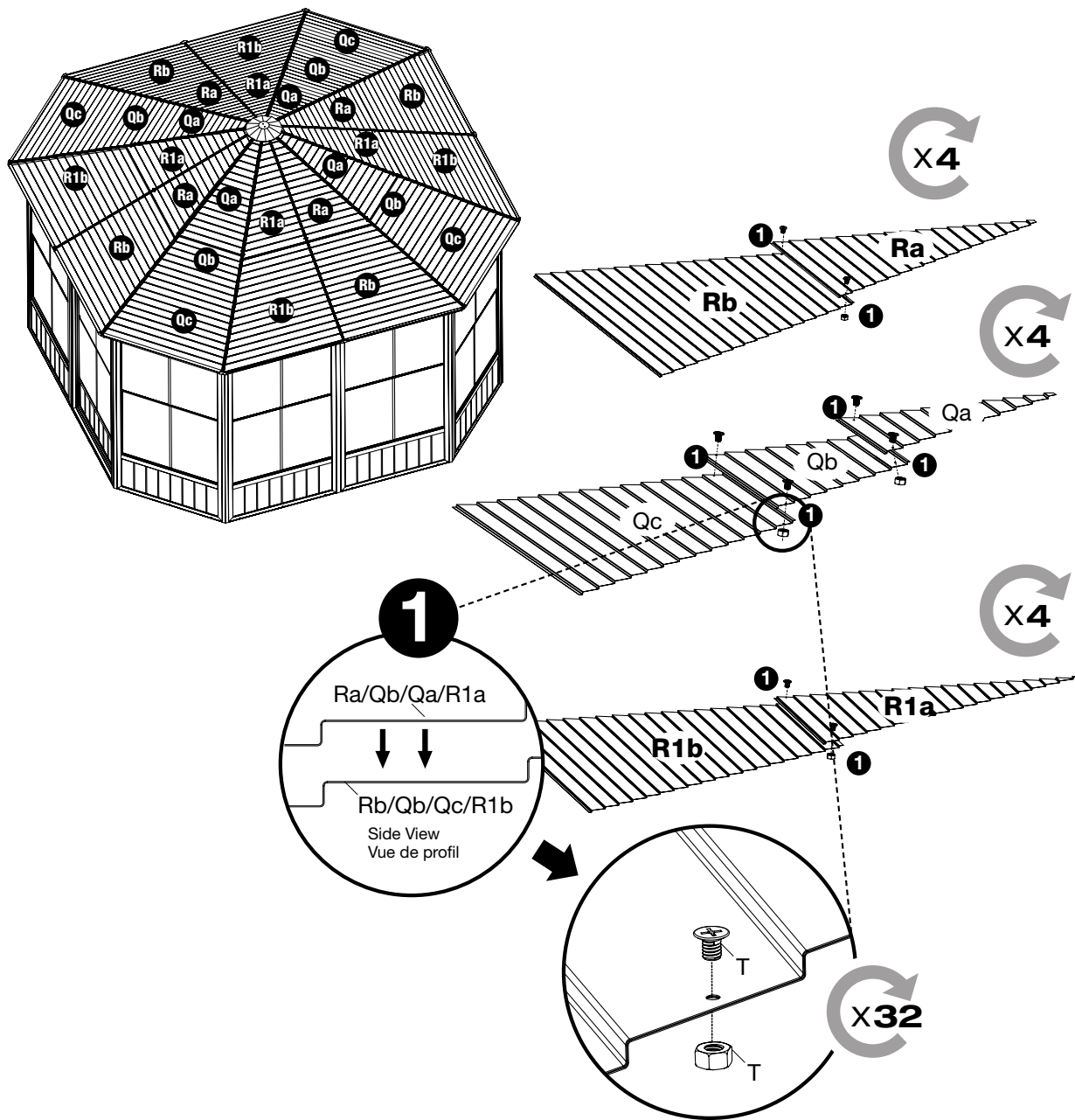

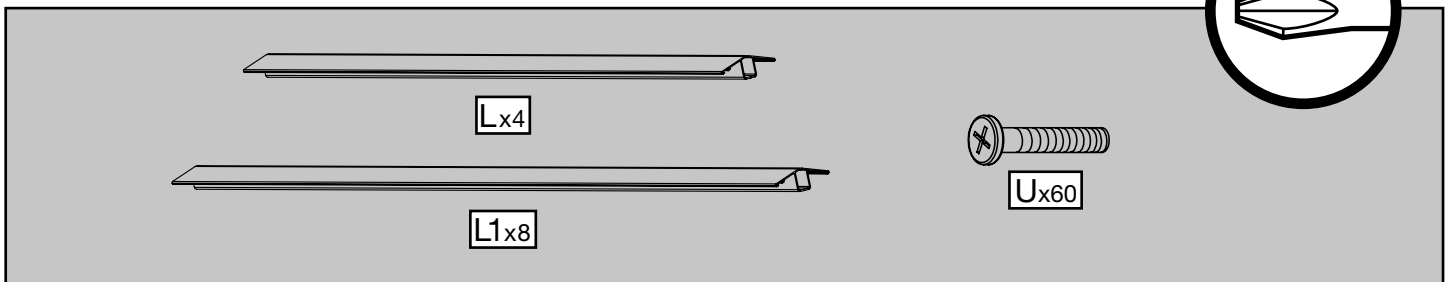
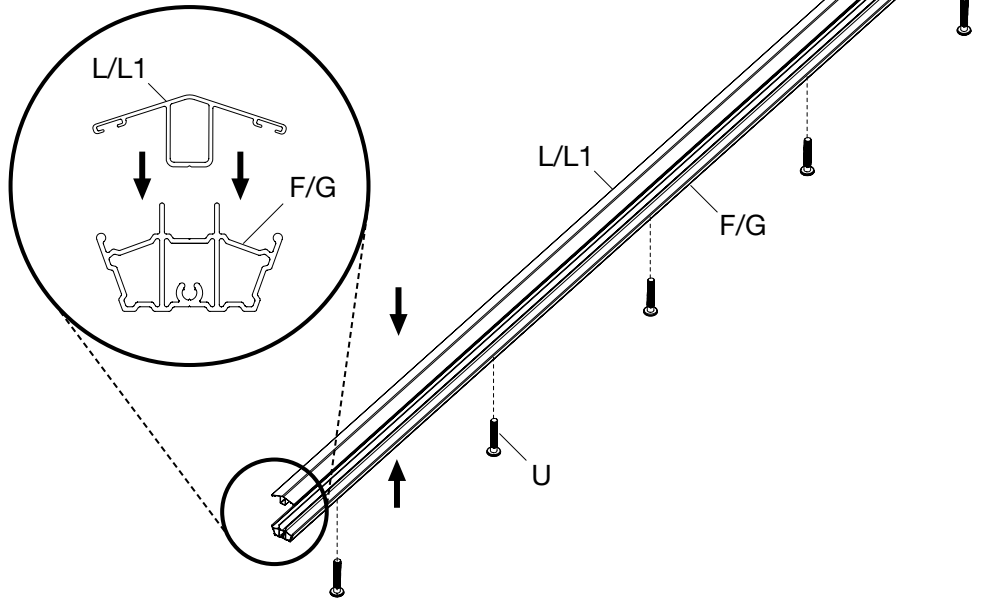
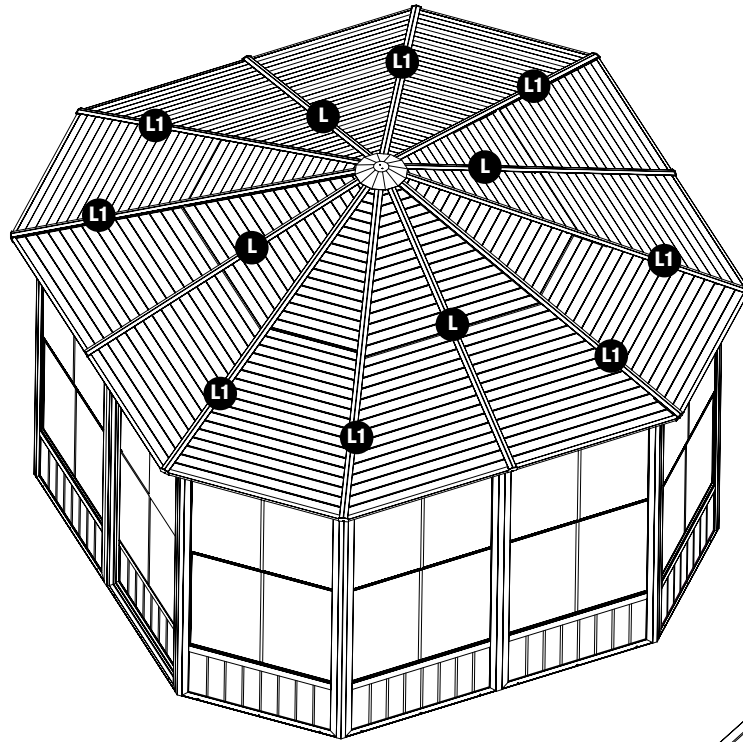

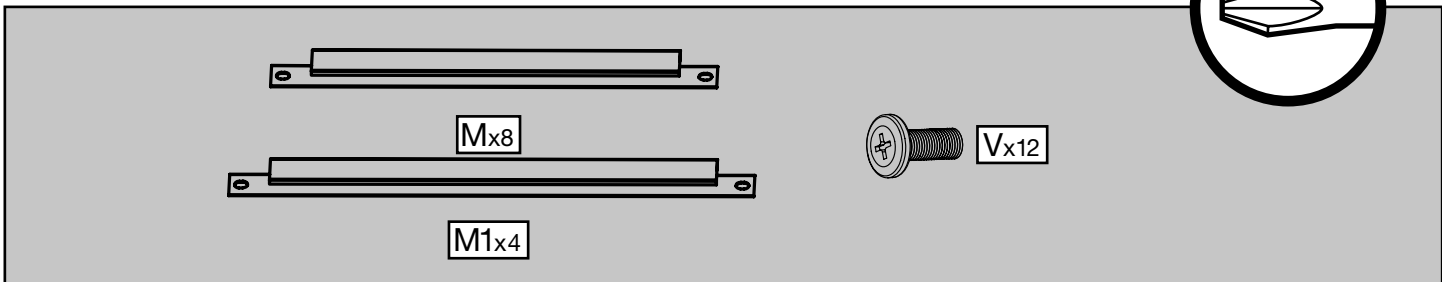
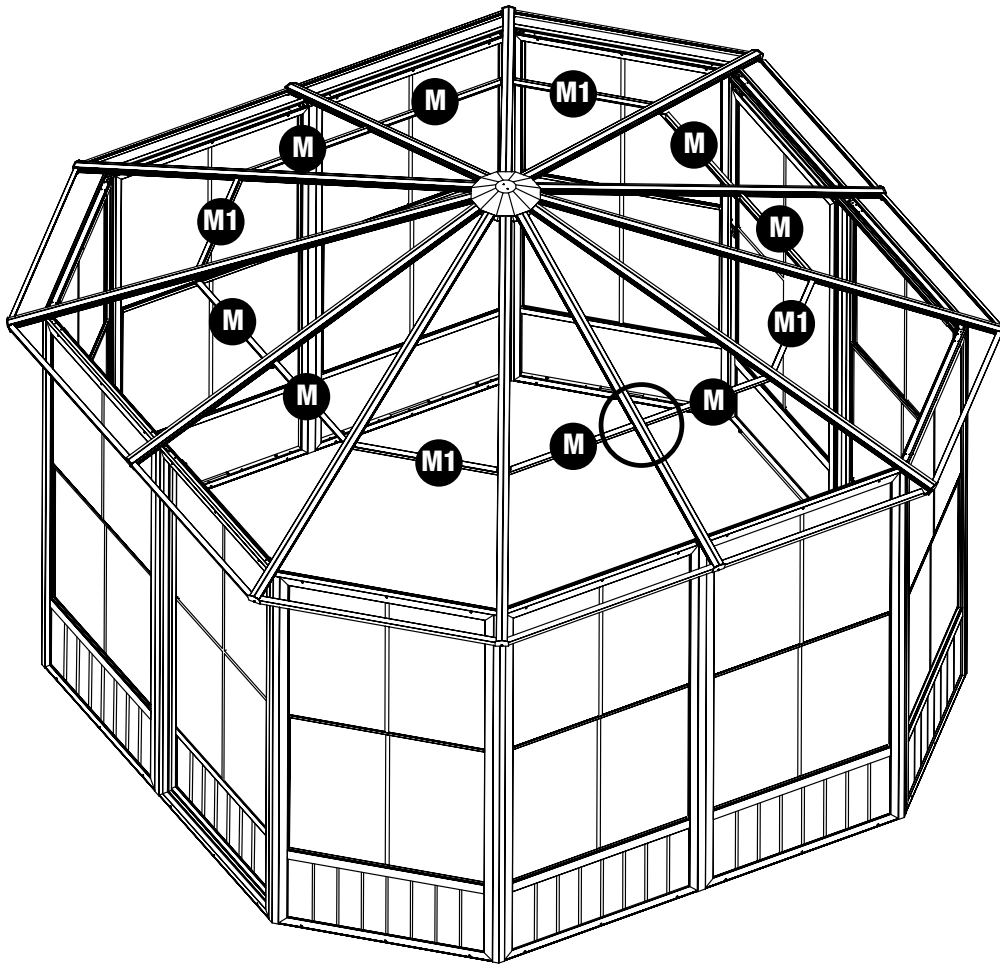

SOJAG ■ I
produits saisonniers • seasonal products