



Bathroom Sink

User Manual & Installation Instructions

IMPORTANT SAFETY INSTRUCTIONS
Carefully read the important information
regarding installation, safety and maintenance.
Keep these instructions for future reference.

MAAN3351-02
2021-12-12

Before You Begin

General Recommendations:

- Read installation and maintenance instructions, thoroughly before installation.
- Inspect your sink for any noticeable damage before installation.
- Be sure to use proper tools and always wear personal safety accessories for your protection.
- Check all local applicable plumbing and building codes.



WARNING:

Risk of personal injury or product damage. Handle with care. Material can break or chip if the product is handled carelessly. Metal edges may be sharp. Use gloves when handling.



IMPORTANT:

1. **Installation must be done by a qualified, licensed plumber.** The contractor must perform a dry fit prior to drilling holes in the countertop for the sink.
2. **Drill hole size in countertop for the lavatory is Φ 1 3/4 inch (4.4 cm).**
3. All vessel bowls are hand made. You may expect variations in color, texture and bowl symmetry. If you notice any obvious variation or defects, you should contact your retailer immediately.
4. Though resistant to breakage, vessel sinks can break or chip when a heavy object falls in or on them.

Product failure due to the disregard of the manufacturer's instructions or guidelines, is not covered under the Warranty.

Package Contents

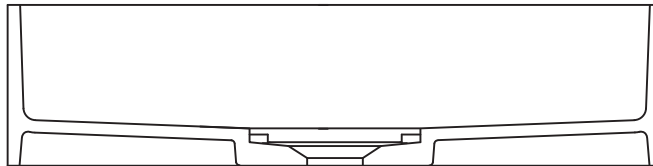

Lavatory

Required Tools

- Tape measure
- Pencil (NOT ink)
- Putty knife
- Scissors
- Adjustable wrenches
- Sealant drill and 1/2 inch (or larger) drill bits
- Plumber's putty or Caulk
- Caulking Gun
- Silicone adhesive sealant
- Rags
- Denatured alcohol
- Ear protection
- Eye protection
- Gloves
- Hacksaw/jigsaw
- Wood braces
- Framing square
- Shims

Be sure to use proper tools and always wear personal safety devices for your protection.

Removing Your Old Lavatory

- Turn off the water supply. This is done by closing the two shut-off valves located under the lavatory. If there are no shut-off valves leading to the lavatory, you must turn off the water at the main valve. This is usually located in the basement, garage or near the foundation on the outside of the house. It may also be near the water meter.
- Check to make sure the water is off, by turning on the faucet where you are working until the water stops flowing. If you have shut off the main valve in a two-story house or greater you should open the kitchen faucet and another faucet on the same level. Water will then drain from the entire line. This will help avoid spills.
- Be sure to close the faucets before you turn on the main valve again.
- Disconnect the drain pipes. Take off as many sections as possible between the lavatory and the wall or floor to facilitate removal.
- Place a basin under the work area to catch any water that may still be in the drain.

Installation

- Installation must be done by a qualified licensed plumber.
- Prior to installation please read the instructions thoroughly, confirm that all parts are included and visually inspect the unit for any defects.

STEP 1

Preparation

Please inspect your working surface, making sure it is level and clean.

STEP 2

Determine Layout

Determine the layout for the sink you desire. It is important to fully "dry" the position of the sink on the countertop. Aspects to note, but are not limited to:

- Leaving enough clearance behind the faucet for operation of the handle.
- Positioning the faucet so it does not interfere with the sink.
- Checking that the water flow from the faucet makes contact with the sink in the desired position.

STEP 3

Set Position

Mark and drill Φ 1 3/4 inch (4.4 cm) hole on countertop for drain placement.

STEP 4

Install the Sink

Make sure to use the intended style drain/pop-up. The vessel style bowl does not have an overflow. Therefore, the drain/pop-up needs to correspond appropriately.

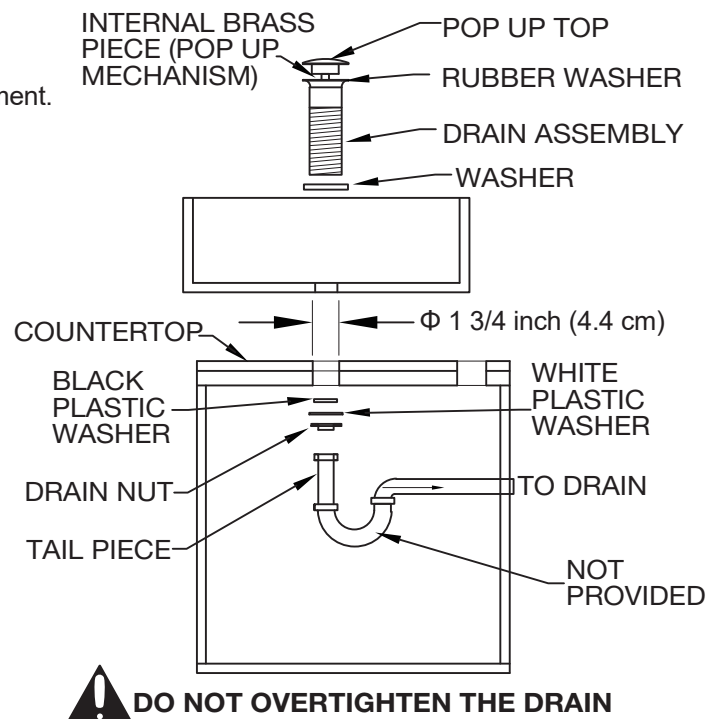
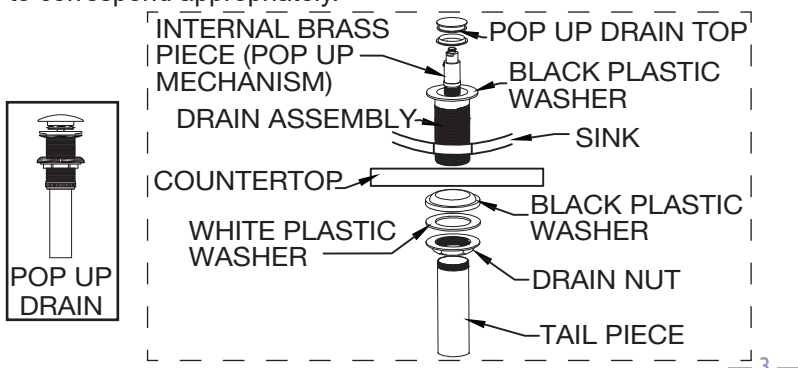

Care and Maintenance Instructions

To ensure that your installation project goes smoothly, please review these instructions.

- Your new lavatory is designed for years of trouble-free performance.
- Keep it looking new by cleaning it periodically with a soft cloth.
- Avoid abrasive cleaners, steel wool and harsh chemicals.