

# LifestyleGarden®

*Sustainable outdoor living*

ASSEMBLY INSTRUCTION  
MONTAGEANWEISUNG  
INSTRUCCIONES DE MONTAJE  
MONTAGEVEJLEDNING  
MONTERINGSANVISNING

MONTAGE INSTRUCTIE  
INSTRUCTIONS DE MONTAGE  
ISTRUZIONI DI MONTAGGIO  
ΟΔΗΓΙΑ ΣΥΝΑΡΜΟΛΟΓΗΣΗΣ

## OPAL



**VIDEO**  
**You Tube**

## **IMPORTANT, SAVE FOR FUTURE CONSULTATION: READ CAREFULLY**

For Hospitality

## **WICHTIG, BITTE ZU REFERENZZWECKEN AUFHEBEN: AUFMERKSAM LESEN**

Für die Gastlichkeit

## **IMPORTANTE, GUARDAR PARA FUTURA CONSULTA: LEER DETENIDAMENTE**

Para el sector de la hostelería

## **VIGTIGT, GEM TIL SENERE BRUG: LÆS OMHYGGELIGT**

Til restaurationsbranchen

## **VIKTIGT, SPARA FÖR FRAMTIDA BRUK: LÄS NOGA**

För hotell- och restaurangbranschen

## **BELANGRIJK, BEWAREN VOOR TOEKOMSTIGE RAADPLEGING: ZORGVULDIG LEZEN**

Voor de horeca

## **IMPORTANT, CONSERVER CE DOCUMENT POUR TOUTE CONSULTATION ULTÉRIEURE : LIRE ATTENTIVEMENT**

Pour l'hôtellerie

## **IMPORTANTE: CONSERVARE PER FUTURE CONSULTAZIONI. LEGGERE ATTENTAMENTE**

Per uso alberghiero

## **ΣΗΜΑΝΤΙΚΟ, ΦΥΛΑΞΤΕ ΓΙΑ ΜΕΛΛΟΝΤΙΚΗ ΑΝΑΦΟΡΑ: ΔΙΑΒΑΣΤΕ ΠΡΟΣΕΚΤΙΚΑ**

Για Φιλοξενία

Manufactured by / Produziert von / Producido Por / Produceret af / Producerad av /  
Gemaakt door / Fabriqué par / Prodotto da / Κατασκευαστής  
Scancom International A/S  
Gl. Banegårdsplads 10, 4220 Korsør Denmark



# LifestyleGarden®

*Sustainable outdoor living*



SU-SC-ST-0508

X 1

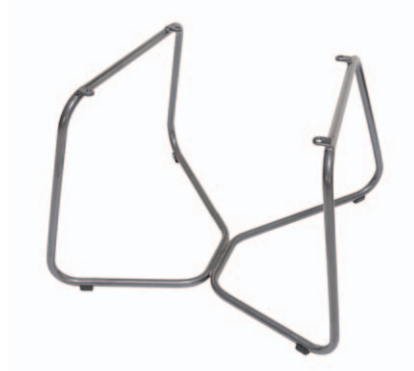

SU-SC-AS-0174

X 1

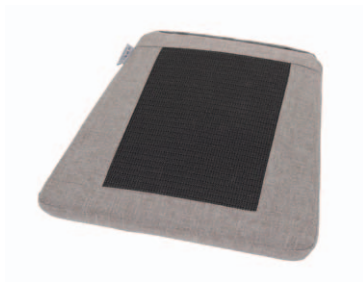

X 1



X 1



HW-ST-02-022

X 4



HW-ST-07-063

X 8



HW-ST-03-010

X 4



HW-ST-18-009

X 1



HW-MM-18-026

X 1



01



02

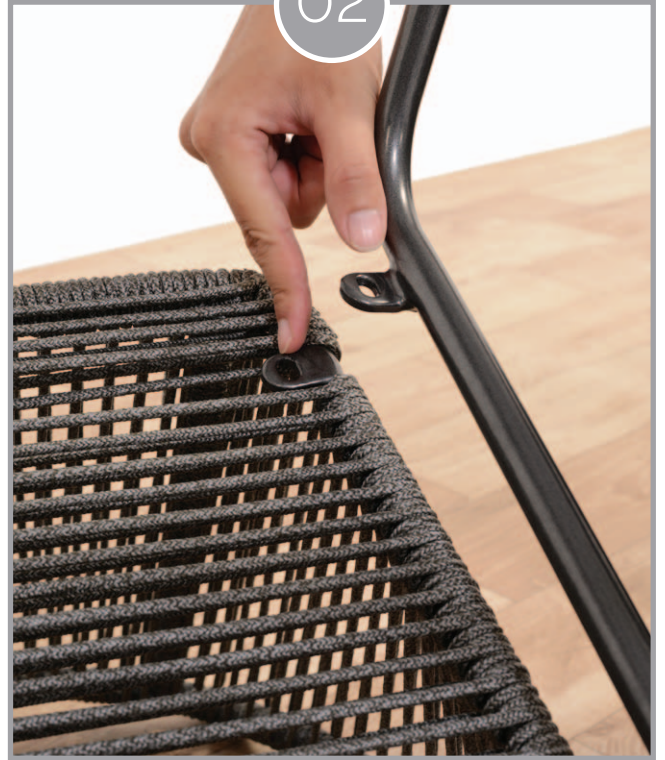

03



04

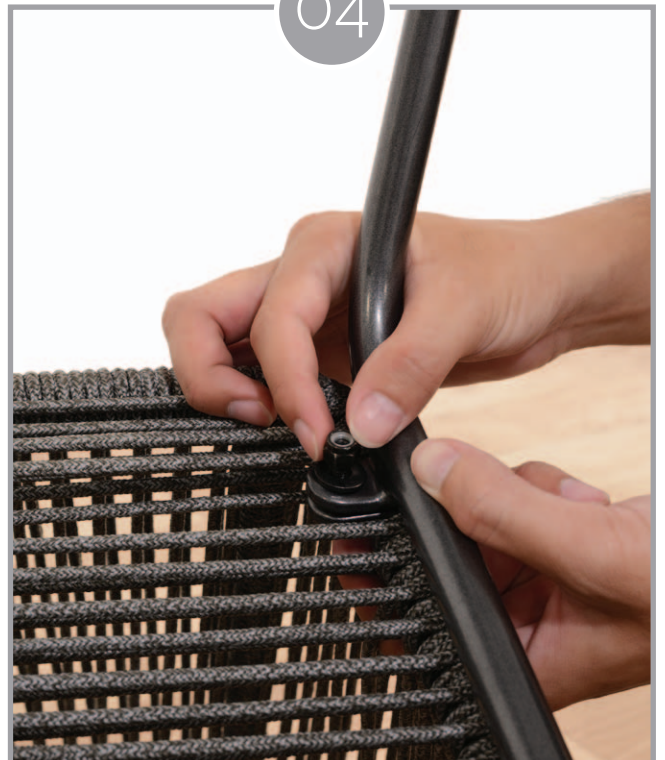

05



06



07



08



09



10



# LifestyleGarden®

*Sustainable outdoor living*



# OPAL COLLECTION



## Furniture covers



## Maintenance

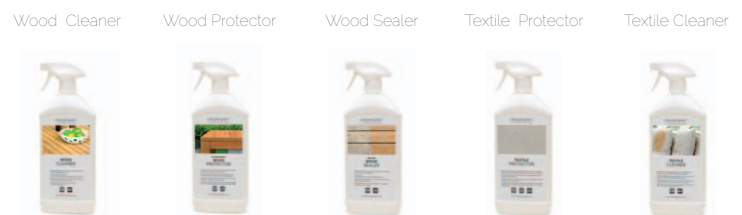



ASSEMBLY INSTRUCTION  
MONTAGEANWEISUNG  
INSTRUCCIONES DE MONTAJE  
MONTAGEVEJLEDNING  
MONTERINGSANVISNING

MONTAGE INSTRUCTIE  
INSTRUCTIONS DE MONTAGE  
ISTRUZIONI DI MONTAGGIO  
ΟΔΗΓΙΑ ΣΥΝΑΡΜΟΛΟΓΗΣΗΣ

## OPAL

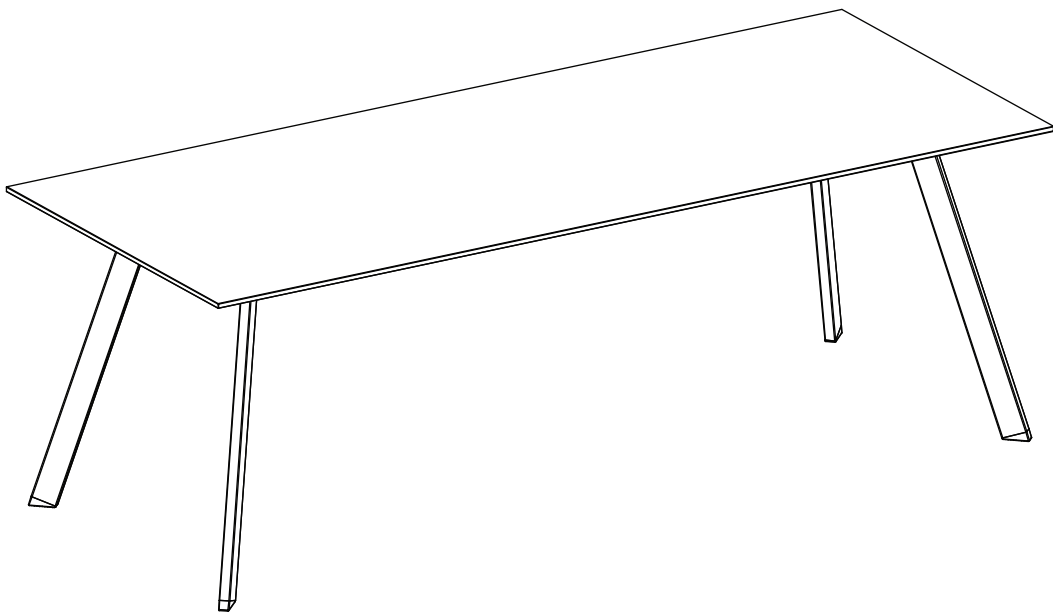

**VIDEO**

You Tube

**IMPORTANT, SAVE FOR FUTURE CONSULTATION: READ CAREFULLY**

For Hospitality

**WICHTIG, BITTE ZU REFERENZZWECKEN AUFHEBEN: AUFMERKSAM LESEN**

Für die Gastlichkeit

**IMPORTANTE, GUARDAR PARA FUTURA CONSULTA: LEER DETENIDAMENTE**

Para el sector de la hostelería

**VIGTIGT, GEM TIL SENERE BRUG: LÆS OMHYGGELIGT**

Til restaurationsbranchen

**VIKTIGT, SPARA FÖR FRAMTIDA BRUK: LÄS NOGA**

För hotell- och restaurangbranschen

**BELANGRIJK, BEWAREN VOOR TOEKOMSTIGE RAADPLEGING: ZORGVULDIG LEZEN**

Voor de horeca

**IMPORTANT, CONSERVER CE DOCUMENT POUR TOUTE CONSULTATION ULTÉRIEURE : LIRE ATTENTIVEMENT**

Pour l'hôtellerie

**IMPORTANTE: CONSERVARE PER FUTURE CONSULTAZIONI. LEGGERE ATTENTAMENTE**

Per uso alberghiero

**ΣΗΜΑΝΤΙΚΟ, ΦΥΛΑΞΤΕ ΓΙΑ ΜΕΛΛΟΝΤΙΚΗ ΑΝΑΦΟΡΑ: ΔΙΑΒΑΣΤΕ ΠΡΟΣΕΚΤΙΚΑ**

Για Φιλοξενία

# LifestyleGarden®

*Sustainable outdoor living*

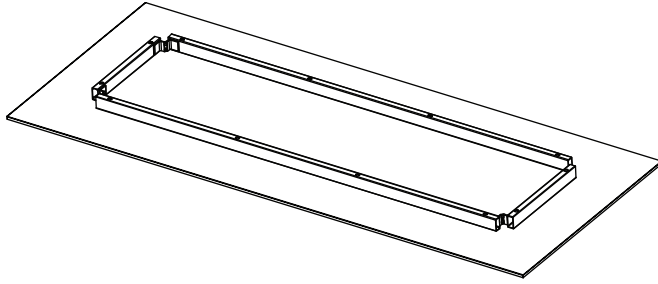

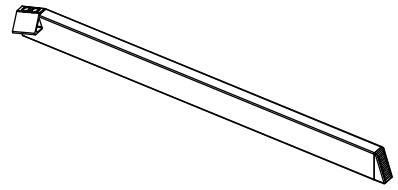

(A)

SU-TB-TF-2398  
x1



(B)

SU-TB-LF-1698  
x4

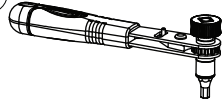
<p>①</p>  <p>HW-ST-02-054 (8x40) x8</p>	<p>②</p>  <p>HW-ST-07-062 (8,5x12,5x1,5) x8</p>	<p>③</p>  <p>HW-ST-07-044 (8,5x18x1) x8</p>	<p>④</p>  <p>HW-MM-18-026 (125) x1</p>
--	--	--	---



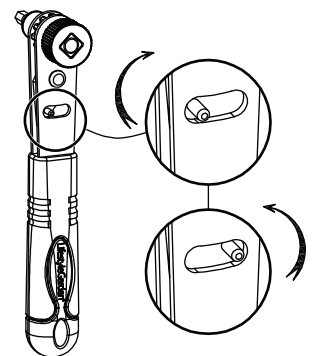
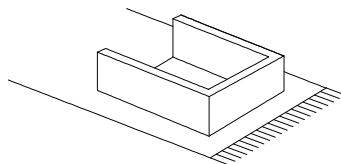
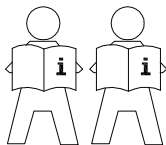

20 min

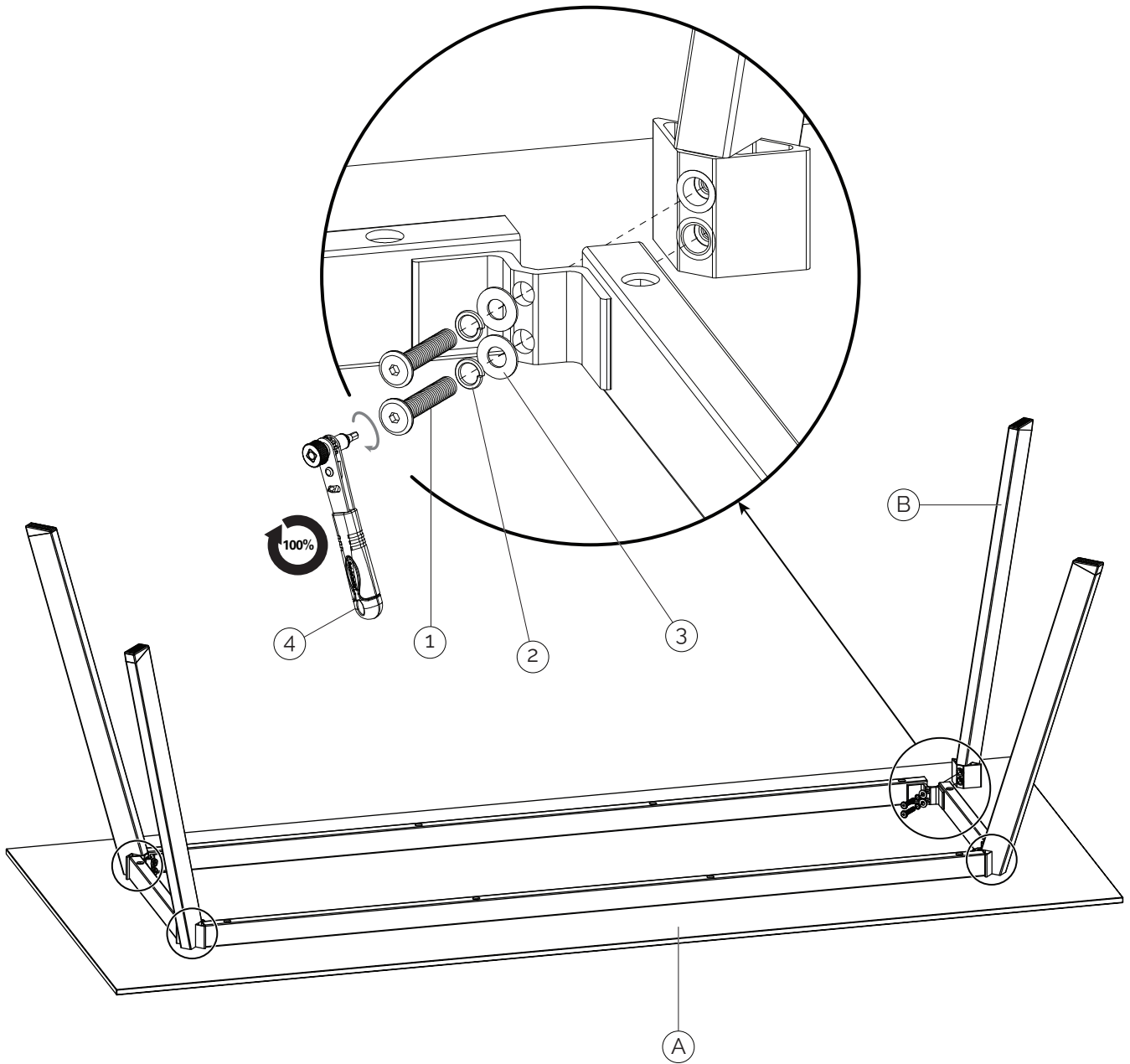

1

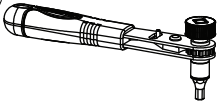

<p>①</p>  <p>HW-ST-02-054 (8x40) <b>x8</b></p>	<p>②</p>  <p>HW-ST-07-062 (8,5x12,5x1,5) <b>x8</b></p>	<p>③</p>  <p>HW-ST-07-044 (8,5x18x1) <b>x8</b></p>	<p>④</p>  <p>HW-MM-18-026 (125) <b>x1</b></p>
---	---	---	--



# LifestyleGarden®

*Sustainable outdoor living*



# LifestyleGarden®

*Sustainable outdoor living*

<https://www.lifestylegarden.com/warranty/>



[www.lifestylegarden.com](http://www.lifestylegarden.com)



## Furniture covers



## Maintenance

Wood Cleaner



Wood Protector



Wood Sealer



Textile Protector



Textile Cleaner



LifestyleGarden®  
www.lifestylegarden.com