

## ASSEMBLING YOUR PUMP

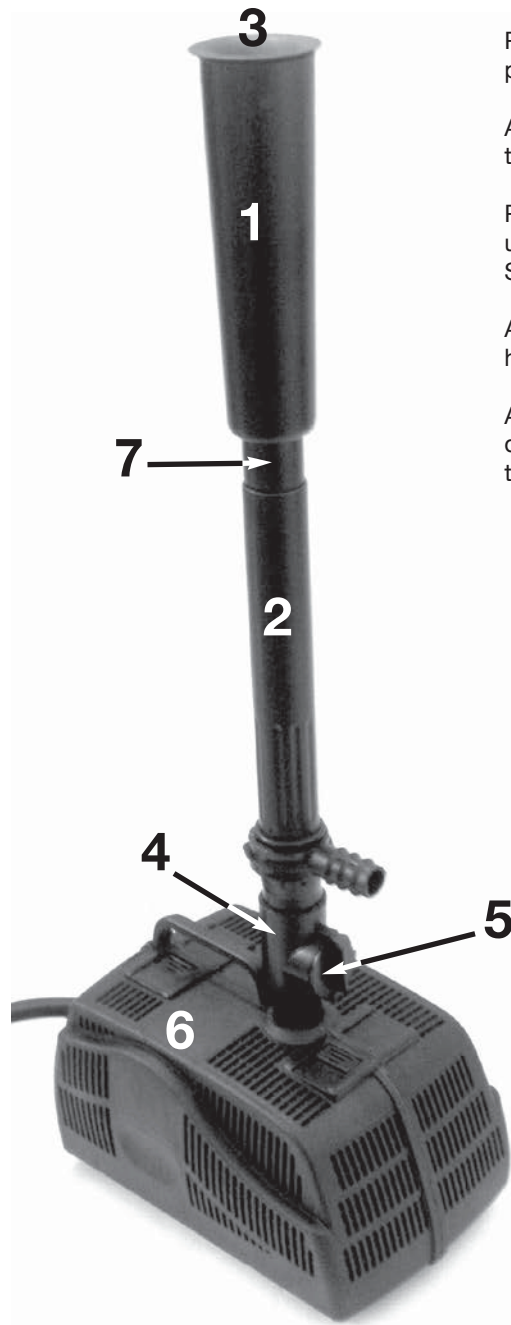

Place desired fountain head (1) on riser (2) pushing down until snug.

Adjust the size of the waterbell by turning the round piece (3) on top.

Put riser (2) into diverter (4), pushing down until the hole is no longer visible. Some light force may be required.

Adjust the flow of water to your fountain head by turning the diverter knob (5).

Attach all to the pump (6) by pushing down the diverter into the hole located on top of the pump (6).

### FOR A HIGHER FOUNTAIN HEAD

- Extend the tube extension (7) found inside the riser (2).

### FOR A WATERFALL

- Place clamp over tubing.
- Fit tubing over diverter.
- Tighten clamp over tubing with a flat head screwdriver.



## WARRANTY

This KOOLATRON product is warranted to the retail consumer for 90 days from date of retail purchase, against defects in material and workmanship.

### WHAT IS COVERED

- Replacement parts and labor.
- Transportation charges to customer for the repaired product.

### WHAT IS NOT COVERED

- Commercial or industrial use of this product.
- Damage caused by abuse, accident, misuse, or neglect.
- Transportation of the unit or component from the customer to Koolatron.

### IMPLIED WARRANTIES

Any implied warranties, including the implied warranty of merchantability are also limited to duration of 90 days from the date of retail purchase.

### WARRANTY AND SERVICE PROCEDURE

Keep the original, dated, sales receipt with this manual. If you have a problem with your unit, or you require replacement parts, please telephone the following number for assistance:

1-800-265-8456

A Koolatron Master Service Centre must perform all warranty work. Service after warranty may be obtained at a Master Service Centre or at an authorized service dealer. Purchase Receipt is required to establish warranty eligibility.

Koolatron has Master Service Centres at these locations:

U.S.A. - 4330 Commerce Dr., Batavia, NY 14020-4102

Canada - 139 Copernicus Blvd., Brantford, ON N3P 1N4



www.koolatron.com

©2020 Koolatron, Inc. All rights reserved.

All specifications are subject to change without notice.

Made in China



## 84-GALLON POND KIT



**KSPK-84  
Installation Manual**

### NOTE

Do NOT plug in your pump until it is fully immersed in water. Never run your pump dry!

## FEATURES

The popularity of backyard ponds continues to grow at a vigorous pace. This kit includes everything you need to construct a beautiful, low maintenance water garden.

- 8ft x 10ft non-toxic Pond Liner
- 200gph Filter Free Pump with protective shell
- Water-bell Fountain Head
- 3-tier Fountain Head
- Telescopic Riser
- Diverter with flow control
- 2 silk Water Lilies
- 1 Solar Glo - floating pond light
- Installation Manual

## ELECTRICAL

- Pump Voltage: 110V
- Pump Capacity: 200 gallons/hour
- Pump Power Consumption: 12W
- Pump cULus: E 204083

## INSTALLATION

### YOU WILL NEED

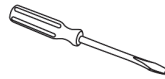

flat head screwdriver



rope

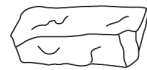

edging material (i.e. rock)

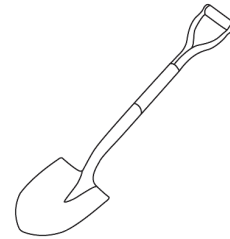

garden shovel

### TO START

Once you gathered everything you need, it is time to start. It is important to take the time to design your pond before beginning. Keep in mind the depth and width of your pond compared to the size of liner you have to work with. Once you have a style and size in mind mark the shape using heavy rope. Be mindful of buried wires and pipes. Ensure electric cable will reach pump.

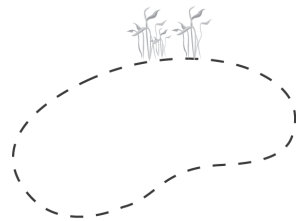

## INSTALLATION (cont.)

### DIGGING

Start by removing the sod in the area you have marked with the rope. It is best to start digging from the middle out. This will allow you to easily remove dirt with a wheelbarrow. When digging, keep in mind that most ponds have plant shelves. These shelves are traditionally 6" below water level and should be at a 20° angle for support.

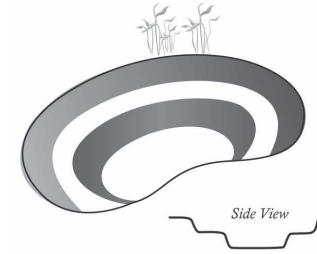

### PREPARATION

To prepare the hole for the liner you must remove any sharp stones or roots. Sharp objects could puncture or ruin your liner. You may put 5-8cm (2-3in) of sand at the bottom of the pond, but it is not necessary. Once the area is clear, place the provided liner inside the hole, friends or family may be required for help. Hold the liner in place using some of the rocks for the edging.



### ADDING WATER

Your pond is now ready to fill with water. As the pond is filling you may want to smooth major wrinkles in the liner by pulling and shifting the liner. Once the pond is about half full remove some of the anchor stones to allow the liner to sink to the bottom of the hole.

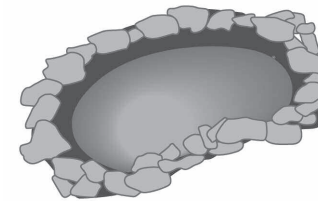

## INSTALLATION (cont.)

### FINISHING

Once your pond is full you should use some long nails to secure the liner in place. Cut off any excess liner. Using decorative rocks around the edge will help hold the liner in place and give your pond a more natural look. Place the pump in your pond, then plug it in. If adding plants to your pond you should wait 48 hours after completion, and if adding fish you should wait 72 hours after completion.

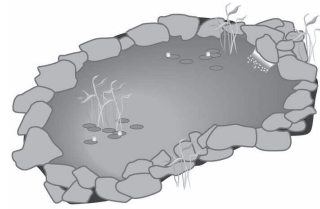

### DECORATE AND ENJOY!

## CARE AND MAINTENANCE

With the proper care and maintenance this pond will last a very long time and look more beautiful with each year. Simple steps can be taken to ensure a long life from your pond. Clean your pump regularly to prevent build up. If your pump stops working, unplug it and take it out of the pond. Follow the care instructions given in your pump kit box. If there is a lot of calcium build up on your pump it may stop working. To clean, simply place the pump motor (remove attachments) in vinegar water then plug it in. Let the pump run for about 30 seconds. Once cleaned rinse your pump with water and place back in pond.

### WINTER CARE

Getting ready for winter may seem like an arduous task, but if the right steps are taken it can be very beneficial to your pond and any life within it. During the fall months the pond should be kept free from fallen leaves and other debris that may rot and cause harmful toxins in your pond. Once the temperature reaches 43°F (6°C) outside, it is time to winterize your pond. The first step is to remove any submersible pumps and clean them for winter storage. If you have fish the next step is to add a Pond Breather or Floating Pond Heater to circulate oxygen and release toxic gases. After the pond has been winterized and the ice has formed, there isn't much work to be done during the winter months. The fish will naturally go to deeper depths of the pond where the water is warmer and require no feeding during these cold months. Never allow water to freeze in the pump.



**WARNING!** This product contains chemicals known to the State of California to cause cancer, and birth defects or other reproductive harm. [www.P65Warnings.ca.gov](http://www.P65Warnings.ca.gov)