



# KING KING CANADA

## WET•DRY VACUUM



MODEL: 8520LP

# INSTRUCTION MANUAL

COPYRIGHT © 2007 ALL RIGHTS RESERVED BY KING CANADA TOOLS INC.



# WARRANTY INFORMATION & SAFETY RULES FOR WET/DRY VACUUMS

**2-YEAR  
LIMITED WARRANTY  
FOR THIS WET/DRY VACUUM**

**KING CANADA TOOLS  
OFFERS A 2-YEAR LIMITED WARRANTY  
FOR NON-COMMERCIAL USE.**

## **PROOF OF PURCHASE**

Please keep your dated proof of purchase for warranty and servicing purposes.

## **REPLACEMENT PARTS**

Replacement parts for this tool are available at our authorized KING CANADA service centers across Canada. For servicing, contact or return to the retailer where you purchased your product along with your proof of purchase.

## **LIMITED TOOL WARRANTY**

KING CANADA makes every effort to ensure that this product meets high quality and durability standards. KING CANADA warrants to the original retail consumer a 2-year limited warranty as of the date the product was purchased at retail and that each product is free from defects in materials. Warranty does not apply to defects due directly or indirectly to misuse, abuse, negligence or accidents, repairs or alterations and lack of maintenance. KING CANADA shall in no event be liable for death, injuries to persons or property or for incidental, special or consequential damages arising from the use of our products. To take advantage of this warranty, the product or part must be returned for examination by the retailer. Shipping and handling charges may apply. If a defect is found, KING CANADA will either repair or replace the product.

## **ITEMS NOT COVERED UNDER WARRANTY**

Accessories supplied with this vacuum such as the hose, 10" floor sweep, crevice tool, 20L dust bag, foam filter and re-usable filter are not covered under warranty and are available as optional accessories at your nearest King Canada distributor.

---

## **IMPORTANT SAFETY RULES FOR WET•DRY VACUUMS**

**VOLTAGE WARNING:** Before connecting this vacuum to a power source (receptacle, outlet, etc.) be sure the voltage supplied is the same as that specified on the nameplate. A power source with voltage greater than the specified voltage on nameplate can result in **SERIOUS INJURY** to the user - as well as damage to the motor. If in doubt **DO NOT PLUG IN THE VACUUM**. Using a power source with voltage less than the nameplate is also harmful to the motor.

- 1. KNOW YOUR VACUUM.** Read and understand the owners manual and labels affixed to the vacuum. Learn its application and limitations as well as its specific potential hazards.
- 2. GROUND THE VACUUM. THIS VACUUM MUST BE GROUNDED.** This vacuum is equipped with an approved 3-conductor cord and a 3-prong grounding type plug to fit the proper grounding type receptacle. The green conductor in the cord is the grounding wire. **NEVER** connect the green wire to a live terminal. See grounding instructions.
- 3. WEAR PROPER APPAREL.** Do not wear loose clothing, gloves, neckties or jewelry (rings, watch) because suction force could get them caught in the vacuum. Wear protective hair covering to contain long hair. Roll up long sleeves above the elbows.
- 4. Do NOT expose to rain, this vacuum must be stored indoors.**
- 5. Do not handle the electrical plug or vacuum with wet hands.**
- 6. Never use this vacuum with any opening blocked, keep opening free of dust, hair, lint or anything that will restrict air flow.**
- 7. Never vacuum anything that is on fire, burning or smoking such as matches, cigarettes or hot ashes. Never vacuum flammable or combustible liquids such as gasoline, electrical devices could produce sparks which can cause a fire or explosion! Never vacuum toxic or hazardous materials.**
- 8. Never use this vacuum without dust bag and/or filters installed.**
- 9. Never vacuum coal ash, cement or drywall dust without a re-usable filter or dust bag in place or you could damage the motor or the material could be exhausted back into the air. When vacuuming drywall dust, a high efficiency drywall filter and dust bag must be used to prevent serious motor damage. These high efficiency accessories are available and are listed in this manual.**

# GETTING TO KNOW YOUR VACUUM, ELECTRICAL INFO & SPECIFICATIONS



## GETTING TO KNOW YOUR VACUUM

- 1) Cover/motor assembly
- 2) Cover latch (2)
- 3) waterproof switch
- 4) Top carry handle
- 5) On-board accessory storage
- 6) Threaded inlet
- 7) Blower outlet
- 8) Tank
- 9) Cord wrap posts
- 10) Foam filter
- 11) Re-usable filter
- 12) 20L Dust bag
- 13) 3pc. Extension wands
- 14) Thread-on hose
- 15) 10" floor sweep
- 16) Crevice tool
- 17) Blower hose adaptor

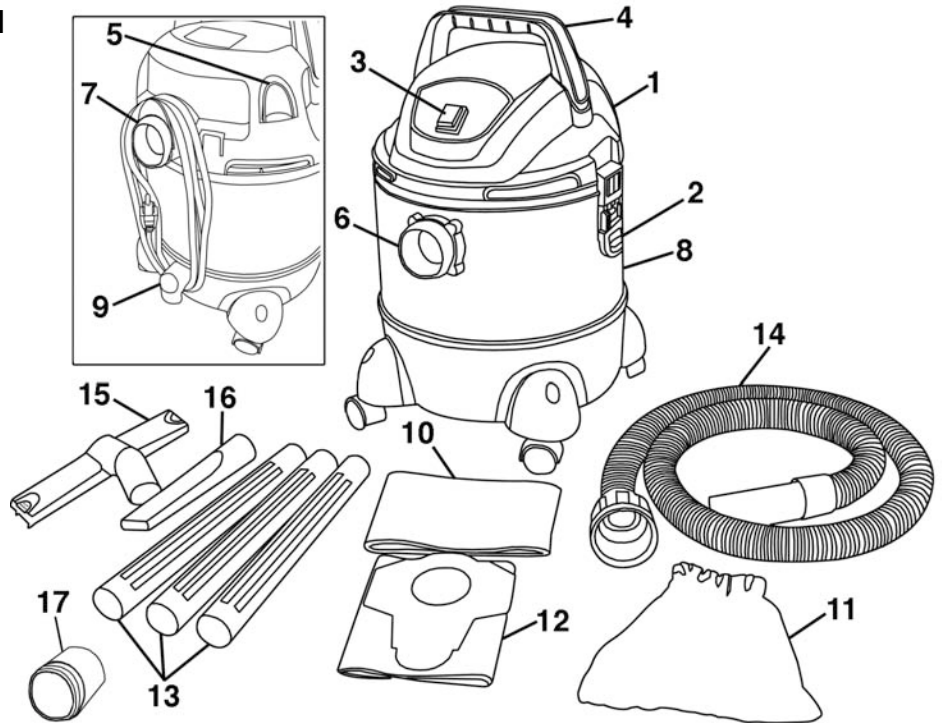

## ELECTRICAL INFO & SPECIFICATIONS

**POWER SUPPLY- WARNING:** YOUR VACUUM MUST BE CONNECTED TO A 110V, MINIMUM 15-AMP. BRANCH CIRCUIT. FAILURE TO CONNECT IN THIS WAY CAN RESULT IN INJURY FROM SHOCK OR FIRE.

**GROUNDING-** Your vacuum must be properly grounded. Not all outlets are properly grounded. If you are not sure if your outlet is properly grounded, have it checked by a qualified electrician. **WARNING:** IF NOT PROPERLY GROUNDED, THIS VACUUM CAN CAUSE ELECTRICAL SHOCK, PARTICULARLY WHEN USED IN DAMP LOCATIONS. TO AVOID SHOCK OR FIRE, IF THE POWER CORD IS WORN OR DAMAGED IN ANY WAY, HAVE IT REPLACED IMMEDIATELY.

If this vacuum should malfunction or breakdown, grounding provides a path of least resistance for electric current, to reduce the risk of electric shock. This vacuum is equipped with a cord having an equipment grounding conductor and grounding plug. The plug must be plugged into an appropriate outlet that is properly installed and grounded in accordance with all local codes and ordinances.

**110V OPERATION-** As received from the factory, your vacuum is ready to run for 110V operation. This vacuum is intended for use on a circuit that has an outlet and a plug which looks like the one illustrated in Fig. 1.

**EXTENSION CORDS-** The use of any extension cord will cause some loss of power. Use the table in Fig.2 to determine the minimum wire size (A.W.G-American Wire Gauge) extension cord. Use only 3-wire extension cords which have 3-prong grounding type plugs and 3-hole receptacles which accept the tool's plug. For circuits that are further away from the electrical circuit box, the wire size must be increased proportionately in order to deliver ample voltage to the motor. Refer to Fig.2 for wire length and size.

### SPECIFICATIONS

Model.....	8520LP
Voltage.....	110V
Horsepower .....	3.5 HP (peak)
Amperage .....	8A
Phase .....	1
Hertz .....	60Hz
Tank size .....	5 Gallon (US)/20 liters
Air flow .....	130 CFM
Vacuum pressure (inches of water) .....	60.3"

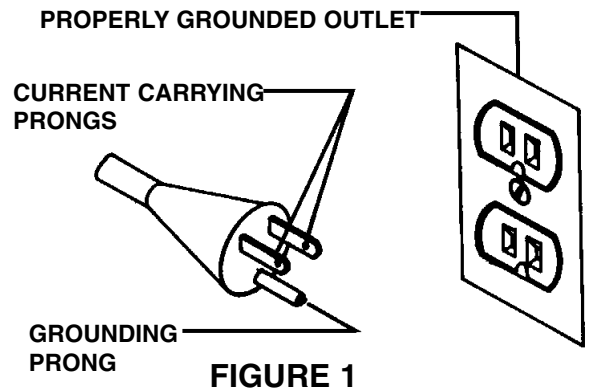

LENGTH OF CONDUCTOR	WIRE SIZES REQUIRED (AMERICAN WIRE GAUGE)
	<u>110V LINES</u>
0-25 FEET	NO.16
26-50 FEET	NO.16
51-100 FEET	NO.14

**FIGURE 2**



# UNPACKING & ASSEMBLING YOUR VACUUM

**ATTENTION!** The vacuum accessories are packed inside the vacuum tank.

## UNPACKING YOUR VACUUM

**Remove the entire contents of the carton**, please note that most of the accessories are packed inside the vacuum tank. To access these accessories, pull the cover latches (A) Fig.3 in an upward then downward motion, remove the tank cover/motor assembly and then remove the accessories inside the tank.

**WARNING!** DO NOT CONNECT THE POWER CORD TO THE POWER SOURCE UNTIL THE FOLLOWING ASSEMBLY AND SET-UP INSTRUCTIONS HAVE BEEN DONE.

## CASTER WHEEL ASSEMBLY

Four caster wheels are included and should be assembled to the bottom of the tank.

- 1) With the tank cover/motor assembly removed, turn the tank upside down. Insert the caster wheels (A) Fig.4 into the bottom of the tank as shown.
- 2) Make sure each caster wheel is pushed down all the way, then secure each caster wheel in place using the supplied screws and a screwdriver.

## TOP HANDLE ASSEMBLY

A top carry handle is included and should be assembled to the top of the cover/motor assembly.

- 1) Place the top handle into position on the cover, please note this handle only fits in one direction into the handle slots.
- 2) Make sure the handle (A) Fig.5 is pushed in all the way and secure it into place using the supplied screws and a screwdriver.

## INSTALLING THE CORRECT FILTER AND/OR DUST BAG FOR THE APPLICATION

Before reinstalling the cover/motor assembly on, it is important to determine the desired cleaning application, wet or dry vacuuming. Each cleaning application requires different filters and/or dust bag.

**When vacuuming dry materials**, to ensure proper filtration, the foam filter should be used when vacuuming coarse materials with low dust for maximum air flow. The re-usable filter can and should be used together with the foam filter when vacuuming coarse and dusty materials. Place the cover/motor assembly upside down, slide the foam filter (A) Fig.6 over the cage (B). Then slide the re-usable filter over the foam filter. Now the dust bag (C) must be installed to the inner portion of the inlet. Fit the dust bag flange over the inner inlet, taking care not to damage the dust bag.

**When vacuuming wet materials**, to ensure proper filtration, the foam filter must be installed. Place the cover/motor assembly upside down, slide the foam filter (A) Fig.6 over the cage (B).

Reposition and secure the cover/motor assembly to the tank with both cover latches.

## HOSE, WANDS AND ACCESSORY ASSEMBLY

- 1) Thread the nut end of the hose (A) Fig.7 to the vacuum inlet (front of the vacuum) and tighten the hose by turning clockwise, do not overtighten.
- 2) Assemble the 3 extension wands together and then attach one end of the extension wand assembly to the hose.
- 3) Attach either the floor sweep (B) Fig.7 or the crevice tool to the other end of the extension wand assembly (C).

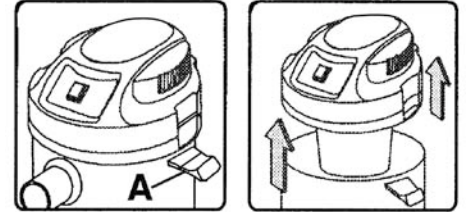

FIGURE 3

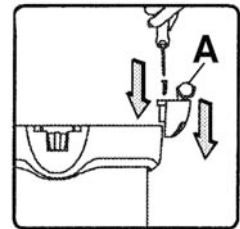
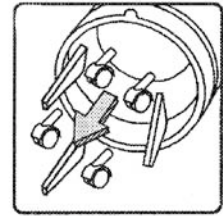

FIGURE 4

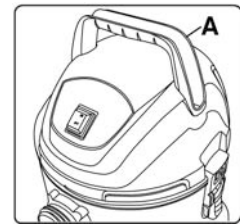

FIGURE 5

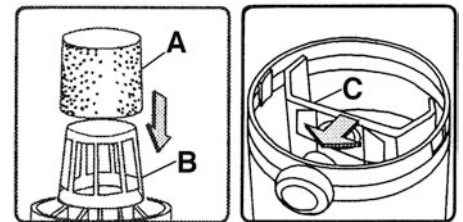

FIGURE 6

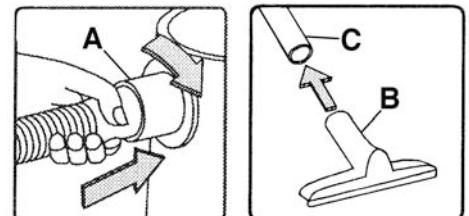

FIGURE 7

# OPERATION



## DRY VACUUMING OPERATIONAL STEPS

**Before vacuuming dry materials, it is important that you have read and understood the safety rules in this manual.**

- 1) Unplug the power cord from the power source.
- 2) Remove the cover/motor assembly by undoing the 2 side mounted cover latches and install a clean and dry foam filter. If the vacuuming operation is extremely dusty, install the re-usable filter over the foam filter. If it is necessary to vacuum dry materials and you have just finished vacuuming wet materials, the foam filter must be completely dried or else the foam filter will clog up quickly and it will be difficult to clean. The foam filter can be dried quickly by running the vacuum for 5-10 minutes without the hose installed.
- 3) Install the disposable dust bag on the inside of the tank to the inner portion of the inlet. Fit the dust bag flange over the inner inlet, taking care not to damage the dust bag.
- 4) Reposition and secure the cover/motor assembly to the tank using the 2 side mounted cover latches.
- 5) Attach the nut end of the hose to the inlet on the front of the vacuum and tighten the hose by turning clockwise, do not overtighten.
- 6) Assemble the 3 extension wands together and then attach one end of the extension wand assembly to the hose.
- 7) Attach either the floor sweep or the crevice tool to the other end of the extension wand.
- 8) Plug the power cord to a power source.
- 9) Start the vacuum by pushing the On/Off water proof switch to the On position as shown in Fig.9. The On position is indicated by the international symbol "I" on the switch.
- 10) Once the vacuuming operation is finished, push the switch to the Off position indicated by the international symbol "O" on the switch and unplug the power cord from the power source.
- 11) Remove the cover/motor assembly and lay it aside, being careful not to damage the filters and dump the tank contents into a suitable waste disposal container. **Airborn dust will be produced when cleaning, wear dust mask!**

### Warning!

Never use the disposable dust bag and re-usable filter for vacuuming wet materials. When vacuuming fine dust, it will be necessary to clean the foam filter and re-usable filter at more frequent intervals.

## WET VACUUMING OPERATIONAL STEPS

**Before vacuuming wet materials, it is important that you have read and understood the safety rules in this manual.**

- 1) Unplug the power cord from the power source.
- 2) Remove the cover/motor assembly by undoing the 2 side mounted cover latches and install a clean and dry foam filter. If wet vacuuming under normal conditions (small amounts of liquid pick-up), the foam and re-usable filters can be installed, but when vacuuming large amounts of liquid, only install the foam filter, see Fig.11. The dust bag can not be used for wet vacuuming. Make sure the inside of the tank is clean.
- 3) Reposition and secure the cover/motor assembly to the tank using the 2 side mounted cover latches.
- 4) Attach the nut end of the hose to the inlet on the front of the vacuum and tighten the hose by turning clockwise, do not overtighten.
- 5) Assemble the 3 extension wands together and then attach one end of the extension wand assembly to the hose.
- 6) Attach either the floor sweep or the crevice tool to the other end of the extension wand assembly. For wet applications, turn the brush/squeegee assembly around so the squeegee is facing outwards, this can be done by pressing the 2 snap points at each end of the floor sweep, the assembly will pop out, flip the assembly around and snap it back into place.
- 7) Plug the power cord to a power source.
- 8) Start the vacuum by pushing the On/Off waterproof switch to the On position as shown in Fig.12. The On position is indicated by the international symbol "I" on the switch.
- 9) When vacuuming large amounts of liquid, do not completely immerse the nozzle accessory in the liquid, leave a gap at the top of the nozzle accessory opening to allow air inflow.
- 10) Once the vacuuming operation is finished, push the switch to the Off position indicated by the international symbol "O" on the switch and unplug the power cord from the power source.

### Warning!

Never use the disposable dust bag and re-usable filter for vacuuming wet materials. The foam filter should be cleaned after each wet vacuuming operation. Should it become necessary to pick up the vacuum to move it, DO NOT pick up the vacuum by the top handle unless the tank is empty. Do not pull the vacuum by the hose, this may tip the vacuum over if the wheels are obstructed in any way.

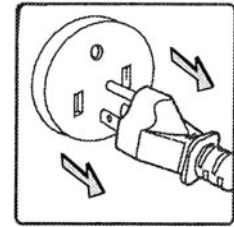

FIGURE 8

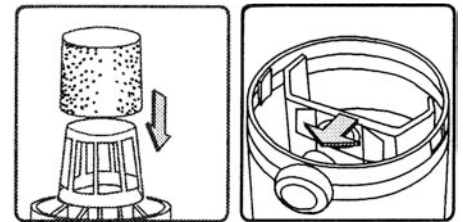

FIGURE 9

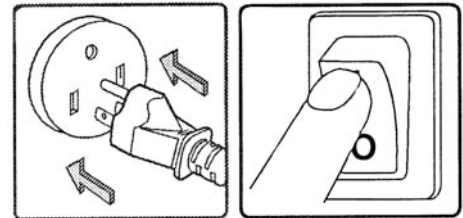

FIGURE 10

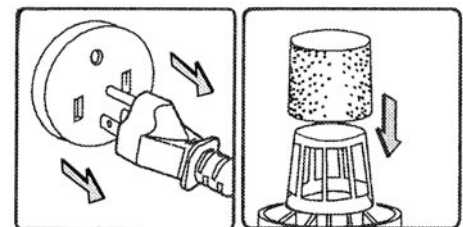

FIGURE 11

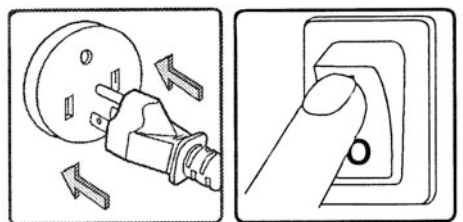

FIGURE 12



# OPERATION & MAINTENANCE

## AUTOMATIC SUCTION SHUT-OFF AND EMPTYING LIQUID FROM TANK

This section relates to wet vacuuming operations. This vacuum is fitted with an automatic suction shut-off float cup (A) Fig.14 which floats up when the liquid level increases in the tank, it then stops the suction action when the tank has reached its maximum capacity of liquid. Make sure the float cup is clean at all times.

**The user will notice an increased motor speed, when this happens;**

- 1) Turn off the vacuum immediately and unplug the power cord from the power source.
- 2) Remove the cover/motor assembly and lay it aside, being careful not to damage the filters and dump the tank contents into a suitable waste disposal container.
- 3) The inside of the tank should be cleaned, also check the foam filter and clean it from the inside out if necessary.
- 4) To continue vacuuming wet materials, reposition and secure the cover/motor assembly, plug the power cord to a power source and proceed.

## BLOWER FEATURE

This vacuum can be used as a powerful blower. To use the blower feature, disconnect the nut end of the hose and reconnect it to the rear blower adaptor, then insert the blower adaptor into the blower outlet as shown in Fig.15. Turn the vacuum On, your vacuum is now a blower to clear work tables of debris, blow leaves etc...

## STANDARD AND OPTIONAL ACCESSORIES

The following chart lists the standard accessories included and the available optional accessories for this wet•dry vacuum. Please note that these accessories are not covered under warranty and are available at your nearest King Canada distributor.

Model	Description	Usage	Included/Optional
KVAC-1001	20L Dust bags- 3pc. kit	Dry Vacuuming Applications	1pc. Included
KVAC-1040	Foam Filter- 1pc.	Wet•Dry Vacuuming Applications	1pc. Included
KVAC-1060	Re-usable Filter- 1pc.	Wet•Dry Vacuuming Applications	1pc. Included
KVAC-1070	Cartridge Filter- 1pc.	Dry Vacuuming Applications	Optional
KVAC-1080	8ft. x 1-1/4" Flex Hose- 1pc.	Hose with greater reach- extra 2ft	Optional
KVAC-1085	8ft. x 2-1/2" Flex hose-5pc. kit	(Hose, 2pc. wand, floor sweep and crevice tool)	Optional
KVAC-1101	1-1/4" Round Brush- 1pc.	Upholstery and car interiors	Optional
KVAC-1103	1-1/4" Gulper Tool- 1pc.	General purpose	Optional
KVAC-1105	1-1/4" Crevice Tool- 1pc.	General purpose	1pc. Included
KVAC-1107	10" x 1-1/4" Floor Sweep- 1pc.	General purpose-reversible attachment	1pc. Included
KVAC-1120	Caster Wheels- 4pc. kit	Replacement kit	4pcs. Included
KVAC-1130	High Efficiency Cartridge Filter	Drywall and fine dust applications	Optional
KVAC-1131	20L High Efficiency Dust bags- 3pc. kit	Drywall and fine dust applications	Optional

## ON-BOARD ACCESSORY STORAGE

When the 10" floor sweep or crevice tool is not in use, it can be stored in the on-board storage as shown in Fig.16.

## MAINTAINING YOUR VACUUM AND ACCESSORIES

**Warning! To reduce the risk of injury and electrical shock, unplug the power cord from the power source. Airborn dust will be produced when cleaning, wear dust mask!**

To maintain peak vacuum performance, the foam and re-usable filters must be cleaned often. When not in use, wrap the power cord around the power cord posts as shown in Fig.17.

**Filter maintenance-** Clean the foam filter and re-usable filter by washing them inside out in a mild soapy water and then rinse with clean water. Allow these filters to dry completely before using.

**General Maintenance and Inspection-** The inside of the tank, hose, extension wands and accessories should be cleaned after every use, this cleaning should only be done outdoors with the power cord disconnected from the power source. Check the condition of the power cord and make sure it is not damaged. Also check the condition of the filters for tears and small holes. Do not use filters with tears or small holes, replace with new filters.

## TROUBLESHOOTING

**Dust comes from the motor cover-**

Place/replace the dust bag if dust bag is missing or damaged.

**Reduced efficiency/increased motor speed-**

Inlet is block or tank is full- Unblock inlet or empty tank.

## PARTS DIAGRAM & PARTS LISTS

Refer to the Parts section of the King Canada web site for the most updated parts diagram and parts list.

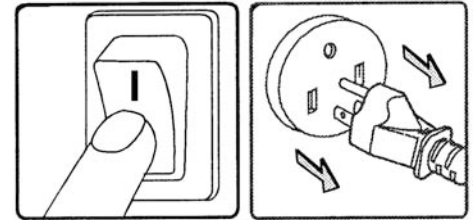

FIGURE 13

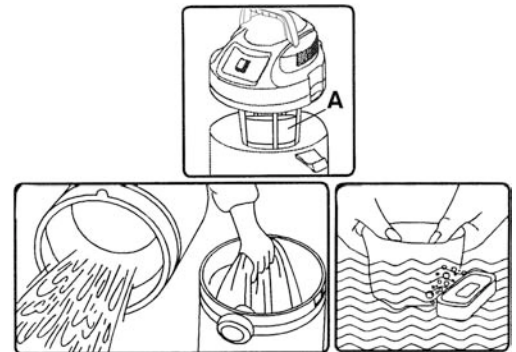

FIGURE 14

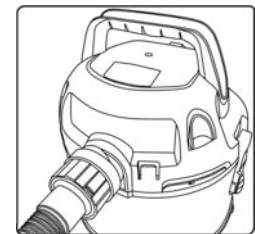

FIGURE 15

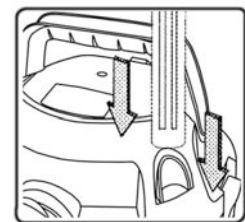

FIGURE 16

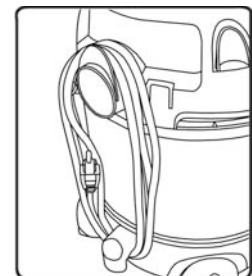

FIGURE 17