

## Owner's Manual

Model No.  
16005906800

- Assembly
- Operation
- Adjustments
- Parts
- Warranty

### **CAUTION:**

*You must read and understand this owner's manual before operating unit.*

*Keep this manual for future reference.*

*Serial number*

---

*Write the serial number in the space above for reference. Serial number can be found at the front bottom section of the Treadmill.*

# EVERLAST®



**PLEASE CAREFULLY READ THIS ENTIRE MANUAL BEFORE OPERATING YOUR NEW TREADMILL!**

# TABLE OF CONTENTS

Important Safety Instructions .....	3
Important Electrical Instructions .....	5
Assembly Instructions .....	6
Operation of Your Treadmill .....	11
Parts Diagram and List .....	23
General Maintenance .....	27
Service Checklist .....	31
Troubleshooting .....	32
Training Guidelines .....	33
Manufacturer's Limited Warranty .....	39

## **ATTENTION**

THIS TREADMILL IS INTENDED FOR **RESIDENTIAL USE ONLY** AND IS WARRANTED FOR THE APPLICATION. ANY OTHER APPLICATION **VOIDS** THIS WARRANTY IN ITS ENTIRETY.

## BEFORE YOU BEGIN

Thank you for choosing the Everlast EV680 Treadmill. We take great pride in producing this quality product and hope it will provide many hours of quality exercise to make you feel better, look better, and enjoy life to its fullest. It's a proven fact that a regular exercise program can improve your physical and mental health. Too often, our busy lifestyles limit our time and opportunity to exercise. The Everlast EV680 Treadmill provides a convenient and simple method to begin your assault on getting your body in shape and achieving a happier and healthier lifestyle. Before reading further, please review the drawing below and familiarize yourself with the parts that are labeled.

Read this manual carefully before using the Everlast EV680 Treadmill. Although Dyaco Canada Inc. constructs its products with the finest materials and uses the highest standards of manufacturing and quality control, there can sometimes be missing parts or incorrectly sized parts. If you have any questions or problems with the parts included with your Everlast EV680 Treadmill, please do not return the product. Contact us **FIRST!** If a part is missing or defective call us toll free at 1-888-707-1880. Our Customer Service Staff are available to assist you from 8:30 A.M. to 5:00 P.M. (Eastern Time) Monday through Friday. Be sure to have the name and model number of the product available when you contact us.



MAX. USER WEIGHT LIMIT 159 KGS (350 LBS)

# IMPORTANT SAFETY INSTRUCTIONS

THIS UNIT IS INTENDED FOR HOUSEHOLD USE ONLY  
READ ALL INSTRUCTIONS BEFORE USING THIS TREADMILL

**CAUTION:** Before starting any exercise program, it is recommended that you consult your physician.

**WARNING:** Connect this unit to a properly grounded outlet only.

**DANGER:** To reduce the risk of electric shock, always unplug the treadmill from the electrical outlet immediately after using and before cleaning.

**WARNING**

To reduce the risk of burns, fire, electric shock, or injury to persons:

## Grounding Instructions

This product must be grounded. If it should malfunction or breakdown, grounding provides a path of least resistance for electric current to reduce the risk of electric shock. This product is equipped with a cord having an equipment-grounding conductor and a grounding plug. The plug must be plugged into an appropriate outlet that is properly installed and grounded in accordance with all local codes and ordinances. See diagram below for grounding methods.

Figure 1.

Grounding methods

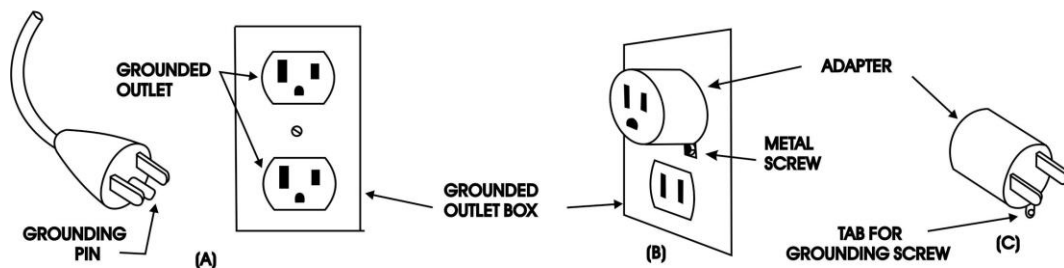

AA 200

1. Use 120-volt a.c. household current on a dedicated circuit.
2. It is the responsibility of the owner to ensure that all users of this treadmill are adequately informed of all warnings and precautions.
3. The use of an extension cord with this product is not recommended. If an extension cord is needed, use a short (less than 10 feet) heavy gauge (14 gauge or better) extension cord with a three prong (grounded) plug and receptacle.
4. Never leave the treadmill unattended when plugged in. Remove the safety key and unplug the unit from the outlet when not in use and before removing or replacing parts.
5. Never operate the treadmill if it has a damaged cord or plug, if it is not working properly, if it has been dropped, damaged, or exposed to water. Never move the treadmill belt while the power is turned off.
6. Do not pull the treadmill by the power supply cord or use cord as a handle. Keep cord away from heated surfaces and open flames.
7. Fitness equipment must always be installed and used on a flat surface. Do not use outdoors or near water. Do not place the unit on a loose rug or uneven surface. It is recommended to use an equipment mat to prevent the unit from moving while it is being used, which could possibly scratch or damage the surface of your floor. It is recommended to have a minimum of 3 metres safe clearance on all sides of the treadmill while in use.
8. Keep the treadmill indoors, away from moisture and dust. Do not put the treadmill in a garage, covered patio or near water.

9. Do not operate the treadmill where aerosol products are used or where oxygen is being administered.
10. Read, understand, and test the emergency stop procedure before using the treadmill. Do not insert any objects into any openings.
11. Inspect and properly tighten all parts of the treadmill regularly.
12. Keep children and pets away from this equipment at all times while exercising.
13. Handicapped individuals should have medical approval and close supervision when using this treadmill.
14. Do not place hands or feet under the treadmill. Always keep hands and legs off of the treadmill when others are using it.
15. Never turn on treadmill while standing on tread-belt. Always hold the handrails while using the treadmill. Always return the treadmill to the slowest speed to provide for safe dismount and low speed restart.
16. To disconnect, turn all controls to the off position, then remove plug from outlet.
17. Do not attempt to raise, lower or move the treadmill until it is properly assembled. See assembly on page 8 and to fold and move the treadmill on page 10. Care must be taken when lifting or moving the equipment, so as not to injure your back. Always use proper lifting techniques. You must use any attachments that are not recommended by the manufacturer.
18. Use the treadmill only for its intended use as described in this manual. Do not use any attachments that are not recommended by the manufacturer.
19. User weight should not exceed 350lbs (159 kg).
20. Never allow more than one person on the treadmill at once.
21. Warm up 5 to 10 minutes before each workout and cool down 5 to 10 minutes afterward. This allows your heart rate to gradually increase and decrease and will help prevent straining muscles.
22. Never hold your breath while exercising. Breathing should remain at a normal rate in conjunction with the level of exercise being performed. If dizziness, nausea, chest pains, or any other abnormal symptoms are experienced while using this equipment, STOP the workout at once. CONSULT A PHYSICIAN IMMEDIATELY.
23. Start your program slowly and very gradually increase your speed and distance.
24. Always wear suitable clothing and footwear while exercising. Do not wear loose fitting clothing that could become entangled with the moving parts of your treadmill. Do not walk or jog barefoot, in stocking feet or loose-fitting shoes or slippers.
25. This treadmill is intended for in-home use only. Do not use the treadmill in any commercial, rental or institutional setting.
26. This exercise equipment is not intended for use by persons with reduced physical, sensory or mental capabilities, or lack of experience and knowledge.
27. Close supervision is necessary when this appliance is used by, on, or near children, invalids, or disabled persons.



**WARNING:** Before beginning any exercise program consult your physician. This is especially important for individuals over the age of 35 or persons with preexisting health problems. Read all instructions before using any fitness equipment. We assume no responsibility from personal injury or property damage sustained by or through the use of this product.

**SAVE THESE INSTRUCTIONS - THINK SAFETY!**

# IMPORTANT ELECTRICAL INSTRUCTIONS

## **WARNING!**

- **NEVER** use a ground fault circuit interrupt (GFCI) wall outlet with this treadmill. Route the power cord away from any moving part of the treadmill including the elevation mechanism and transport wheels.
- **NEVER** remove any cover without first disconnecting AC power.
- If voltage varies by ten percent (10%) or more, the performance of your treadmill may be affected. **Such conditions are not covered under your warranty.** If you suspect the voltage is low, contact your local power company or a licensed electrician for proper testing. See Diagnosis Guide, page 28.
- **NEVER** expose this treadmill to rain or moisture. This product is **NOT** designed for use outdoors, near a pool or spa, or in any other high humidity environment.

**This product must be grounded.** If the treadmill should malfunction or breakdown, grounding provides a path of least resistance for electric current, reducing the risk of electric shock. This product is equipped with a cord having an equipment-grounding plug. The plug must be plugged into an appropriate outlet that is properly installed and grounded in accordance with all local codes and ordinances.



**DANGER - Improper connection of the equipment-grounding conductor can result in a risk of electric shock. Check with a qualified electrician or serviceman if you are in doubt as to whether the product is properly grounded. Do not modify the plug provided with the product if it will not fit the outlet; have a proper outlet installed by a qualified electrician.**

- **NEVER** operate this treadmill without reading and completely understanding the results of any operational change you request from the computer.
- Understand that changes in speed and incline do not occur immediately. Set your desired work level on the computer console and release the adjustment key. The computer will obey the command gradually.
- **NEVER** use your treadmill during an electrical storm. Surges may occur in your household power supply that could damage treadmill components.
- Use caution while participating in other activities while walking on your treadmill, such as watching television, reading, etc. These distractions may cause you to lose balance or stray from walking in the center of the belt; which may result in serious injury.
- **NEVER** mount or dismount the treadmill while the belt is moving. Our treadmills start with at a very low speed and it is unnecessary to straddle the belt during start up. Simply standing on the belt during slow acceleration is proper after you have learned to operate the unit.
- Always hold on to a handrail or hand bar while making control changes (incline, speed, etc.).

Do not use excessive pressure on console control keys. They are precision set to function properly with little finger pressure. Pushing harder is not going to make the unit go faster or slower. If you feel the buttons are not functioning properly with normal pressure, contact your dealer.

# ASSEMBLY INSTRUCTIONS

**!!ATTENTION: IMPORTANT UNPACKING INSTRUCTIONS.  
PLEASE READ BEFORE UNPACKING YOUR FOLDING TREADMILL!!**

Serious injury could occur if this folding treadmill is not unpacked properly.

There is a Velcro strap installed around the treadmill base that prevents the treadmill from unfolding accidentally during shipping. If this strap is not removed properly the treadmill could spring open unexpectedly and cause injury if someone is standing near the treadmill when the strap is removed.

To ensure your personal safety during removal of the shipping strap please make sure the treadmill is positioned flat on the ground, in the orientation it would be in if you were using the treadmill. Do not turn the treadmill up on its side while removing the shipping strap. This could cause the treadmill's folding mechanism to spring open. If the end of the Velcro strap (that you need to grab to remove it) happens to be under the treadmill deck, reach under the deck to grab it, but do not tilt the treadmill up to gain access to the strap end.

Unpack the treadmill and locate the hardware pack.

**WARNING / AVERTISSEMENT**

EVERLAST  
Model/Modèle#: 16005906800 (PR:0919)  
Serial#/Numéro de série:

**For consumer use**  
Max user weight limit  
350 lbs. (159kgs)  
CAUTION: SMALL CHILDREN  
AND PERSONS PHYSICALLY  
HANDICAPPED SHOULD NOT  
USE ANY EXERCISE  
EQUIPMENT WITHOUT A  
QUALIFIED PERSON IN  
ATTENDANCE.  
WARNING: KEEP CHILDREN  
AWAY FROM THE TREADMILL.  
KEEP BODY AND CLOTHING FREE  
AND CLEAR OF ALL MOVING PARTS.  
THE POSSIBILITY OF  
SERIOUS INJURIES OR DEATH IF  
CAUTION IS NOT USED.  
READ ALL WARNINGS AND  
INSTRUCTIONS PRIOR TO USE.  
REPLACE LABEL IF DAMAGED,  
ILLEGIBLE OR REMOVED.  
MADE IN CHINA

**Usage à des fins  
personnelles**  
poids maximum de l'utilisateur  
350 lbs (159kgs)  
ATTENTION:  
LES ENFANTS  
ET LES PERSONNES AVANT  
UN HANDICAP PHYSIQUE  
NE DOIVENT UTILISER  
AUCUN APPAREIL D'EXERCICE  
SANS LA SURVEILLANCE D'UNE  
PERSONNE QUALIFIÉE.  
AVERTISSEMENT:  
GARDER LES ENFANTS À L'ÉCART DU  
TAPIS ROULANT  
GARDER LE CORPS ET LES VÊTEMENTS  
ÉLOIGNÉS DE TOUTE PIÈCE MOBILE.  
LE DÉFAUT DE VIGILANCE DANS L'UTILISATION  
DE CET APPAREIL POURRAIT ENTRAINER  
DE GRAVES BLESSURES ET MÊME LA MORT.  
LIRE TOUTS LES AVERTISSEMENTS ET TOUTES  
LES DIRECTIVES AVANT UTILISATION.  
REPLACER TOUTE ÉTIQUETTE  
ENDOMMAGÉE, ILLISIBLE  
OU MANQUANTE.  
FABRIQUÉ EN CHINE

Dyaco Canada Inc.  
5955 Don Murie St  
Niagara Falls, Ontario  
L2G 0A9  
Customer Service  
Service à la clientèle  
1-888-707-1880

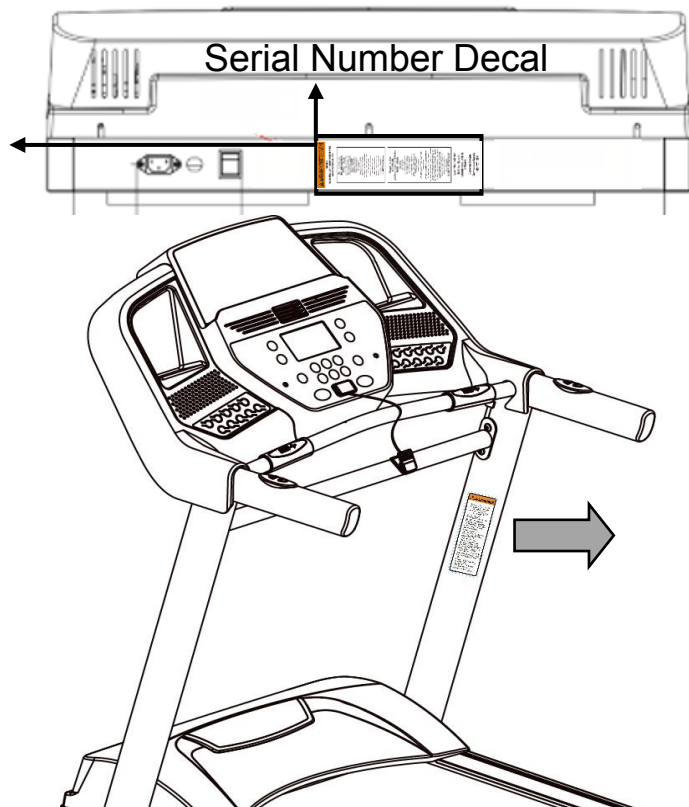

**WARNING**

Failure to follow these guidelines could result in serious injury or death:

- Consult your physician before use
- Stop immediately if you become dizzy or experience chest pains and consult your physician
- Heart Rate monitoring systems can be inaccurate; use them for reference only
- Read all warnings on the unit and be properly instructed or read the Owner's manual on how to use before beginning
- Inspect this machine for damage prior to use
- Keep body, clothing, and fitness accessories clear of moving parts
- Keep children away

The decals shown have been placed on the treadmill. If a decal is missing or illegible, please call our Customer Service Department, to order a free replacement decal (see ORDERING REPLACEMENT PARTS at page 2.). Apply the decal in the location shown. Note: The decal shown at the right is 50% of actual size.

# HARDWARE PACKING

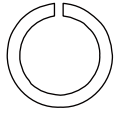

**#80.** Ø8 × 1.5m/m  
Split Washer (4pcs)

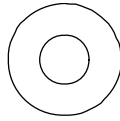

**#100.** Ø8 × Ø18 × 1.5m/m  
Flat Washer (8pcs)

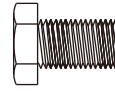

**#99.** 5/16" × UNC18 × 1/2"  
Hex Head Bolt (8pcs)

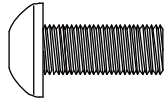

**#125.** 5/16" × UNC18 × 3/4"  
Button Head Socket Bolt (8pcs)

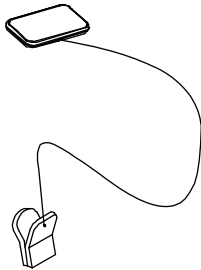

**#44.** Safety Key (1pc)

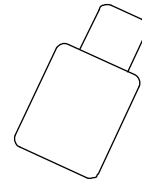

**#104.** Lubricant (1pc)

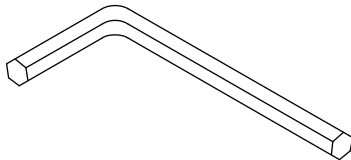

**#103.** M6 (66 × 86)  
L Allen Wrench (1pc)

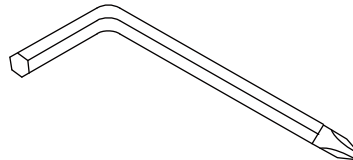

**#102.** Combination M5 Allen Wrench  
& Phillips Head Screwdriver (1pc)

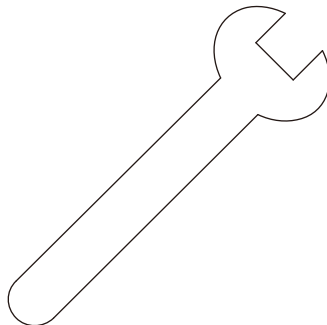

**#90.** 13L Wrench (1pc)



# ASSEMBLY INSTRUCTIONS

## Step 1.

Remove the treadmill from the carton and lay it on a smooth level surface.

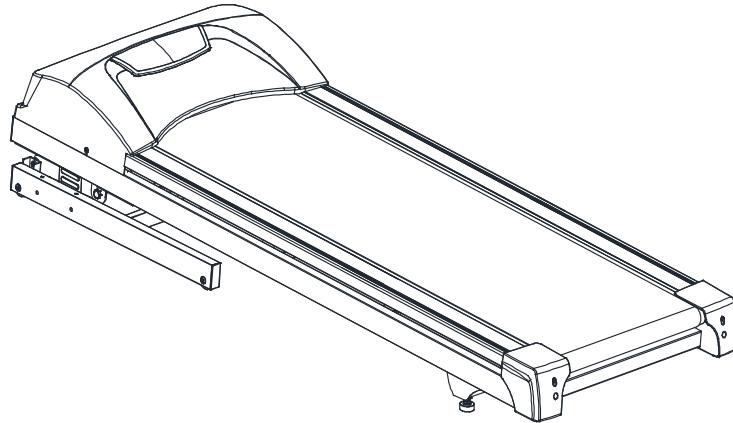

## Step2.

Connect Computer Cable (Middle) (54) with Computer Cable (Lower) (55) then insert Right and Left Uprights (4) and (5) into the Frame Base (2) and use 13m/m Wrench (90) to tighten 8 pcs of 5/16" × UNC18 × 1/2" Hex Head Bolts (99) and 8pcs of Ø8 × Ø18 × 1.5T Flat Washers (100). Tip: Avoid pinching wires.

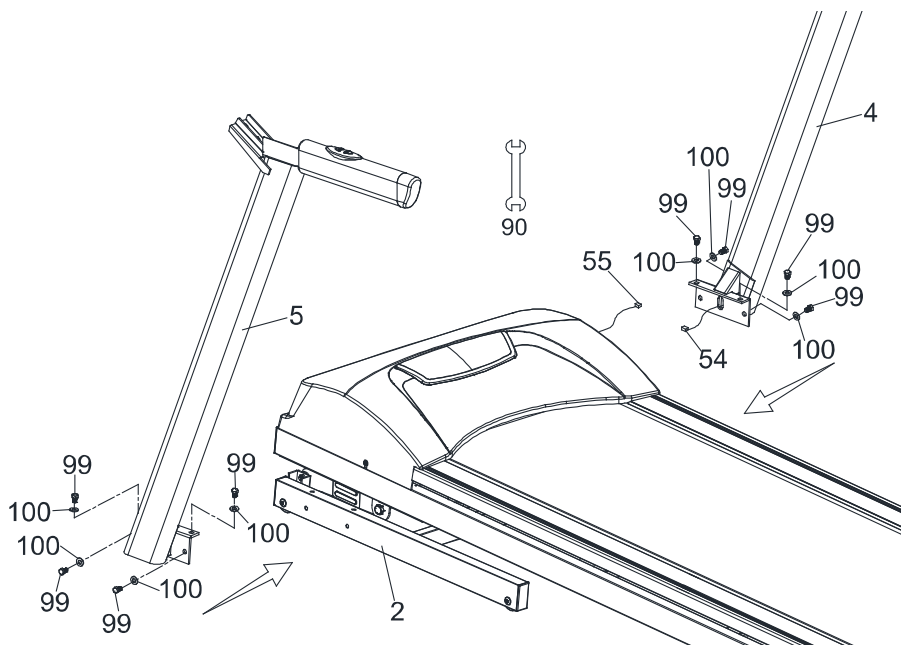

### Step 3

1. Connect the Computer Cable (Middle) (54) to the Computer Cable (Upper) (53).
2. Connect the Speed Adjustment Switch W/Cable (Upper) (114) to the Speed/Hand Pulse Complex (28).
3. Connect the Incline Adjustment Switch W/Cable (Upper) (115) to the Incline/Hand Pulse Complex (29).
4. Insert the Console Assembly (21) into the right and left Uprights (4) and (5) and secure with 4 pcs of 5/16" × UNC18 × 3/4" Button Head Socket Bolts (125) with 4 pcs of Ø8 × 1.5T Split Washers (80) by using the Combination M5 Allen Wrench & Phillips Head Screwdriver (102). Tip: Avoid pinching wires.

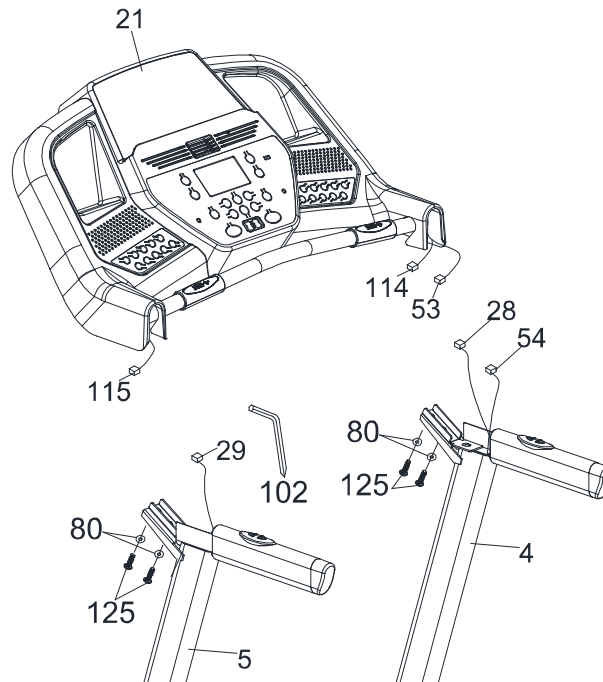

### Step 4.

Install the Handrail Support (9) between the left and right Uprights (5) and (4) and use the Combination M5 Allen Wrench & Phillips Head Screwdriver (102) to tighten 4 pcs of 5/16" × UNC18 × 3/4" Button Head Socket Bolts (125).

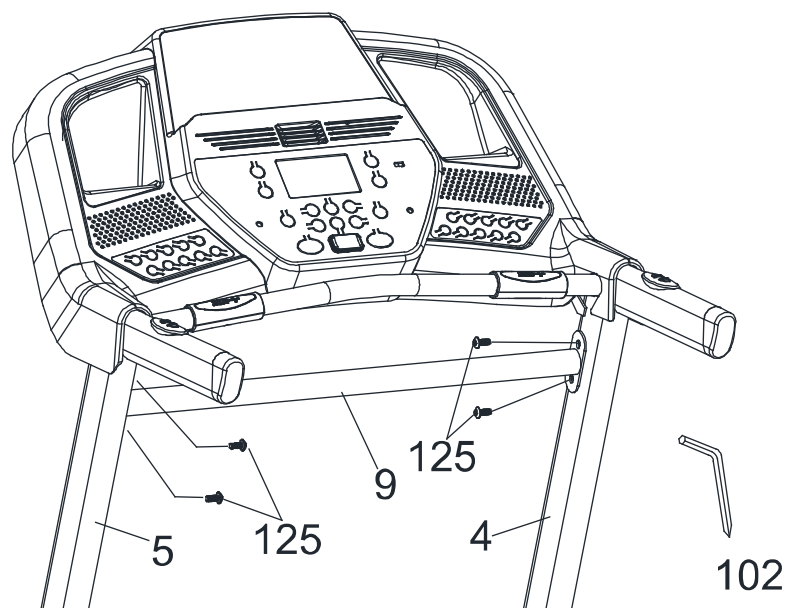

Your unit is now fully assembled. Ensure all nuts and bolts are firmly tightened prior to use.

# FOLDING INSTRUCTIONS

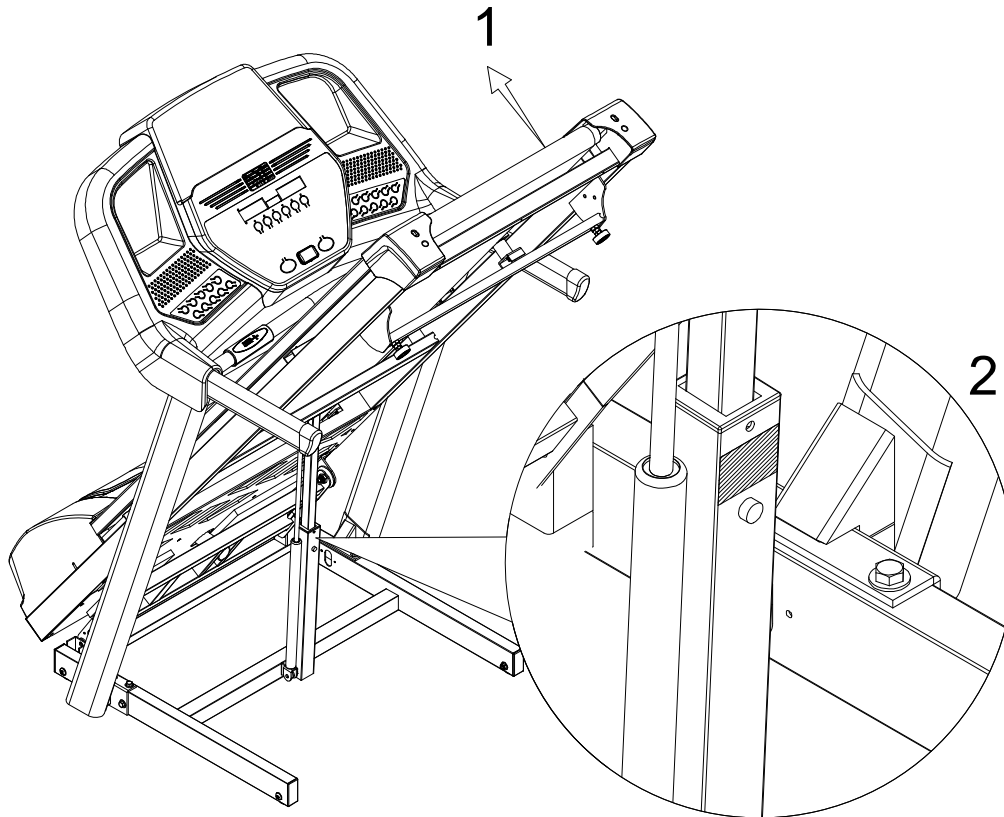

Do not attempt to move the unit unless it is in the folded and locked position. Be sure the power cord is secured to avoid possible damage. Use both handrails to maneuver the unit to the desired position.

## ■ TO FOLD THE TREADMILL

Lift the deck until the latch clicks in place.

## ■ TO UNFOLD THE TREADMILL

Press the tube with your foot at the yellow sticker  
To release latch, see picture to the right.

## Transportation

The treadmill is equipped with four transportation wheels. After folding simply roll the treadmill away.

# TREADMILL OPERATION

Your treadmill features a walking belt coated with a lubricant. **IMPORTANT:** Never apply silicone spray or other substances to the walking belt or walking board. Such substances will deteriorate the walking belt and cause excessive wear.

## How to plug in the power cord.

### GROUNDING INSTRUCTIONS.

This product must be grounded.

### **WARNING:**

Improper connection of the equipment grounding conductor can result in a risk of an electric shock. Check with a qualified electrician if you are in doubt as to whether the product is properly grounded. Do not modify the plug provided with the product, if it will not fit the outlet; have a proper outlet installed by a qualified electrician. The use of an extension cord with this product is not recommended. If an extension cord is needed, use a short (less than 10 feet) heavy gauge (14 gauge or better) extension cord with a three prong (grounded) plug and receptacle. **IMPORTANT:** If the power cord is damaged, it must be replaced with a manufacturer recommended power cord.

1. Plug the indicated end of the power cord into the socket of the treadmill. See drawing on the right.

2. Plug the power cord into an appropriate outlet that is properly installed and grounded. See drawing on the right. Important: The treadmill is not compatible with GFCI-equipped outlets.

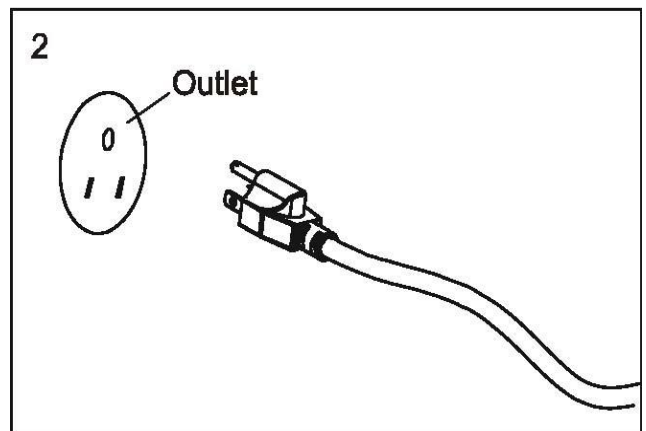
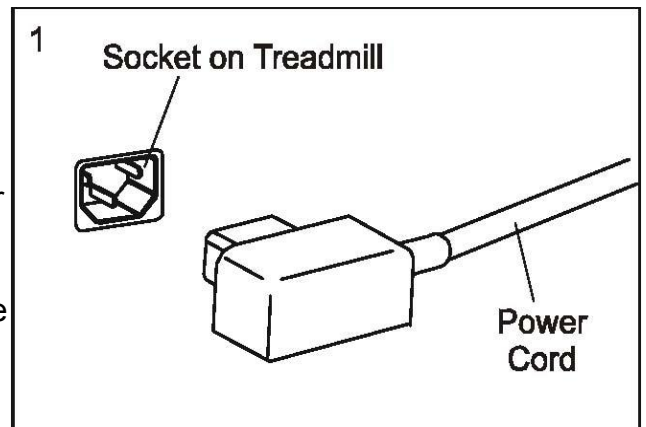

Note: Your power cord and outlet may appear different.

# OPERATION OF YOUR TREADMILL



## GETTING STARTED:



**CAUTION:** Before operating the console, read the following precautions:

Do not stand on the walking belt when turning on the treadmill

Always wear the safety key. Pulling the safety key will stop tread-belt movement.

Adjust the speed in small increments to avoid sudden jumps in speed

To reduce the possibility of electric shock, keep the console dry. Avoid spilling liquids on the console and place only sealed water bottles in the water bottle holders.

Do not use excessive pressure on console control keys. They are precision set to

function properly with little finger pressure. Pushing harder is not going to make the unit go faster or slower.

Understand that changes in speed and incline do not occur immediately. Set your desired speed on the computer console and release the adjustment key. The computer will obey the command gradually.

## LUBE MESSAGE

When "Lube" appears on the LCD check lubrication under walking deck.  
(Use a total of 90 hours.)

After application hold PROGRAM for 3 seconds to reset the message.

## TO OPERATE TREADMILL



**CAUTION:** To avoid injury, hold onto the handrails while mounting and dismounting the treadmill. Hold onto the handrails and place feet on side rails before starting. Step onto the walking belt only at a slowest speed. Always hold on to a handrail or hand bar while making control changes (incline, speed, etc.). Before operating the console make sure that the power cord is properly plugged in and the on / off button is on. Attach the magnet end of the safety key onto the monitor and attach the clip end of the safety key to your clothing (ie: waistband). If you should slip or fall while exercising the safety key will pull out of the console, shutting off the treadmill.

### Getting started:

Power the treadmill on by plugging it into an appropriate wall outlet, then turn on the power switch located at the front of the treadmill below the motor hood.

## WINDOW DISPLAY

- Speed:** Displays the current speed from starting at 0.5 mph to 12.0 mph.
- Time:** Displays your elapsed workout time in minutes up to 99:59.  
Counts down from your preset target time to 00:00 during your workout.
- Distance:** Displays the distance traveled in miles.
- Calories:** Displays the cumulative calories burned at any given time during your workout.  
**Note:** This is a rough guide used for comparison of different exercise sessions, which cannot be used for medical purposes.
- Pulse:** Displays the user's current heart rate in beats per minutes during the workout.  
To display your heart rate, you must hold both handrails.  
**Note:** This is a rough guide used for comparison of different exercise sessions, which cannot be used for medical purposes.
- Incline:** Displays the incline level during your workout from 0 to 12.
- Program:** Displays the program selected, between Manual, P1-P24, Fatburn-P9, Cardio-P12, Strength-P17, HIIT-P22, HR1, HR2, User1 or User2
- Fan:** The fan is used to cool you down during your workout.
- Audio System:** There is an Audio Input Jack on the front of the console, and built-in speakers. You may plug any low-level audio source signal into this port. Audio sources include: MP3 player, iPod, portable radio, CD player or even a TV or computer.

The exercise equipment is configured with Bluetooth wireless music receive function, using a mobile phone or tablet to open the Bluetooth device, search for the name "BT-Speaker" Bluetooth, click on the connection can transmit the phone or tablet music to the exercise equipment.

## BUTTON FUNCTION

**SPEED ▲ (FAST)** : Pressing this button increases the speed by 0.1 mph. Press and hold this button for 3 seconds to increase speed rapidly. Press this button during setting the program to adjust the value (to increase).

**SPEED ▼ (SLOW)** : Pressing this button decreases the speed by 0.1 mph. Press and hold this button for 3 seconds to decrease speed rapidly. Press this button during setting the program to adjust the value (to decrease).

**INCLINE ▲ (UP)** : Pressing this button increases the incline level by 1. Press and hold this button for 3 seconds to increase the incline level rapidly. Press this button during setting the program to adjust the value (to increase).

**INCLINE ▼ (DOWN)** : Pressing this button decreases the incline level by 1. Press and hold this button for 3 seconds to decrease the incline level rapidly. Press this button during setting the program to adjust the value (to decrease).

**ENTER:** Press this button to set Time, Distance, Calorie and other functions for program setting.

**PROGRAM:** Press to select one of the pre-set programs: MANUAL, P1-P24, FATBURN- P9, CARDIO- P12, STRENGTH- P17, HIIT- P22, USER1-USER2 or HR1-HR2

**START:** Press this button to start treadmill at 0.5 mph start speed.

**STOP:** Press key once during training mode and treadmill will enter pause mode, slowing down to a complete stop. Incline will also return to starting position while in pause mode. Press start key again to resume training, resuming all set values (speed and incline) prior to entering pause mode.

**FAN:** Press this button to turn on fan.

## QUICK SPEED & INCLINE BUTTONS

**Speed shortcut key 1-10** : Press one of the buttons to set the speed rapidly.

**Incline shortcut key 1-10:** Press one of the buttons to set the incline rapidly

# Treadmill Operation

## QUICK START:

After the treadmill is powered on and the safety key is in place simply press the START key. The treadmill will start at the minimum speed of 0.5 mph, the time will count up from zero and all data will begin to accrue. You can adjust the speed manually by pressing the Fast and Slow buttons and you can adjust the Incline with the Up and Down buttons.

## PROGRAMS

**STEP 1:** Press Program button to scroll through from Manual pre-set programs. Press Enter to select the program you desire.

**STEP 2:** Preset time for programs is 30 minutes. Press the SPEED ▲ / ▼ button to modify the time value.

**STEP 3** Press START button to begin your workout.

**STEP 4:** During the program, you can adjust the SPEED and INCLINE by pressing "SPEED ▲ / ▼ button and INCLINE ▲/ ▼ button or use rapid keys to jump directly to a setting.

**STEP 5:** Press "STOP" button to stop your workout or pull safety key away from its position to shut down the computer.

## USER PROGRAMS

**STEP 1:** Press Program button to scroll to USER 1 or USER 2 press Enter.

**STEP 2:** Use the SPEED ▲ / ▼ button to adjust the time up from 30 minutes (if desired). Press the **Enter** key.

**STEP 3:** Press the SPEED ▲ / button to adjust the speed level to your desired effort and press the INCLINE ▲/ ▼ button to adjust the incline level to your desired effort then press Enter. Repeat the above process until all 20 segments have been programmed.

**STEP 4:** Press the **Start** button to begin the workout

## TARGET HRC1 HRC2

**STEP 1:** Press Program button to scroll to HR1 (preset value  $(220-\text{age}) \times 60\%$ ) and HR2. (preset value  $(220-\text{age}) \times 80\%$ ), press Enter

HRC1 adjust the speed to keep the heart rate at the target value

HRC2 adjust the incline to keep the heart rate at the target value

**STEP 2:** Press SPEED ▲ / ▼ button to adjust the age and press enter.

**STEP 3:** Press SPEED ▲ / ▼ button to adjust target Heart Rate, then press ENTER button to proceed to the next step.

**STEP 4:** The preset value of time is 30:00, and the range is from 5:00 to 99:00. Press SPEED ▲ / ▼ button to modify.

**STEP 5:** Press START to execute your program.

**STEP 6:** Press "STOP" button to stop your workout or pull safety key away from its position to shut down the computer.

**Note:** Handpulse sensor to be used. If no heart rate detected the program will stop.

When heart rate is lower than target, incline or speed will increase to increase level of workout raising heart rate. When heart rate reaches target, no changes will be made. When heart rate is higher than target, incline or speed will decrease to lower heart rate.



# PRESET PROGRAMS

The treadmill has 24 different programs that have been designed for a variety of workouts. These 24 programs have factory preset work level profiles for achieving different goals.

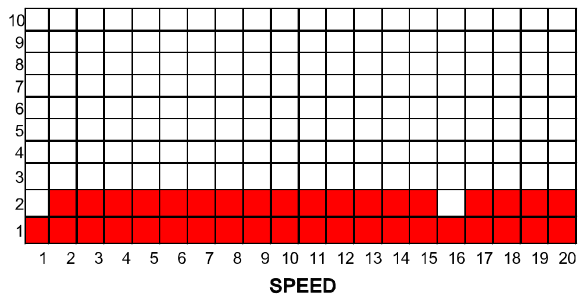

P1

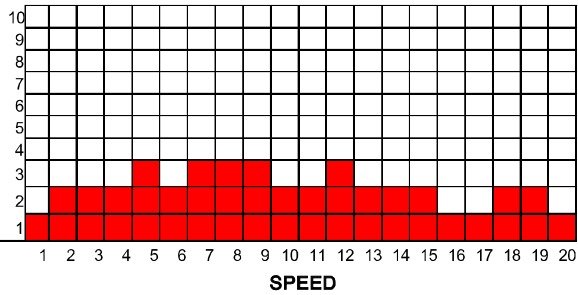
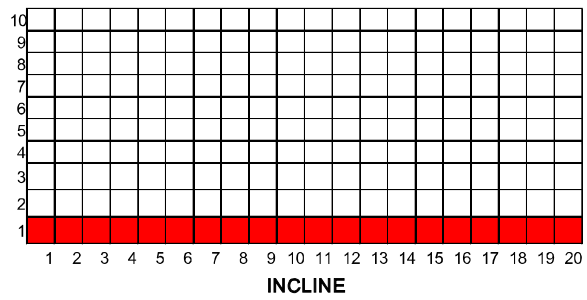

P2

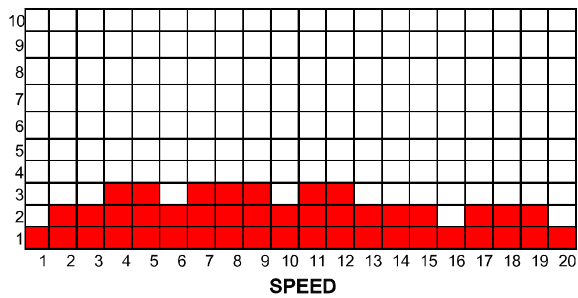
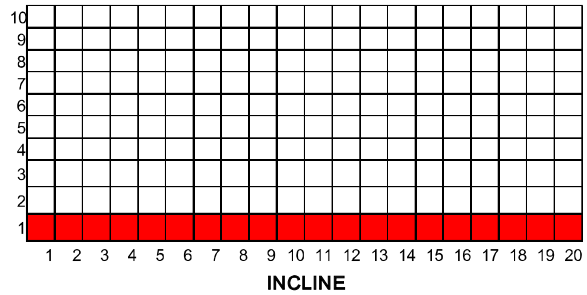

P3

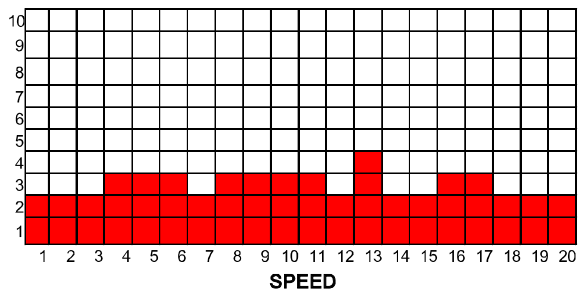
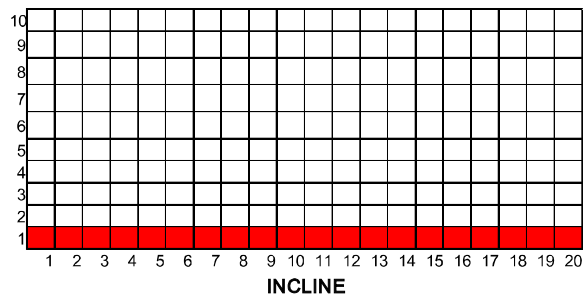

P4

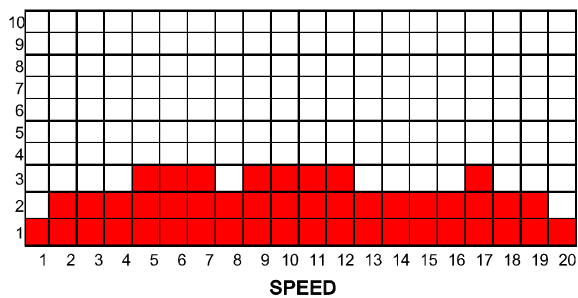
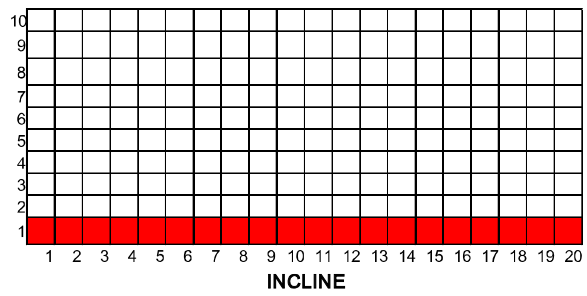

P5

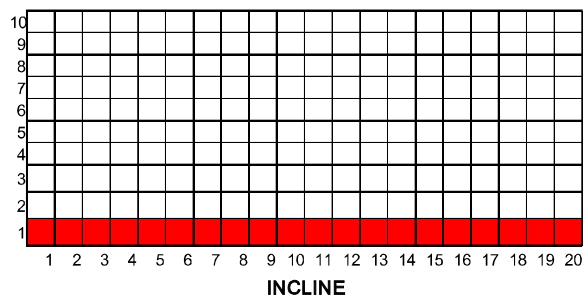

P6

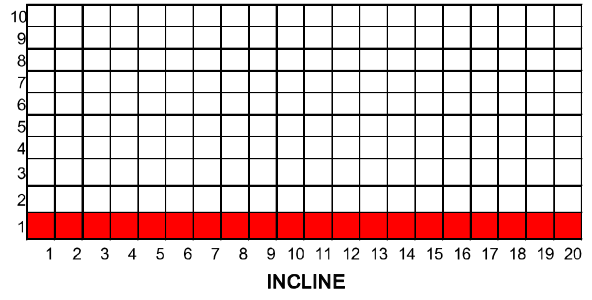
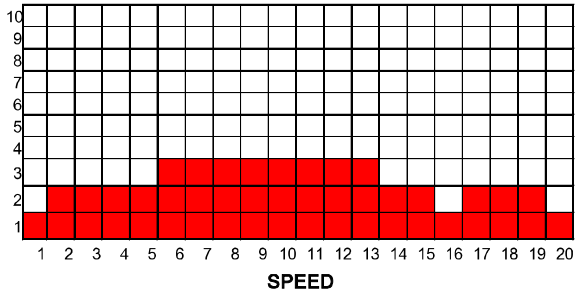

P7

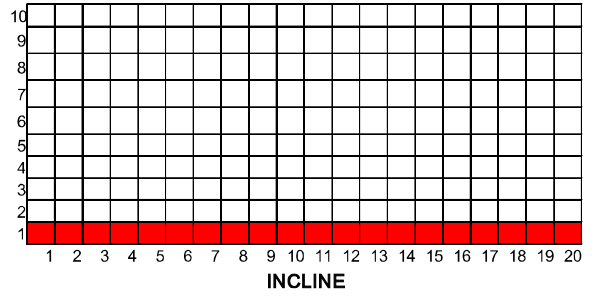
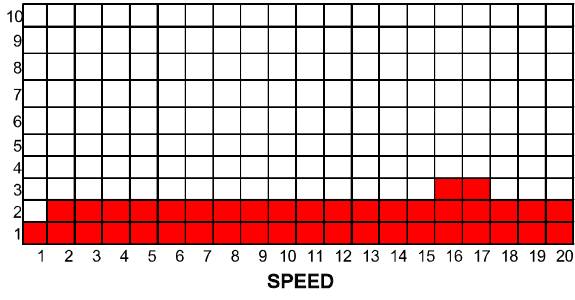

P8

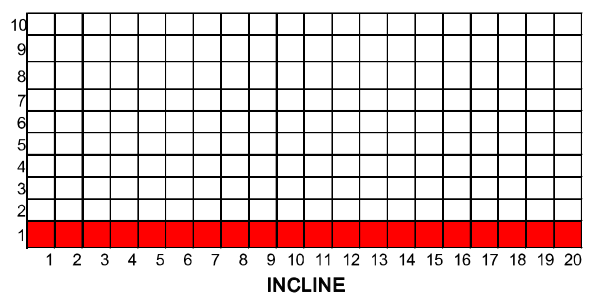
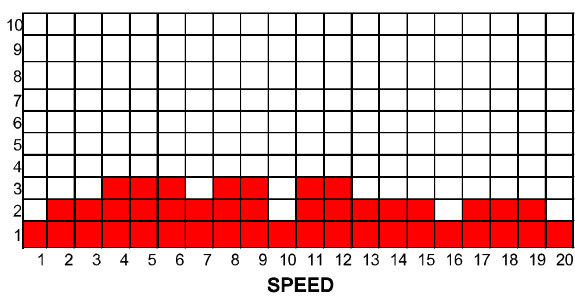

P9

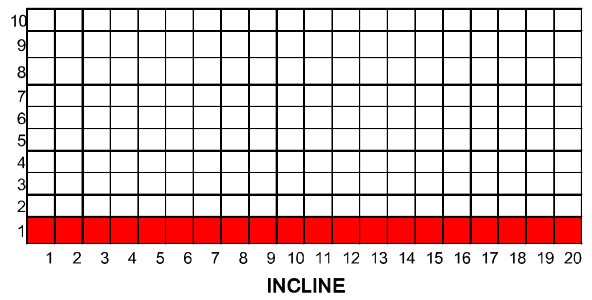

P10

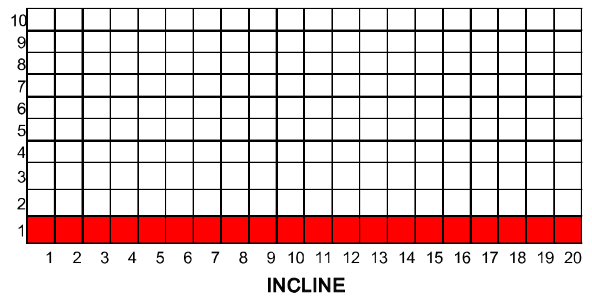
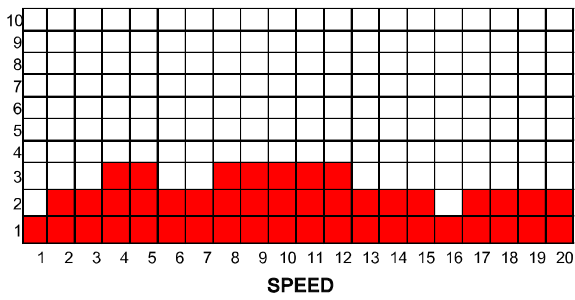

P11

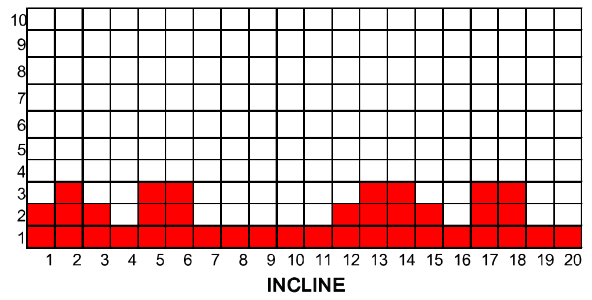
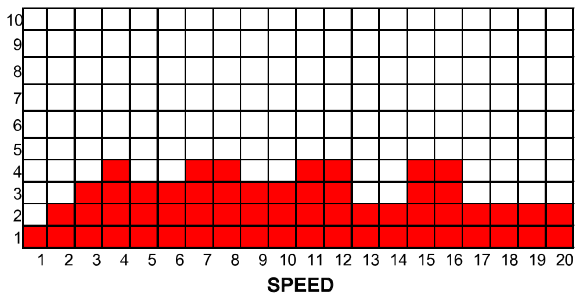

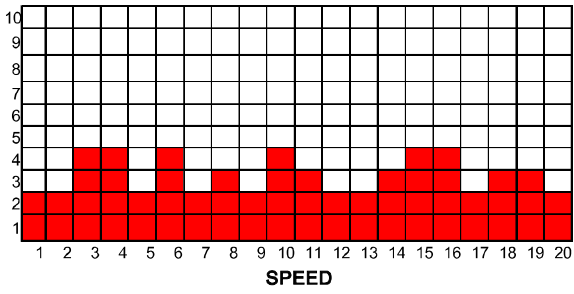

P12

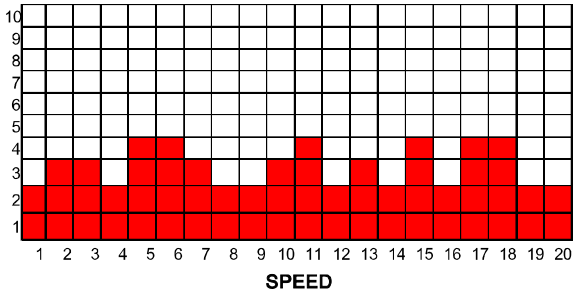
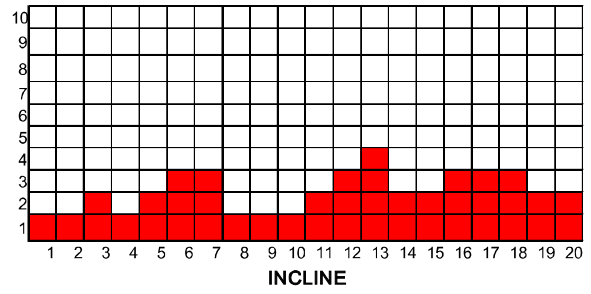

P13

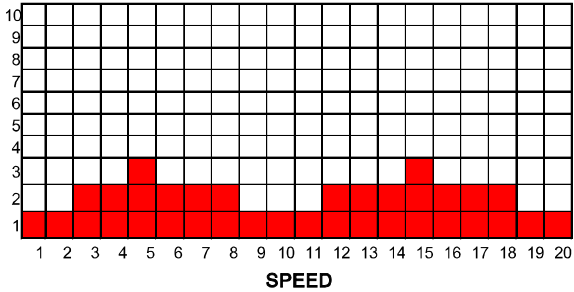
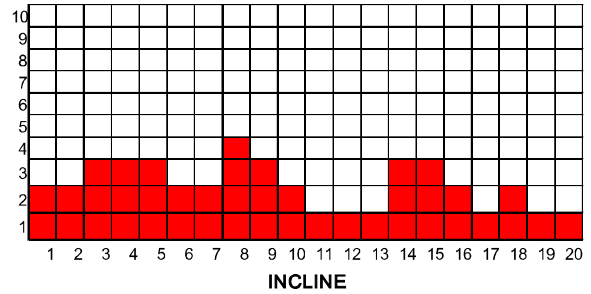

P14

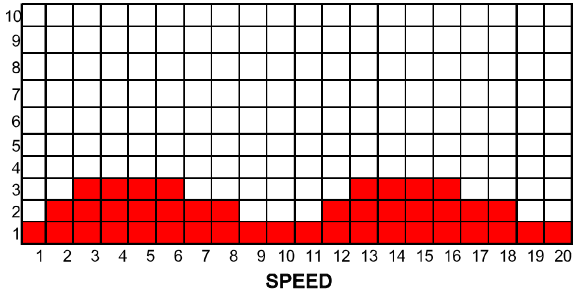
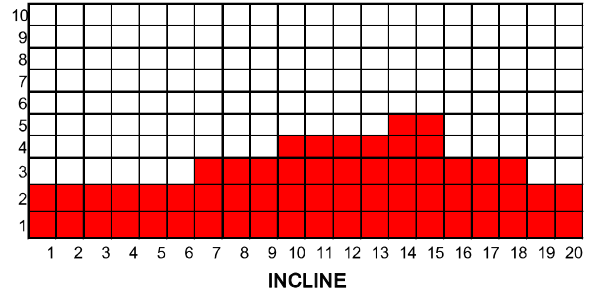

P15

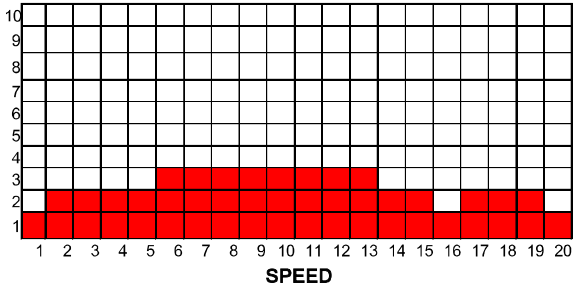
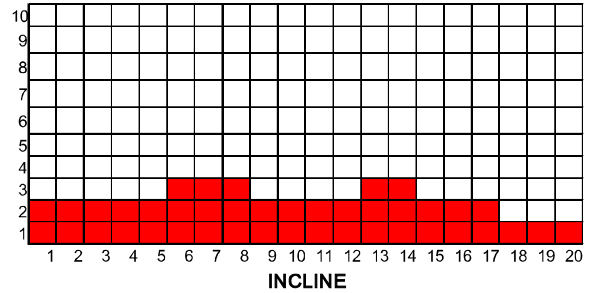

P16

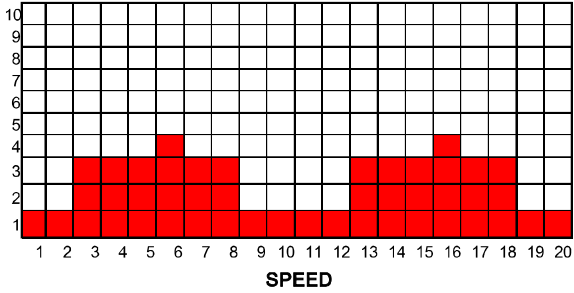
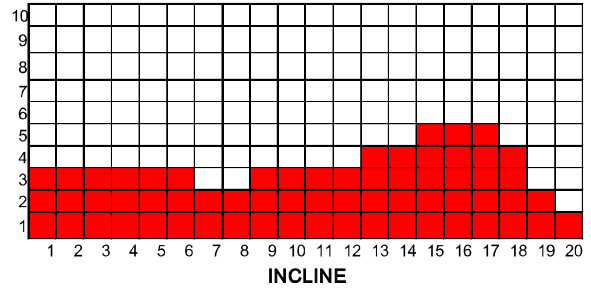

P17

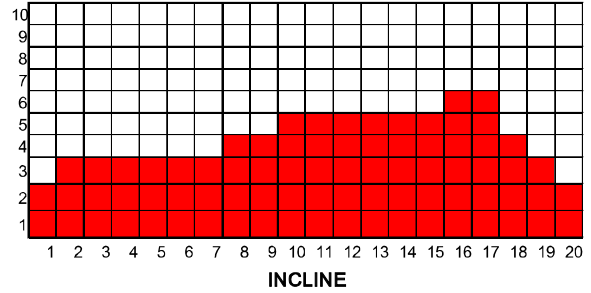

P18

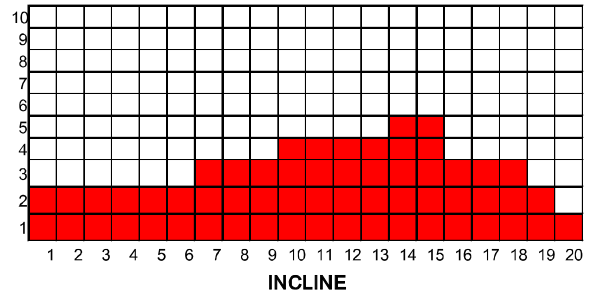
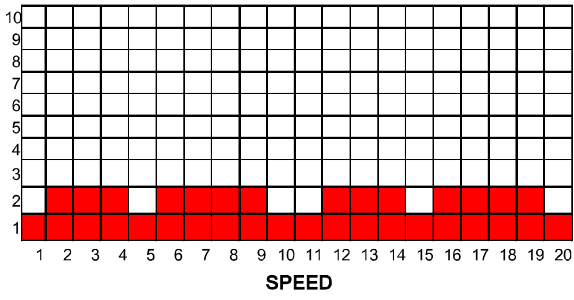

P19

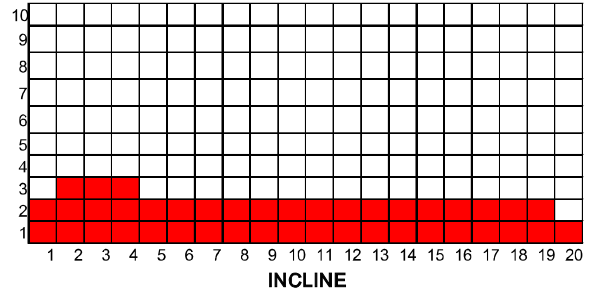
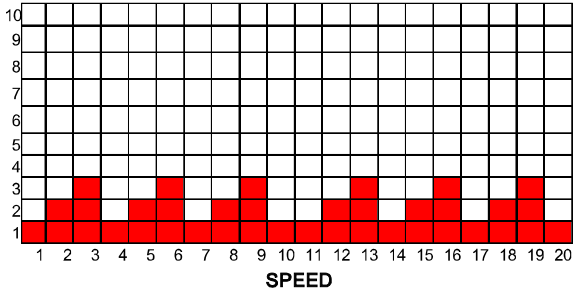

P20

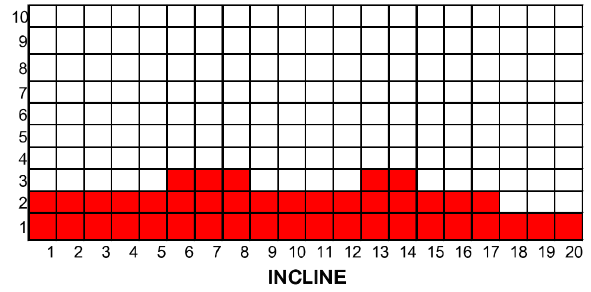
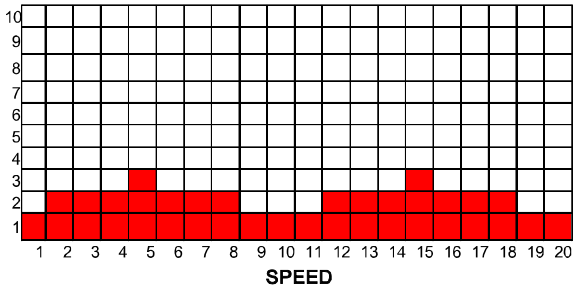

P21

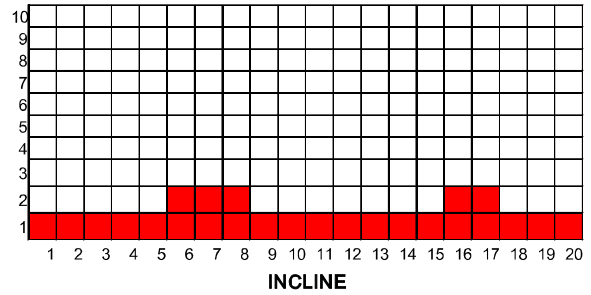
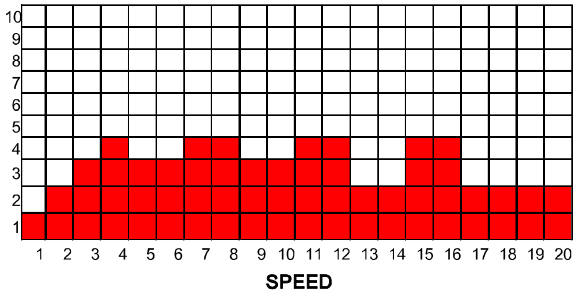

P22

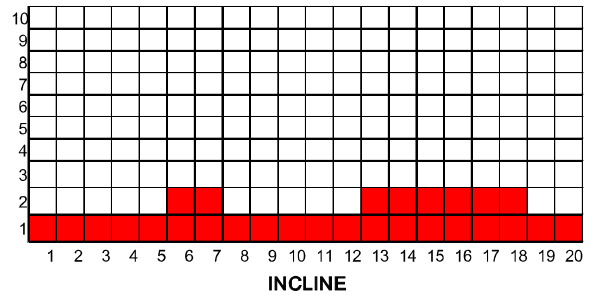
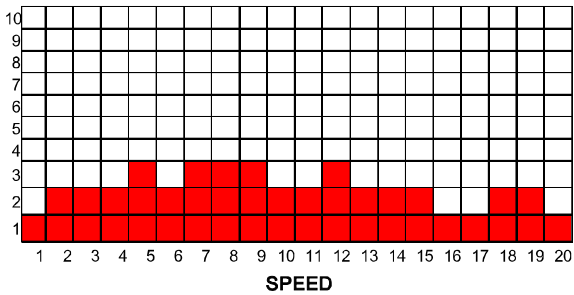

P23

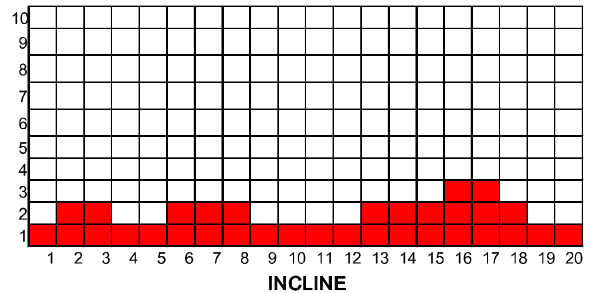
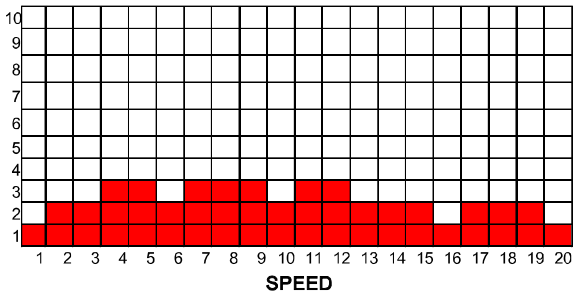

P24

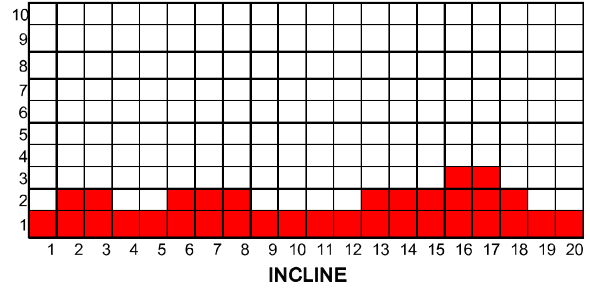
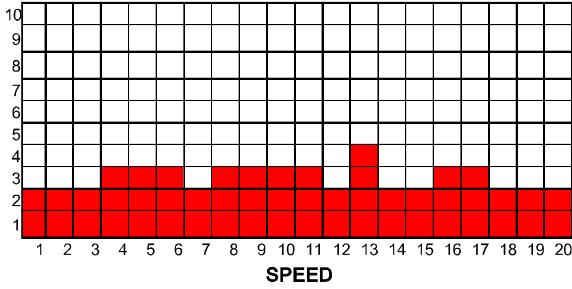

P#	TIME	TIME																			
		1	2	3	4	5	6	7	8	9	10	11	12	13	14	15	16	17	18	19	20
P1	SPEED	1.2	1.8	1.8	2.5	3.1	1.8	2.5	3.1	3.1	1.8	2.5	3.1	2.5	2.5	1.2	1.8	1.8	3.1	1.8	
P2	SPEED	1.2	2.5	2.5	3.1	3.7	2.5	3.7	3.7	3.7	2.5	3.1	3.7	2.5	2.5	1.2	1.2	3.1	2.5	1.2	
P3	SPEED	1.2	2.5	2.5	3.7	3.7	2.5	4.3	4.3	4.3	2.5	4.3	4.3	2.5	2.5	1.2	2.5	3.1	1.8	1.2	
P4	SPEED	1.8	3.1	3.1	3.7	4.3	4.3	3.1	4.3	4.3	5.0	5.0	3.1	5.6	3.1	3.1	3.7	3.7	2.5	2.5	
P5	SPEED	1.2	2.5	2.5	3.1	3.7	4.3	4.3	3.1	3.7	4.3	5.0	5.0	3.1	2.5	1.8	1.8	3.7	3.1	2.5	
P6	SPEED	1.2	2.5	2.5	2.5	3.1	3.7	5.0	5.0	3.7	4.3	5.0	5.0	3.7	2.5	2.5	1.2	3.1	2.5	1.8	
P7	SPEED	1.2	1.8	1.8	1.8	2.5	3.1	1.8	2.5	3.1	1.8	2.5	3.1	1.8	1.8	1.8	3.7	3.7	3.1	1.8	
P8	SPEED	1.2	1.8	1.8	3.7	4.3	4.3	2.5	3.7	4.3	2.5	3.7	4.3	2.5	2.5	2.5	1.2	1.8	2.5	2.5	
P9	SPEED	1.2	2.5	2.5	4.3	4.3	2.5	4.3	5.0	2.5	5.0	5.6	5.6	2.5	2.5	2.5	3.1	3.7	1.8	1.8	
P10	SPEED	1.2	2.5	3.1	3.7	4.3	3.1	2.5	3.7	5.0	5.0	3.7	3.7	3.1	2.5	2.5	1.2	2.5	2.5	1.8	
P11	SPEED	1.2	3.1	5.0	6.2	4.3	4.3	6.2	6.2	4.3	4.3	6.2	6.2	3.1	3.1	5.6	5.6	3.1	3.1	2.5	
	INCLINE	4	5	3	2	6	6	2	2	2	2	2	4	5	6	3	2	5	5	2	
P12	SPEED	1.8	2.5	5.6	5.6	3.1	5.6	3.1	5.0	3.1	5.6	4.3	3.1	3.1	4.3	5.6	5.6	3.1	4.3	3.7	
	INCLINE	1	2	3	2	3	5	5	0	0	2	3	5	7	3	3	5	6	5	3	
P13	SPEED	1.8	3.7	4.3	3.1	5.6	5.6	4.3	3.1	3.1	4.3	5.6	3.1	5.0	3.1	5.6	3.1	5.6	5.6	2.5	
	INCLINE	3	3	5	6	5	3	3	7	5	3	2	0	0	5	5	3	2	3	2	
P14	SPEED	1.2	1.2	2.5	3.1	3.7	3.1	2.5	1.8	1.2	0.6	1.2	1.8	2.5	3.1	3.7	3.1	2.5	1.8	1.2	
	INCLINE	4	4	4	4	3	3	6	6	6	7	7	8	8	9	9	6	6	5	4	
P15	SPEED	1.2	2.5	3.7	5.0	3.7	3.7	2.5	2.5	1.2	1.2	1.2	2.5	3.7	5.0	3.7	3.7	2.5	2.5	1.2	
	INCLINE	3	3	3	4	4	5	5	5	4	4	4	4	5	5	3	3	3	2	2	
P16	SPEED	1.2	2.5	2.5	2.5	3.1	3.7	5.0	5.0	3.7	4.3	5.0	5.0	3.7	2.5	2.5	1.2	3.1	2.5	1.8	
	INCLINE	5	5	5	6	6	6	4	4	6	6	5	5	8	8	9	9	9	7	4	
P17	SPEED	1.2	1.2	3.7	3.7	5.0	6.2	3.7	3.7	1.2	1.2	1.2	1.2	3.7	3.7	5.0	6.2	3.7	3.7	1.2	
	INCLINE	4	5	5	5	6	6	6	7	8	9	9	9	10	10	10	12	12	8	6	
P18	SPEED	1.2	1.8	2.5	3.1	1.2	1.8	2.5	3.1	1.8	1.2	1.2	1.8	2.5	3.1	1.2	1.8	2.5	3.1	1.8	
	INCLINE	4	4	4	4	3	3	6	6	6	7	7	8	8	9	9	6	6	5	3	
P19	SPEED	1.2	2.5	3.7	1.2	2.5	3.7	1.2	2.5	3.7	1.2	1.2	2.5	3.7	1.2	2.5	3.7	1.2	2.5	3.7	
	INCLINE	3	5	5	5	4	4	4	3	3	3	3	4	4	4	3	3	3	4	3	
P20	SPEED	0.6	1.8	2.5	3.1	3.7	3.1	2.5	1.8	1.2	0.6	0.6	1.8	2.5	3.1	3.7	3.1	2.5	1.8	1.2	
	INCLINE	3	3	3	4	4	5	5	5	4	4	4	4	5	5	3	3	3	2	2	
P21	SPEED	1.2	3.1	5.0	6.2	4.3	4.3	6.2	6.2	4.3	4.3	6.2	6.2	3.1	3.1	5.6	5.6	3.1	3.1	2.5	
	INCLINE	1	1	2	2	2	3	3	3	2	2	1	2	2	1	1	3	3	2	2	
P22	SPEED	1.2	2.5	2.5	3.1	3.7	2.5	3.7	3.7	3.7	2.5	3.1	3.7	2.5	2.5	2.5	1.2	1.2	3.1	2.5	
	INCLINE	1	2	2	2	2	3	3	2	2	2	2	2	3	3	3	4	4	3	2	
P23	SPEED	1.2	2.5	2.5	3.7	3.7	2.5	4.3	4.3	4.3	2.5	4.3	4.3	2.5	2.5	2.5	1.2	2.5	3.1	1.8	
	INCLINE	2	3	3	2	2	3	3	3	2	2	2	2	4	4	4	6	6	3	2	
P24	SPEED	1.8	3.1	3.1	3.7	4.3	4.3	3.1	4.3	4.3	5.0	5.0	3.1	5.6	3.1	3.1	3.7	3.7	2.5	2.5	
	INCLINE	2	3	3	2	2	3	3	3	2	2	2	2	4	4	4	6	6	3	2	

# HEART RATE PROGRAMS

The old motto, “no pain, no gain”, is a myth that has been overpowered by the benefits of exercising comfortably. A great deal of this success has been promoted by the use of heart rate monitors. With the proper use of a heart rate monitor, many people find that their usual choice of exercise intensity was either too high or too low and exercise is much more enjoyable by maintaining their heart rate in the desired benefit range.

To determine the benefit range in which you wish to train, you must first determine your Maximum Heart Rate. This can be accomplished by using the following formula: 220 minus your age. This will give you the Maximum Heart Rate (MHR) for someone of your age. To determine the effective heart rate range for specific goals you simply calculate a percentage of your MHR. Your Heart rate training zone is 50% to 90% of your maximum heart rate. 60% of your MHR is the zone that burns fat while 80% is for strengthening the cardiovascular system. This 60% to 80% is the zone to stay in for maximum benefit.

For someone who is 40 years old their target heart rate zone is calculated:

$$220 - 40 = 180 \text{ (maximum heart rate)}$$

$$180 \times .6 = 108 \text{ beats per minute}$$

(60% of maximum)

$$180 \times .8 = 144 \text{ beats per minute}$$

(80% of maximum)

So, for a 40-year-old the training zone would be 108 to 144 beats per minute.

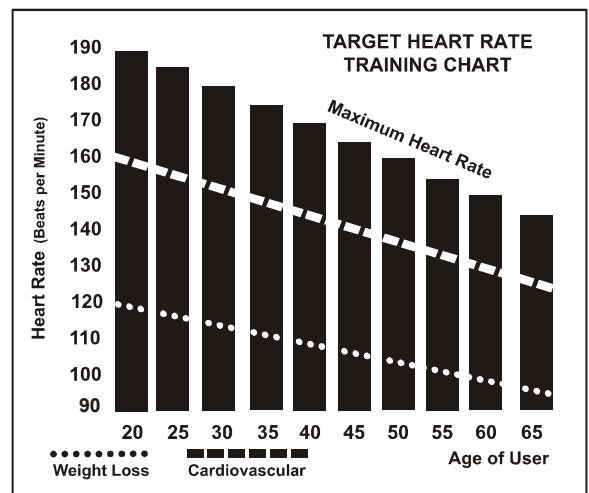

If you enter your age during programming the console will perform this calculation automatically. After calculating your MHR you can decide upon which goal you would like to pursue.

The two most popular reasons for, or goals, of exercise are cardiovascular fitness (training for the heart and lungs) and weight control. The black columns on the chart above represent the MHR for a person whose age is listed at the bottom of each column. The training heart rate, for either cardiovascular fitness or weight loss, is represented by two different lines that cut diagonally through the chart. A definition of the lines' goal is in the bottom left-hand corner of the chart. If your goal is cardiovascular fitness or if it is weight loss, it can be achieved by training at 80% or 60% respectively, of your MHR on a schedule approved by your physician. Consult your physician before participating in any exercise program.

# RATE OF PERCEIVED EXERTION

Heart rate is important but listening to your body also has a lot of advantages. There are more variables involved in how hard you should workout than just heart rate. Your stress level, physical health, emotional health, temperature, humidity, the time of day, the last time you ate and what you ate, all contribute to the intensity at which you should workout. If you listen to your body, it will tell you all of these things.

The rate of perceived exertion (RPE), also known as the Borg scale, was developed by Swedish physiologist G.A.V. Borg. This scale rates exercise intensity from 6 to 20 depending upon how you feel or the perception of your effort.

The scale is as follows:

## Rating Perception of Effort

- 6 Minimal
- 7 Very, very light
- 8 Very, very light +
- 9 Very light
- 10 Very light +
- 11 Fairly light
- 12 Comfortable
- 13 Somewhat hard
- 14 Somewhat hard +
- 15 Hard
- 16 Hard +
- 17 Very hard
- 18 Very hard +
- 19 Very, very hard
- 20 Maximal

You can get an approximate heart rate level for each rating by simply adding a zero to each rating. For example, a rating of 12 will result in an approximate heart rate of 120 beats per minute. Your RPE will vary depending up the factors discussed earlier. That is the major benefit of this type of training. If your body is strong and rested, you will feel strong and your pace will feel easier. When your body is in this condition, you are able to train harder and the RPE will support this. If you are feeling tired and sluggish, it is because your body needs a break. In this condition, your pace will feel harder. Again, this will show up in your RPE and you will train at the proper level for that day.

# PARTS DIAGRAM

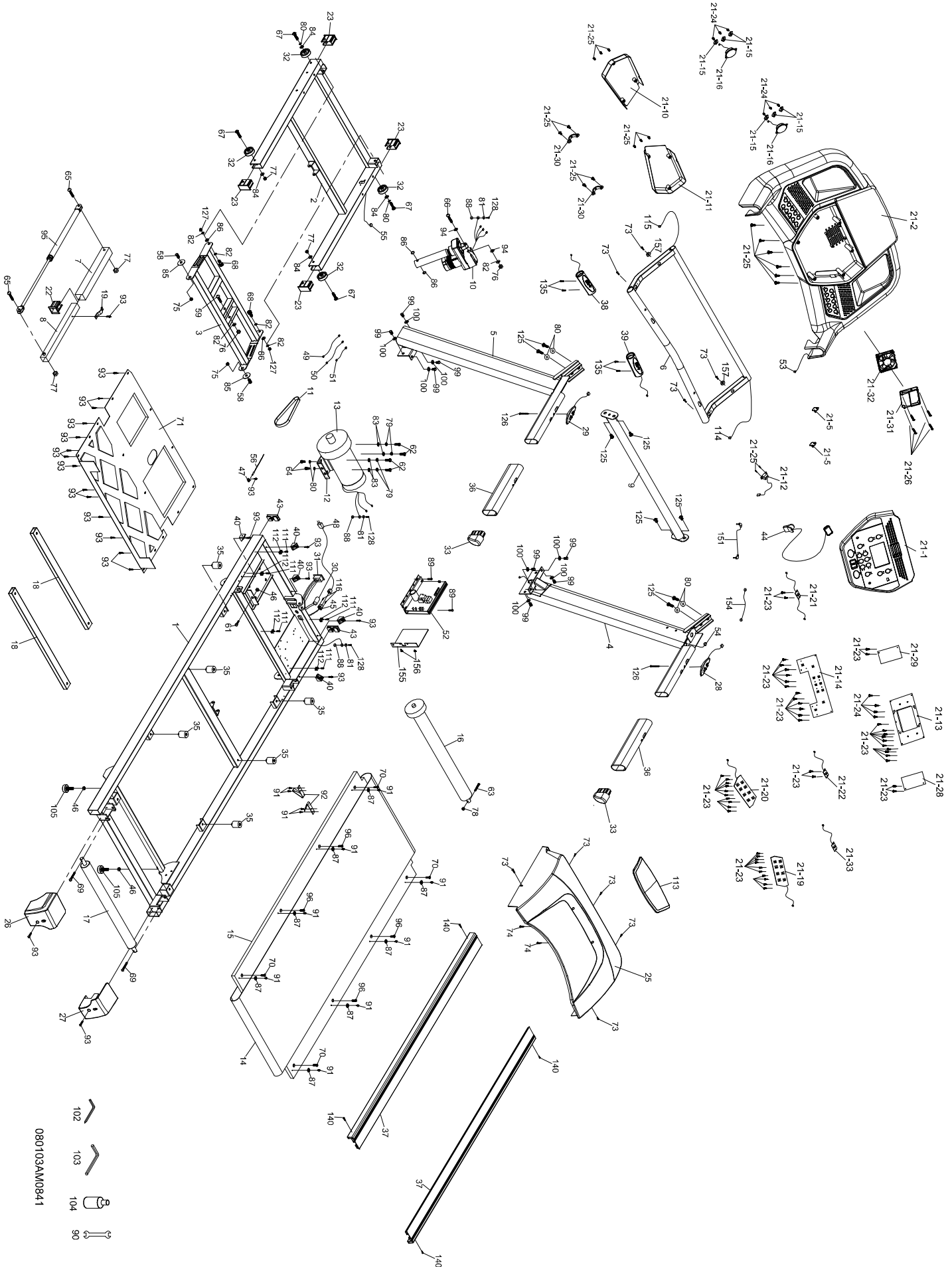

080103AM0841

- 102
- 103
- 104
- 90



# PARTS LIST

KEY NO.	PART NO.	DESCRIPTION	Q'TY
01	AA010188-S13	Main Frame	1
02	AA020067-S13	Frame Base	1
03	AA030046-S13	Incline Bracket	1
04	AA040250-S13	Right Upright	1
05	AA040251-S13	Left Upright	1
06	AA050136-S13	Console Support	1
07	AA060099-S13	Outer Slide	1
08	AA060100-Z2	Inner Slide	1
09	AA060098-S13	Outer Slide	1
10	G150001	Incline Motor	1
11	N010001	Drive Belt	1
12	B134029-Y3	Motor Bracket	1
13	CRG080606B	Drive Motor	1
14	H0613220H-QV	Running Belt	1
15	H140043	Running Deck	1
16	K140017-Z9	Front Roller W/Pulley	1
17	K140035-Z3	Rear Roller	1
18	A440095-S13	Deck Cross Brace	2
19	B130215-Z1	Sliding Tube Spring	1
21	CRZ4NT0350-20	Console Assembly	1
22	P040131-A1	Anti-Colliding Plug	1
23	P040132-A1	End Cap	4
25	CRP010104D-A1	Motor Top Cover	1
26	P030028-A1	Adjustment Base (L)	1
27	P030029-A1	Adjustment Base (R)	1
28	N110007A	300m/m_Speed Adjustment Switch W/Cable	1
29	N110002A	300m/m_Incline Adjustment Switch W/Cable	1
30	F020001	Breaker	1
31	F030001	AC Electronic Module	1
32	P050010-A1	Transportation Wheel	4
33	P040168-A1	Square End Cap	2
35	P060019-A1	Cushion	6
36	L220004-A1	Handgrip Foam	2
37	P080037L-A1	Foot Rail	2
38	F090257	1200m/m_Handpulse W/Cable Assembly (White)	1
39	F090257-01	1200m/m_Handpulse W/Cable Assembly (Red)	1
40	P060021-A1	Motor Cover Anchor(D)	5
43	P040002-A1	Square End Cap	2
44	N100003-A5	Square Safety Key	1
45	F010007	Power Socket	1
46	J129021-Y3	3/8" × UNC16 × 7T_Nut	3
47	P060022E-A1	Sensor Rack	1
48	E060001	Power Cord	1
49	E010754	300m/m_Connecting Wire (White)	1
50	E010755	300m/m_Connecting Wire (Black)	1
51	E010747	100m/m_Connecting Wire (Black)	1
52	D090060-02	Motor Controller	1

KEY NO.	PART NO.	DESCRIPTION	Q'TY
53	E020746-01	1000m/m Computer Cable (Upper)	1
54	E020725-02	1250m/m Computer Cable (Middle)	1
55	E020729-01	1200m/m Computer Cable (Lower)	1
56	F030185	1000m/m Sensor W/Cable	1
58	J011503-Y3	1/2" × 12UNC × 1" Hex Head Bolt	2
59	J011013R-ZN	3/8" × UNC16 × 3-1/4" Hex Head Bolt	1
61	J011006-Y3	3/8" × 1-1/2" Hex Head Bolt	1
62	J011002-Y3	3/8" × 3/4" Hex Head Bolt	4
63	J013012-Y3	M8 × 60m/m Hex Head Bolt	1
64	J013002-Y3	M8 × P1.25 × 12m/m Hex Head Bolt	2
65	J020512S-Y3	5/16" × UNC18 × 3" Button Head Socket Bolt	2
66	J011007P-ZN	3/8" × UNC16 × 1-3/4" Hex Head Bolt	1
67	J340506E-Y3	5/16" × 1-1/2" Flat Head Socket Bolt	4
68	J033505S-ZN	M10 × 25m/m Socket Head Cap Bolt	2
69	J033016-ZS	M8 × 80m/m Socket Head Cap Bolt	2
70	J043005-Y3	M8 × 25m/m Flat Head Countersink Bolt	4
71	P090115-A1	Motor Bottom Cover	1
73	J377105-Y3	5 × 16m/m Tapping Screw	9
74	J396804-Y3	3.5 × 12m/m Sheet Metal Screw	2
75	J139111-Y3	1/2" × 8T Nylon Nut	2
76	J139011-Y3	3/8" × 7T Nylon Nut	2
77	J139062-Y3	5/16" × 7T Nylon Nut	4
78	J139261-Y3	M8 × 7T Nylon Nut	1
79	J260001-Y3	Ø10 × 2.0T Split Washer	4
80	J260007-Y3	Ø8 × 1.5T Split Washer	8
81	J260008-Y3	Ø5 × 1.5T Split Washer	3
82	J210003-Y3	Ø3/8" × Ø19 × 1.5T Flat Washer	6
83	J210008-Y3	Ø3/8" × Ø25 × 2.0T Flat Washer	4
84	J210005-Y3	Ø5/16" × Ø18 × 1.5T Flat Washer	4
85	P060206-A1	Ø50 × Ø13 × 3T Nylon Washer (B)	2
86	P060221-A1	Ø24 × Ø10 × 3T Nylon Washer (A)	4
87	B130016-Z1	Ø25 × Ø20 × Ø16 × Ø5 × 4.5H × 1.1T Concave Washer	8
88	J270001-Z1	M5 Star Washer	3
89	J367111-Y3	Ø5 × 32m/m Tapping Screw	2
90	J330014-Z1	13m/m Wrench	1
91	J386904-Y3	4 × 12m/m Sheet Metal Screw	12
92	B133000-Z1	Belt Guide	2
93	J367105-Y3	Ø5 × 16m/m Tapping Screw	23
94	P060410-A1	Ø10 × Ø25 × 0.8T Nylon Washer	2
95	K060039A	Cylinder	1
96	J043010-Y3	M8 × 50m/m Flat Head Countersink Bolt	4
99	J010501-Y3	5/16" × UNC18 × 1/2" Hex Head Bolt	8
100	J210005-Y3	Ø5/16" × Ø18 × 1.5T Flat Washer	8
102	J330001-Y3	M5 Allen Wrench Head Screw Wrench	1
103	J330002-Y3	M6 L Allen Wrench	1
104	N020007A	Lubricant	1
105	P060018-A1	Adjustment Foot Pad	2
111	J536805-Y3	3.5 × 16m/m Tapping Screw	5
112	P060281	Wire Tie Mount	5

KEY NO.	PART NO.	DESCRIPTION	Q'TY
113	CRP010105-IE-02	Top Motor Cover Plate	1
114	E050205	1050m /m_Speed Cable (Upper)	1
115	E050254	1050m/m_Incline Cable (Upper)	1
116	J547003-Z1	3 × 10m/m_Sheet Metal Screw	2
125	J020502-Y3	5/16" × 3/4" Button Head Socket Bolt	8
126	J526914-Y3	Ø4 × 50m/m_Flat Head Socket Bolt	2
127	J139361-Y3	M10 × 8T_Nylon Nut	2
128	J092001-Y3	M5 × 10m/m_Phillips Head Screw	3
135	J517007-Y3	3 × 20m/m_Tapping Screw	4
140	J386915-Y3	Ø4 × 19m/m_Sheet Metal Screw	4
151	E090001	400m/m_Audio Cable	1
154	E040005	1000m/m_Ground Wire	1
155	B070005-S13	Controller Back Plate	1
156	J397002-Y3	3 × 8m/m_Sheet Metal Screw	2
157	J210017-Y3	Ø1/4" × 19 × 1.5T_Flat Washer	2

# GENERAL MAINTENANCE

## BELT ADJUSTMENTS:

**Tread-belt Tension Adjustment** - Belt tension is not critical for most users. It is very important for joggers and runners in order to provide a smooth, steady running surface. Adjustment must be made from the right side of the rear roller in order to adjust tension with the 6 mm Allen wrench provided in the parts package. The adjustment bolt is located at the end of the right-side rail as noted in diagram below.

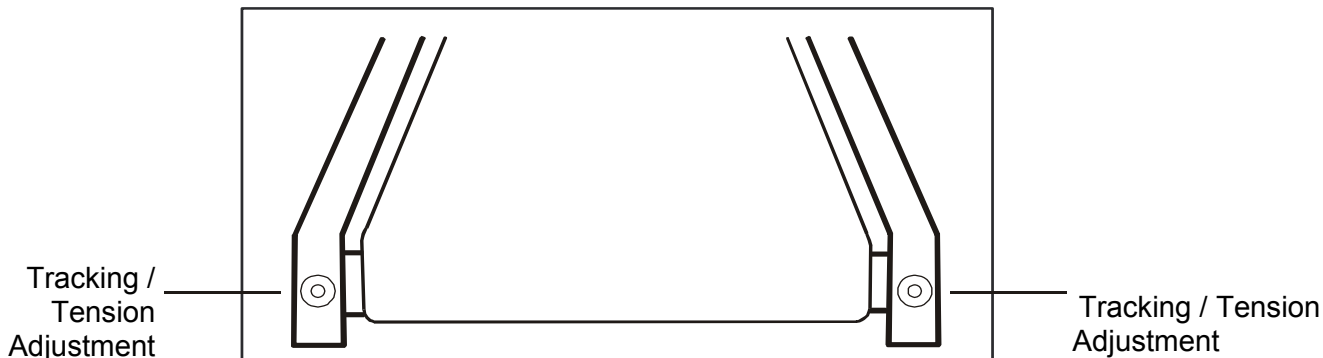

**Note:** Adjustment is through small hole in end cap.

Tighten the rear roller only enough to prevent slippage at the front roller. Turn the treadbelt tension adjusting bolt in increments of 1/4 turn and inspect for proper tension.

When an adjustment is made to the belt tension, you must also make a tracking adjustment to compensate for the change in belt tension. This is accomplished by turning both the tension and tracking Allen bolts an equal amount. This adjustment should be made by turning both bolts clockwise by no more than a 1/4 turn at a time.

**DO NOT OVERTIGHTEN** – Over tightening will cause belt damage and premature bearing failure.

## TREADBELT TRACKING ADJUSTMENT:

The performance of your treadmill is dependent on the frame running on a reasonably level surface. If the frame is not level, the front and back roller cannot run parallel, and constant belt adjustment may be necessary.

The treadmill is designed to keep the tread-belt reasonably centered while in use. It is normal for some belts to drift near one side while the belt is running with no one on it. After a few minutes of use, the tread-belt should have a tendency to center itself. If, during use, the belt continues to move toward one side, adjustments are necessary.

## TO SET TREADBELT TRACKING:

A 6 mm Allen wrench is provided to adjust the rear roller. Make tracking adjustments from the left and the right side. Set belt speed at approximately 2 to 3 mph. A small adjustment can make a dramatic difference. Turn the bolt only a 1/4 turn and wait a few minutes for the belt to adjust itself. Continue to make 1/4 turns until the belt stabilizes in the center of the running deck. The belt may require periodic tracking adjustment depending on use and walking/running

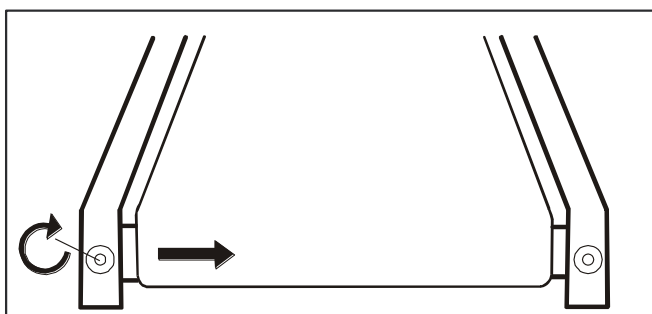

characteristics. Some users will affect tracking differently. Expect to make adjustments as required to center the tread-belt. Adjustments will become less of a maintenance concern as the belt is used. Proper belt tracking is an owner responsibility common with all treadmills.

**ATTENTION: DAMAGE TO THE RUNNING BELT RESULTING FROM IMPROPER TRACKING / TENSION ADJUSTMENTS IS NOT COVERED UNDER THE WARRANTY.**

## **BELT / DECK LUBRICATION:**

Do not lubricate with other than Dyaco approved lubricant. Your treadmill comes with one tube of lubricant and extra tubes can be ordered directly from Dyaco. There are commercially available lube kits, but the only one currently approved by Dyaco is Lube-N-Walk. These kits come with an application wand that makes applying the lubrication easier. Keeping the deck lubricated at the recommended intervals ensures the longest life possible for your treadmill. If the lubricant dries out, the friction between the belt and deck rises and places undue stress on the drive motor, drive belt and electronic motor control board, which could result in catastrophic failure of these expensive components. Failure to lubricate the deck at regular intervals may void the warranty.

The deck comes pre-lubricated and subsequent lubrication should be performed every 90 hours of use. To lubricate the deck with the tube of lubricant supplied it will be necessary to loosen the walking belt. Using the 6 mm allen wrench supplied, loosen the two rear roller adjustment bolts -- located in the rear end caps -- enough to get your hand under the belt (5 –10 turns). Make sure to loosen both bolts the same amount of turns and also remember how many turns, because when finished you will need to tighten the bolts back to the point they were before.

Once the belt is loose, wipe the deck with a clean lint free cloth to remove any dirt. Apply the whole tube of lubricant onto the deck surface about 18 inches from the motor cover. Squeeze out the contents of the tube across the deck (parallel to the motor cover) in about a one-foot long line, like toothpaste on a toothbrush. The one-foot line should be in the middle of the deck at approximately equal distance from both side edges of the belt. You want the lubricant to be applied about the spot that your feet would hit the belt as you are walking. This should be about 18 inches from the motor cover, but you may want to walk on the treadmill before loosening the belt to note where your feet land on the belt. If you mostly run on the treadmill, the spot where your feet land may be different from walking. Once the lubricant is applied, tighten the rear roller bolts the same amount of turns as when you loosened them. Run the treadmill at about 6 mph without walking on it for about a minute or two to make sure the belt stays in the middle of the deck. If the belt tracks to one side, then follow the belt tracking instructions to remedy. Now the deck is lubricated, and you should walk, not run, on the treadmill immediately for at least 5 minutes to ensure the lubricant is evenly distributed. If you purchase a Lube-N-Walk kit, follow the instructions that come with it to apply the lubrication.

## **GENERAL MAINTENANCE**



**WARNING:** Always unplug your treadmill prior to cleaning in order to avoid electrical hazard or shock.

**Belt and Deck** - Your treadmill uses a very high-efficient low-friction deck. Performance is maximized when the deck is kept as clean as possible. Use a soft, damp cloth or paper towel to wipe the edge of the belt and the area between the belt edge and frame. Also reach as far as practical directly under the belt edge. This should be done once a month to extend belt and deck life. Use water only - no cleaners or abrasives. A mild soap and water solution along with a nylon scrub brush will clean the top of the textured belt. Allow to dry before using.

**Belt Dust** - This occurs during normal break-in or until the belt stabilizes. Wiping excess off with a damp cloth will minimize buildup.

**General Cleaning** - Dirt, dust, and pet hair can block air inlets and accumulate on the running belt. On a monthly basis, vacuum underneath your treadmill to prevent buildup. Once a year, you should remove the black motor hood and vacuum out dirt that may accumulate. UNPLUG POWER CORD BEFORE THIS TASK.

Cleaning metal surfaces may be accomplished by using a soft cotton or terry cloth rag with a light application of car wax. Do not use aerosol sprays or pump bottles as they may deposit wax upon the walking or computer surface. Under no circumstances are you to use ammonia, oils, silicones, or any other compounds on the rubberized walking surface. The use of such materials may cause serious injury to the body and/or deteriorate the performance of the walking surface. Only clean the rubberized walking surface with a damp cloth (water only). From time-to-time the computer surface may collect dust or fingerprints. The use of harsh chemicals will destroy the protective coating and cause a static build up that will damage the components. This surface may be cleaned with specially prepared chemicals found in most computer supply stores especially made for anti-static surfaces. It is strongly recommended that you purchase such a cleaning compound.

### **TREADMILL LUBRICATION**

Your treadmill should require little maintenance other than periodically applying lubricant. Lubricating under the tread-belt will ensure superior performance and extend its life expectancy.

### **HOW TO CHECK IF THE TREADBOARD REQUIRES LUBRICATION**

Lift one side of the tread-belt and feel the top surface of the tread board. If the surface is (slick) to the touch, then no further lubrication is required. If the surface is dry to the touch, apply one packet of lubricant or half of the bottle of lubricant.

## RESET SWITCH RESETTING

- If your treadmill loses power or will not start, check the reset switch located on the front of the motor cover.
- If the white tab of the reset switch is not showing, then the reset switch has not been tripped.
- If the white tab of the reset switch is showing, the reset switch has tripped.

### To reset the reset switch:

- Remove the safety clip on console.
- Press white tab of the reset switch in until it snaps back into place.
- If the reset switch continues to trip - see tread-belt adjustment and tread-belt lubrication

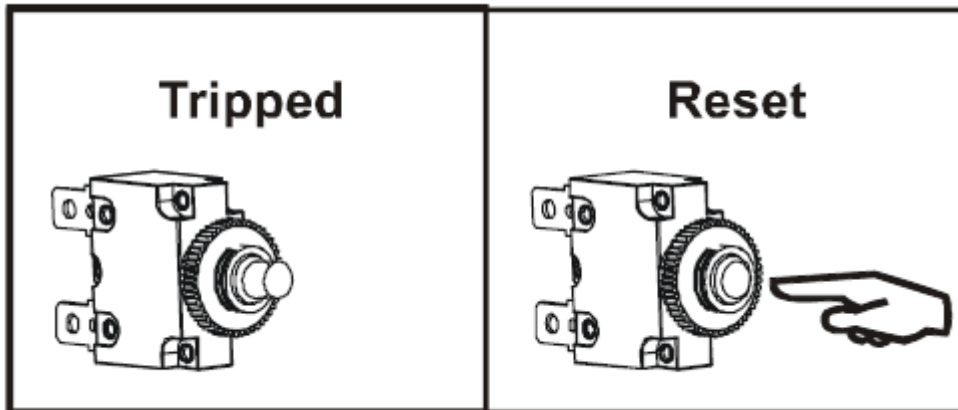

## SPEED SENSOR ADJUSTMENT

If the monitor does not display in the calibration mode, the speed sensor and magnet may be misaligned. **(ONLY IN CALIBRATION MODE)**

**Note: Always unplug your treadmill prior to cleaning in order to avoid electrical hazard or shock.**

### Follow these steps to check and realign.

- Remove the motor cover
- Check the spacing and alignment between the magnet on the right side of the front roller and the speed sensor on the frame. The spacing must be 1/8".
- Loosen screw and slide speed sensor in or out of clamp.
- Retighten screw and replace the motor cover.

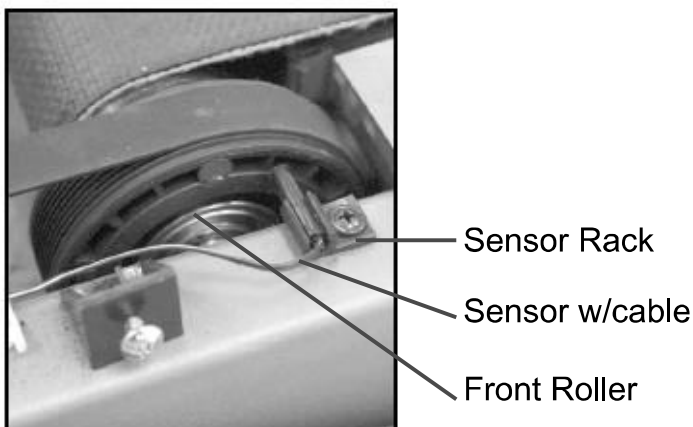

# Service Checklist – Diagnosis Guide

Before contacting your dealer for aid, please review the following information. It may save you both time and expense. This list includes common problems that may not be covered under the treadmill's warranty.

PROBLEM	SOLUTION/CAUSE
<b>Display does not light.</b>	<ol style="list-style-type: none"> <li>1. Tether cord not in position.</li> <li>2. Circuit breaker on front grill tripped. Push circuit breaker in until it locks.</li> <li>3. Plug is disconnected. Make sure plug is firmly pushed into AC household wall outlet.</li> <li>4. Household circuit breaker may be tripped.</li> <li>5. Treadmill defect. Contact your dealer.</li> </ol>
<b>Tread-belt does not stay centered Treadmill belt hesitates when walk or run on.</b>	<p>The user may be walking while favoring or putting more weight on either the left or right foot. If this walking pattern is natural, track the belt slightly off-center to the side opposite from the belt movement. See <b>General Maintenance</b> section on <b>Tread-belt Tension</b>. Adjust as necessary.</p>
<b>Motor is not responsive after pressing start.</b>	<p>Contact the service department</p>
<b>Treadmill will only achieve approximately 8 kph (5 mph) but shows higher speed on display.</b>	<p>This indicates motor should be receiving power to operate. Low AC voltage to treadmill. Do not use an extension cord. If an extension cord is required, it should be as short as possible and heavy duty 14 gauge minimum. Low household voltage. Contact an electrician or your dealer. A minimum of 110 volt AC current is required.</p>
<b>Tread-belt stops quickly/ suddenly when tether cord is pulled.</b>	<p>High belt/deck friction. See <b>General Maintenance</b> section on lubrication.</p>
<b>Treadmill trips on board 15 amp circuit.</b>	<p>High belt/deck friction. See <b>General Maintenance</b>.</p>
<b>Computer shuts off when console is touched (on a cold day) while walking/running.</b>	<p>Treadmill may not be grounded. Static electricity is "crashing" the computer. Refer to <b>Grounding Instructions</b>.</p>
<b>House circuit breaker trips, but not the treadmill circuit breaker.</b>	<p>Need to replace the house breaker with a "High In-rush current" type breaker.</p>



# TROUBLESHOOTING

## How to enter factory settings to change from miles to kilometers

Remove the safety key. Press and hold the PROGRAM button and reinsert the safety key. Release the PROGRAM button **after** reinserting the safety key. Press the ENTER button once to select miles or km (0 is miles and 1 is KM). Press the speed ▲ / ▼ button to change the values in each menu. Roller diameter (60), speed (0.5mph to 12mph, or 1km to 18km) and incline 12. Stand beside the treadmill and press the START button to start the calibration procedure. The treadmill will begin to calibrate itself and will leave the factory settings mode once the operation is completed.

Do not modify any values other than English vs Metric (Miles vs Kilometers).

Error Messages and Troubleshooting for Digital-Control System Treadmills			
Error	Meaning	Possible cause	
Console showing E0	Safety Switch Malfunction	1. If safety key is placed properly?	Place properly
		2. Is safety key defective?	Replace safety key
Console showing E1 Only in calibration mode	Missing speed signal	1. Check and make sure speed sensor is connected	Connect the speed sensor
		2. Speed sensor is defective	Replace the speed sensor
Console showing E2	Over current protection Treadmill over loaded, controller protection is activated.	1. Check and make sure of proper walking belt alignment. Make sure of periodic lubrication to minimize belt resistance.	See general maintenance
		2. Any roller bearing damage?	Replace roller
		3. motor overheated?	Replace motor
Console showing E3	Incline Error	1. Is the cable between incline motor and controller connected correctly and properly?	Connect properly
		2. Check if incline mechanism being stock or defective?	Replace incline motor
		3. Is VR connected properly or with intermittence?	Replace incline motor
Console showing E4	Improper motor input voltage	1. Motor is not connected properly or even not connected to the controller.	Connect properly
Console showing E5	Communication disconnected between the console and the controller or communication error.	1. check and make sure of proper connection between the console and the controller.	Connect properly or replace cables
Console showing E6	Controller malfunction	1. Controller component failure (e.g. IGBT)	Replace controller
Console showing E7	Abnormal power input	1. check and make sure of proper voltage input for the treadmill.	

# TRAINING GUIDELINES

## Exercise

Exercise is one of the most important factors in the overall health of an individual. Listed among its benefits are:

- Increased capacity for physical work (strength endurance)
- Increased cardiovascular (heart and arteries/veins) and respiratory efficiency
- Decreased risk of coronary heart disease
- Changes in body metabolism, e.g. losing weight
- Delaying the physiological effects of age
- Physiological effects, e.g. reduction in stress, increase in self-confidence, etc.

## Basic Components of Physical Fitness

There are four all-encompassing components of physical fitness and we need to briefly define each and clarify its role.

**Strength** is the capacity of a muscle to exert a force against resistance. Strength contributes to power and speed and is of great importance to a majority of sports people.

**Muscular Endurance** is the capacity to exert a force repeatedly over a period of time, e.g. it is the capacity of your legs to carry you 10 Km without stopping.

**Flexibility** is the range of motion about a joint. Improving flexibility involves the stretching of muscles and tendons to maintain or increase suppleness and provides increased resistance to muscle injury or soreness.

**Cardio-Respiratory Endurance** is the most essential component of physical fitness. It is the efficient functioning of the heart and lungs

## Aerobic Fitness

The largest amount of oxygen that you can use per minute during exercise is called your maximum oxygen uptake (MVo<sub>2</sub>). This is often referred to as your aerobic capacity. The effort that you can exert over a prolonged period of time is limited by your ability to deliver oxygen to the working muscles. Regular vigorous exercise produces a training effect that can increase your aerobic capacity by as much as 20 to 30%. An increased MVo<sub>2</sub> indicates an increased ability of the heart to pump blood, of the lungs to ventilate oxygen and of the muscles to take up oxygen.

## Anaerobic Training

This means “without oxygen” and is the output of energy when the oxygen supply is insufficient to meet the body’s long-term energy demands. (For example, 100 meter sprint).

## The Training Threshold

This is the minimum level of exercise which is required to produce significant improvements in any physical fitness parameter.

## Progression

As you become fitter, a higher intensity of exercise is required to create an overload and therefore provide continued improvement

## Overload

This is where you exercise at a level above that which can be carried out comfortably. The intensity, duration and frequency of exercise should be above the training threshold and should be gradually increased as the body adapts to the increasing demands. As your fitness level improves, so the training threshold should be raised. Working through your program and gradually increasing the overload factor is important.

## Specificity

Different forms of exercise produce different results. The type of exercise that is carried out is specific both to the muscle groups being used and to the energy source involved. There is little transfer of the effects of exercise, i.e. from strength training to cardiovascular fitness. That is why it is important to have an exercise program tailored to your specific needs.

## Reversibility

If you stop exercising or do not do your program often enough, you will lose the benefits you have gained. Regular workouts are the key to success.

## WARM UP

Every exercise program should start with a warmup where the body is prepared for the effort to come. It should be gentle and preferably use the muscles to be involved later. Stretching should be included in both your warmup and cool down and should be performed after 3-5 minutes of low intensity aerobic activity or callisthenic type exercise.

## Warm Down or Cool Down

This involves a gradual decrease in the intensity of the exercise session. Following exercise, a large supply of blood remains in the working muscles. If it is not returned promptly to the central circulation, pooling of blood may occur in the muscles

## Heart Rate

As you exercise, so the rate at which your heart beat also increases. This is often used as a measure of the required intensity of exercise. You need to exercise hard enough to condition your circulatory system, and increase your pulse rate, but not enough to strain your heart.

Your initial level of fitness is important in developing an exercise program for you. If you are starting off, you can get a good training effect with a heart rate of 110-120 beats per minute (BPM). If you are fitter, you will need a higher threshold of stimulation.

To begin with, you should exercise at a level that elevates your heart rate to about 65 to 70% of your maximum. If you find this is too easy, you may want to increase it, but it is better to lean on the conservative side.

As a rule of thumb, the maximum heart rate is 220 minus your age. As you increase in age, so your heart, like other muscles, loses some of its efficiency. Some of its natural loss is won back as fitness improves.

The following table is a guide to those who are "starting fitness".

Age	25	30	35	40	45	50	55	60	65
Target heart Rate									
10 Second Count	23	22	22	21	20	19	19	18	18
Beats per Minute	138	132	132	126	120	114	114	108	108
Pulse Count									

The pulse count (on your wrist or carotid artery in the neck, taken with two index fingers) is done for ten seconds, taken a few seconds after you stop exercising. This is for two reasons: (a) 10 seconds is long enough for accuracy, (b) the pulse count is to approximate your BPM rate at the time you are exercising. Since heart rate slows as you recover, a longer count isn't as accurate.

The target is not a magic number, but a general guide. If you're above average fitness, you may work quite comfortably a little above that suggested for your age group.

The following table is a guide to those who are keeping fit. Here we are working at about 80% of maximum.

Age	25	30	35	40	45	50	55	60	65
Target heart Rate 10 Second Count	26	26	25	24	23	22	22	21	20
Beats per Minute	156	156	150	144	138	132	132	126	120

Don't push yourself too hard to reach the figures on this table. It can be very uncomfortable if you overdo it. Let it happen naturally as you work through your program. Remember, the target is a guide, not a rule, a little above or below is just fine.

Two final comments: (1) don't be concerned with day to day variations in your pulse rate, being under pressure or not enough sleep can affect it; (2) your pulse rate is a guide, don't become a slave to it.

## Endurance Circuit Training

Cardiovascular endurance, muscle, strength, flexibility and coordination are all necessary for maximum fitness. The principle behind circuit training is to give a person all the essentials at one time by going through your exercise program moving as fast as possible between each exercise. This increases the heart rate and sustains it, which improves the fitness level. Do not introduce this circuit training effect until you have reached an advanced program stage.

## Body Building

Is often used synonymously with strength training. The fundamental principal here is OVERLOAD. Here, the muscle works against greater loads than usual. This can be done by increasing the load you are working against.

## Patronization

This is the term used to vary your exercise program for both physiological and psychological benefits. In your overall program, you should vary the workload, frequency and intensity. The body responds better to variety and so do you. In addition, when you feel yourself getting "stale", bring in periods of lighter exercise to allow the body to recuperate and restore its reserves. You will enjoy your program more and feel better for it.

## Muscle Soreness

For the first week or so, this may be the only indication you have that you are on an exercise program. This, of course, does depend on your overall fitness level. A confirmation that you are on the correct program is a very slight soreness in most major muscle groups. This is quite normal and will disappear in a matter of days.

If you experience major discomfort, you may be on a program that is too advanced, or you have increased your program too rapidly.

If you experience PAIN during or after exercise, your body is telling you something.

Stop exercising and consult your doctor.

## **What to Wear**

Wear clothing that will not restrict your movement in any way while exercising. Clothes should be light enough to allow the body to cool. Excessive clothing that causes you to perspire more than you normally would while exercising, gives you no advantage. The extra weight you lose is body fluid and will be replaced with the next glass of water you drink. It is advisable to wear a pair of gym or running shoes or “sneakers”.

## **Breathing during Exercise**

Do not hold your breath while exercising. Breathe normally as much as possible. Remember, breathing involves the intake and distribution of oxygen, which feeds the working muscles.

## **Rest periods**

Once you start your exercise program, you should continue through to the end. Do not break off halfway through and then restart at the same place later on without going through the warm-up stage again.

The rest period required between strength training exercises may vary from person to person. This will depend mostly on your level of fitness and the program you have chosen. Rest between exercises by all means, but do not allow this to exceed two minutes. Most people manage with half minute to one-minute rest periods

# STRETCHING

Stretching should be included in both your warmup and cool down and should be performed after 3-5 minutes of low intensity aerobic activity or callisthenic type exercise. Movements should be performed slowly and smoothly, with no bouncing or jerking. Move into the stretch until slight tension, not pain, is felt in the muscle and hold for 20-30 seconds. Breathing should be slow, rhythmical and under control, making sure never to hold your breath.

## HEAD ROLLS

Rotate your head to the right for one count, feeling the stretch up the left side of your neck. Next rotate your head back for one count, stretching your chin to the ceiling and letting your mouth open. Rotate your head to the left for one count, and finally, drop your head to your chest for one count.

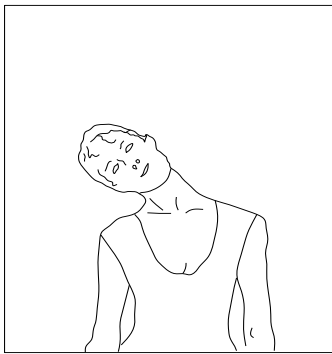

## SHOULDER LIFTS

Lift your right shoulder up toward your ear for one count. Then lift your left shoulder up for one count as you lower your right shoulder.

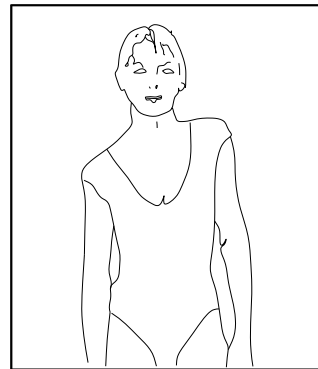

## SIDE STRETCHES

Open your arms to the side and continue lifting them until they are over your head. Reach your right arm as far upward toward the ceiling as you can for one count. Feel the stretch up your right side. Repeat this action with your left arm.

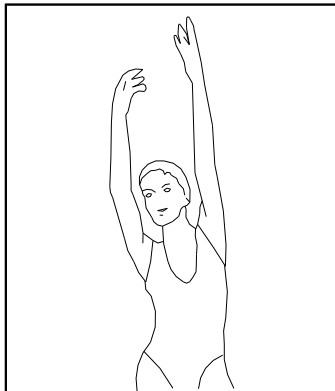

## QUADRICEPS STRETCH

With one hand against a wall for balance, reach behind you and pull your right foot up. Bring your heel as close to your buttocks as possible. Hold for 15 counts and repeat with left foot up.

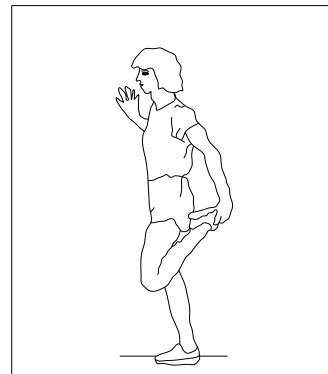

### **INNER THIGH STRETCH**

Sit with the soles of your feet together with your knees pointing outward. Pull your feet as close into your groin as possible. Gently push your knees towards the floor. Hold for 15 counts.

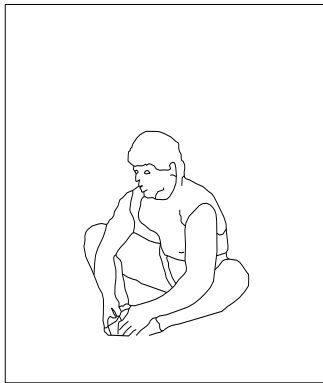

### **TOUCHES**

Slowly bend forward from your waist, letting your back and shoulders relax as you stretch toward your toes. Reach down as far as you can and hold for 15 counts.

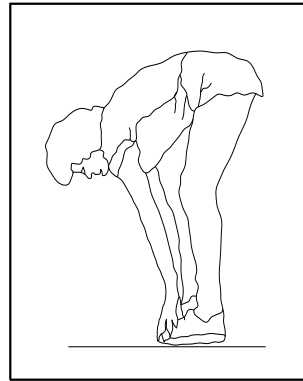

### **HAMSTRING STRETCHES**

Sit with your right leg extended. Rest the sole of your left foot against your right inner thigh. Stretch your toe as far as possible. Hold for 15 counts. Relax and then repeat with left leg extended.

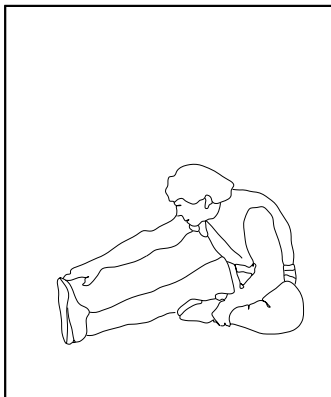

### **CALF / ACHILLES STRETCH**

Lean against a wall with your left leg in front of the right and your arms forward. Keep your right leg straight and the left foot on the floor then bend the left leg and lean forward by moving your hips toward the wall. Hold, then repeat on the other side for 15 counts.

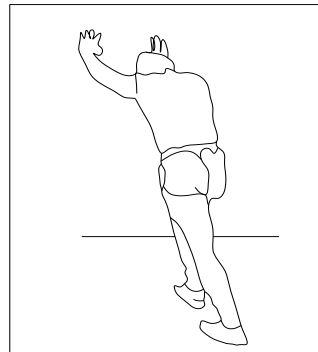

# MANUFACTURER'S LIMITED WARRANTY

Dyaco Canada Inc. warrants all its treadmill parts for a period of time listed below from the date of retail sale, as determined by sale receipt. Dyaco Canada Inc.'s responsibilities include providing new or remanufactured parts, at Dyaco Canada Inc.'s option, and technical support to our independent dealers and servicing organizations. In the absence of a dealer or service organization, these warranties will be administered by Dyaco Canada Inc. directly to a consumer. The warranty period applies to the following components:

<b>Frame</b>	Lifetime
<b>Motor</b>	Lifetime
<b>Labour</b>	1 Year
<b>All other components</b>	1 Year

The consumer is responsible for the items listed below:

1. The warranty registration card must be completed and returned to the address listed on the card within 10 days of the original purchase.
2. Proper use of the treadmill in accordance with the instructions provided in this manual.
3. Proper installation in accordance with instructions provided with the treadmill and with all local electric codes.
4. Proper connection to a grounded power supply of sufficient voltage, replacement of blown fuses, repair of loose connections or defects in house wiring.
5. Expenses for making the treadmill accessible for servicing, including any item that was not part of the treadmill at the time it was shipped from the factory.
6. Damages to the treadmill finish during shipping, installation or following installation.
7. Routine maintenance of this unit as specified in this manual.

## EXCLUSIONS

This warranty does not cover the following:

1. CONSEQUENTIAL, COLLATERAL, OR INCIDENTAL DAMAGES SUCH AS PROPERTY DAMAGE AND INCIDENTAL EXPENSES RESULTING FROM ANY BREACH OF THIS WRITTEN OR ANY IMPLIED WARRANTY.  
Note: Some areas do not allow the exclusion or limitation of incidental or consequential damages, so this limitation or exclusion may not apply to you.
2. Service call reimbursement to the consumer. Service call reimbursement to the dealer that does not involve malfunction or defects in workmanship or material, for units that are beyond the warranty period, for units that are beyond the service call reimbursement period, for treadmill not requiring component replacement, or treadmill not in ordinary household use.
3. Damages caused by services performed by persons other than authorized Dyaco Canada Inc. service companies; use of parts other than original Dyaco Canada Inc. parts; or external causes such as corrosion, discoloration of paint or plastic, alterations, modifications, abuse, misuse, accident, improper maintenance, inadequate power supply, or acts of God.
4. Products with original serial numbers that have been removed or altered.
5. Products that have been: sold, transferred, bartered, or given to a third party.
6. Products that do not have a warranty registration card on file at Dyaco Canada Inc. Dyaco Canada Inc. reserves the right to request proof of purchase if no warranty record exists for the product.
7. THIS WARRANTY IS EXPRESSLY IN LIEU OF ALL OTHER WARRANTIES EXPRESSED OR IMPLIED, INCLUDING THE WARRANTIES OF MERCHANTABILITY AND/OR FITNESS FOR A PARTICULAR PURPOSE.
8. Use of the product in a non-residential environment.
9. Warranties outside of Canada may vary. Please contact your local dealer or Dyaco Canada for details.

## SERVICE

The sales receipt establishes the labour warranty period should service be required. If service is performed, it is in your best interest to obtain and keep all receipts. This written warranty gives you specific legal rights. Service under this warranty must be obtained by following these steps, in order:

1. Contact your selling authorized dealer or Dyaco Canada.
2. If you have any questions about your new product or questions about the warranty contact Dyaco Canada Inc. at 1-888-707-1880.
3. If no local service is available, Dyaco Canada Inc. will repair or replace the parts, at Dyaco Canada Inc.'s option, within the warranty period at no charge for parts. All transportation costs, both to our factory and upon return to the owner, are the responsibility of the owner.
4. The owner is responsible for adequate packaging upon return to Dyaco Canada Inc. Dyaco Canada Inc. is not responsible for damages that occur during shipping. Make all freight damage claims with the appropriate freight carrier. DO NOT SHIP ANY UNIT TO OUR FACTORY WITHOUT A RETURN AUTHORIZATION NUMBER. All units arriving without a return authorization number will be refused.
5. For any further information, or to contact our service department by mail, send your correspondence to:

Dyaco Canada Inc.  
5955 Don Murie Street  
Niagara Falls, ON  
L2G 0A9

Product features or specifications as described or illustrated are subject to change without notice. All warranties are made by Dyaco Canada Inc.



# dyaco

Please visit us online for information about our other brands and products manufactured and distributed by Dyaco Canada Inc.

**SPIRIT**

[spiritfitness.ca](http://spiritfitness.ca)

**XTEERRA**

[xterrafitness.ca](http://xterrafitness.ca)

**UFC**

[dyaco.ca/UFC/UFC-home.html](http://dyaco.ca/UFC/UFC-home.html)

**SOLE**  
FITNESS

[solefitness.ca](http://solefitness.ca)

**EVERLAST**

[dyaco.ca/products/everlast.html](http://dyaco.ca/products/everlast.html)

**Johnny G**  
by **SPIRIT**

[spiritfitness.ca/johnnyg.html](http://spiritfitness.ca/johnnyg.html)

**TRINOR**  
**SPORTS**

[trainorsports.ca](http://trainorsports.ca)

For more information, please contact Dyaco Canada Inc.

T: 1-888-707-1880 | 5955 Don Murie St., Niagara Falls, Ontario L2G 0A9 | [sales@dyaco.ca](mailto:sales@dyaco.ca)

Dyaco Canada Inc. [dyaco.ca](http://dyaco.ca)