



**INSTRUCTIONS D'ASSEMBLAGE**  
**ASSEMBLY INSTRUCTIONS**

---

**M**ONARCH  
SPECIALTIES INC.

**I 3782**

---

**TABLE DE SALON -**  
**40"L / GRIS / METAL NOIR**

**COFFEE TABLE -**  
**40"L / GREY / BLACK METAL**





**POUR DE L'ASSISTANCE OU POUR COMMANDER  
DES PIÈCES CONTACTEZ NOTRE DÉPARTEMENT  
DE SERVICE À LA CLIENTÈLE.**

**FOR ASSISTANCE OR TO ORDER PARTS  
CONTACT OUR CUSTOMER SERVICE DEPARTMENT**

**WWW.MONARCHSERVICE.COM**

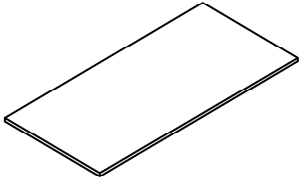
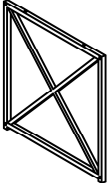
**LISTE DES PIÈCES**  
**PARTS LIST**

PIÈCE / PART #	IMAGE	DESCRIPTION	QTY / QTÉ
1		<p align="center">TABLE TOP SURFACE DE TABLE</p>	1
2		<p align="center">METAL LEG PATTE EN METAL</p>	2
3		<p align="center">CONNECTOR CONNECTEUR</p>	2
4		<p align="center">CONNECTOR CONNECTEUR</p>	2

**LISTE DES PIÈCES DE MONTAGE**  
**HARDWARE LIST**

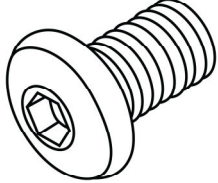
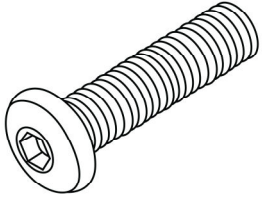
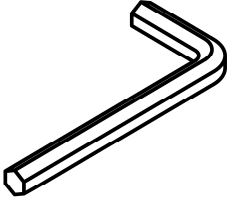
PIÈCE / PART #	IMAGE	DESCRIPTION	QTY / QTÉ
A		<p>ASSEMBLING BOLT - Ø1/4" X 1 1/8"</p> <p>BOULON D'ASSEMBLAGE - Ø1/4" X 1 1/8"</p>	6
B		<p>ASSEMBLING BOLT - Ø1/4" X 1 3/8"</p> <p>BOULON D'ASSEMBLAGE - Ø1/4" X 1 3/8"</p>	8
C		<p>HEX KEY</p> <p>CLÉ HEXAGONALE</p>	1



OUTIL DE VÉRIFICATION DE DIMENSIONS DES PIÈCES  
HARDWARE DIMENSIONS VERIFICATION TOOL



ÉTAPE / STEP 1

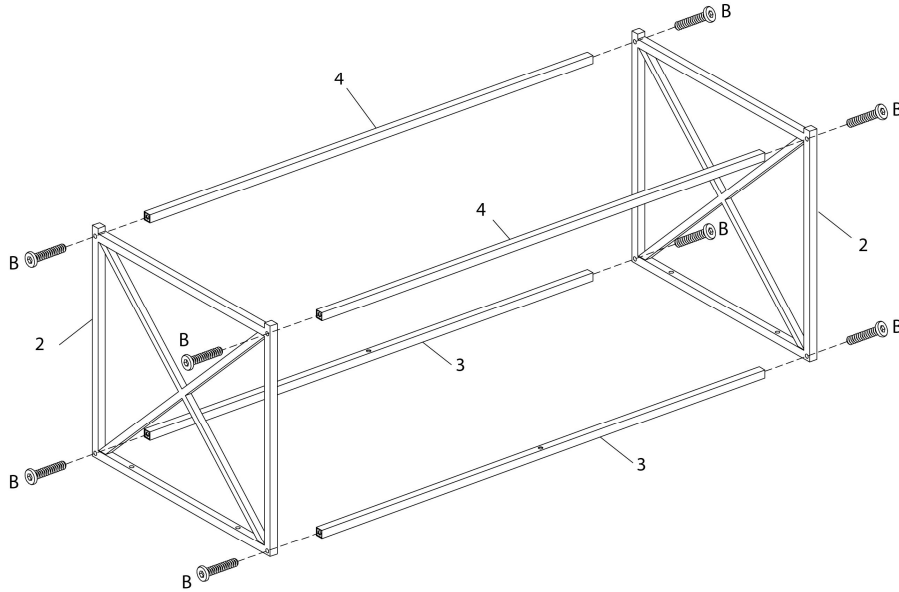

ÉTAPE / STEP 2

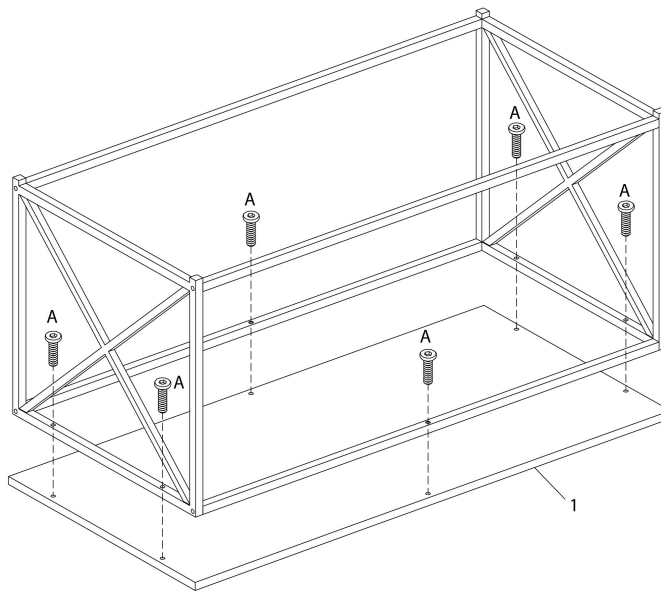

ÉTAPE / STEP 3

