

TYPE SIX ASSEMBLY

Steps to Complete Your Faucet Install

Applicable for the following Wall-mount faucet series:

NBF-W02

NBF-W03

NBF-W04

Please Note:

- Review and abide by all building and plumbing codes
- Standard codes for Novatto faucets: cUPC/CSA/AB1953
- Novatto faucets need to be installed by a professional
- In most cases, there is no need to disassemble handle plate, cover or handle before attaching to body
- Make sure no silt or debris is in water pipes prior to install

- **We recommend consulting a professional** if you are unfamiliar with installing wall mounted bathroom fixtures and plumbing. For the following installation instructions, it is assumed the water is turned off at the source, old fixtures have been removed, water supply lines have been relocated to the proper installation location, the wall studs are exposed and your professional has installed wood blocking between the two studs where the faucet will mount.*

* **Important:** Take into consideration the thickness of your finished wall materials. If the concealed body/valve is installed too far behind your finished wall, you may be left with insufficient clearance to attach the spout and handles.

- **The installation position** and height of the main body, can be determined according to your own needs. Make sure you have enough area created behind the wall in order to secure the rough-in valve. Use the dimensions of the faucet for proper sizing of wall opening. You will have three open areas: the main body conceal area, as well as the cold water and hot water pipe areas.*

* **Important:** Remember, the higher you place the faucet the more difficult it is to control where the water goes when turned on, and the more likely it is to splash. Too low and you're banging your hands against the sink.

- **Remove the spout** and rotate handle plate to remove handle sections from the valve.

- **Mount the rough-in valve** into its prepared location in the wall, water inlets pointing down. Attach the valve body to the wood blocking using *galvanized pipe clamps (*NOT provided). Use a level to ensure that the valve is mounted straight. Connect *main water lines (*NOT provided) to the valve. Apply thread sealant or plumber's tape to the threaded connection to ensure a watertight seal.

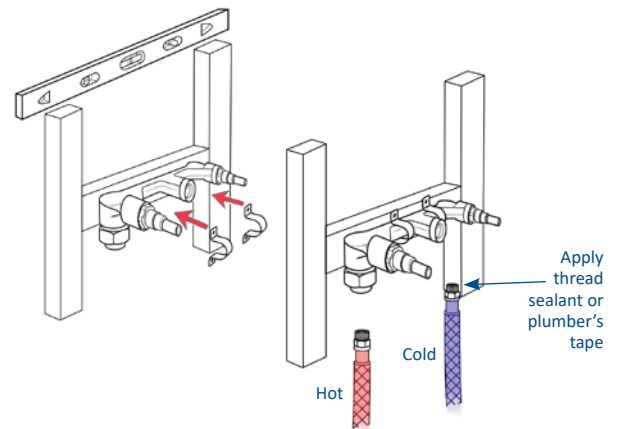
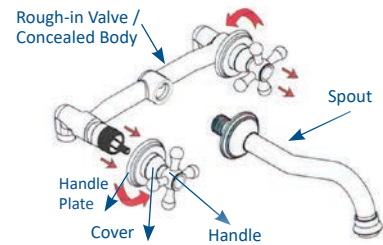
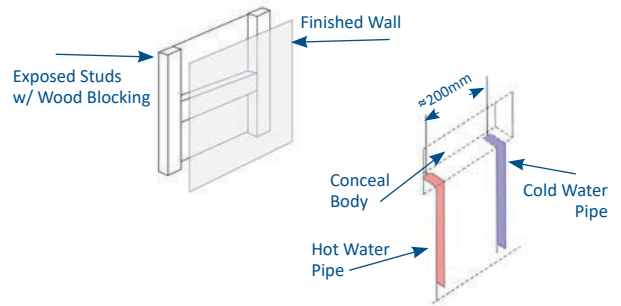

TROUBLESHOOTING TIPS

Issue	Reason	Solution
Need to access plumbing lines	Hot/cold lines connected incorrectly	Ask your plumber to install an access panel in case you need to get in there
Leaking from under the handle	Dirt and debris collected in the valve/cartridge	Blow out pipe/hoses; Might have to replace the valve/cartridge
Finish is changing color or is shiny	Abrasive cleaners, soaps or other factors constantly in contact with it.	Stop using abrasives; Replace parts
Low Water Pressure/Flow	Shut-off valves not open all the way; Debris or air pockets in pipes	Check the shut-off valves, must be open all the way; Blow out pipe/hoses

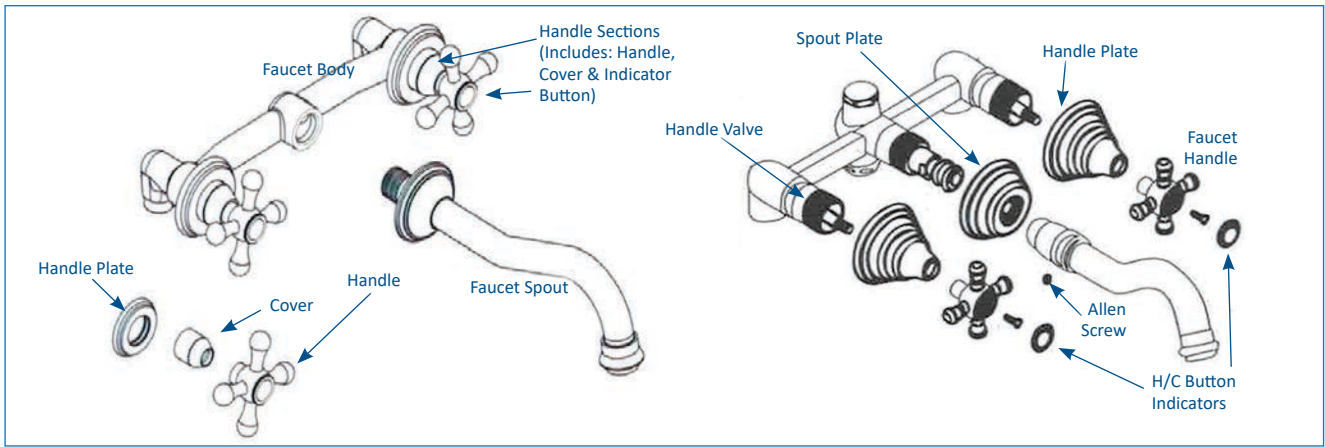

- **Turn on water at main source** to confirm there are no leaks. Make any adjustments now. **STOP!***

* **Important:** COMPLETE THE CONSTRUCTION OF YOUR WALL, INCLUDING ANY FINISHED WALL MATERIALS SUCH AS TILE, BEFORE PROCEEDING WITH THE REMAINDER OF THE INSTALLATION. **STOP!***

* **Important:** Take into consideration the thickness of the finished wall materials. If the rough-in is installed too far behind your finished wall, you may be left with insufficient clearance to attach the spout and handles.

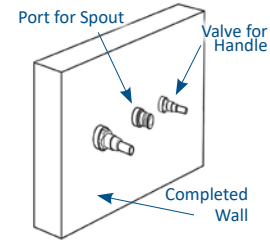

- **Once the finished wall has been completed,** rotate and attach the handle plates and sections back onto the handle valve until they sit tight against the wall. (Do not over tighten as you could cause damage to the wall.) You may have to tighten screws, located under water indicator buttons.

- **Apply plumber's tape** to the threaded connection on the end of the spout. Then twist the spout into the spout connection. Making sure it is level and straight, with spout pointing down.

- **When installation is complete,** turn the faucet handles wide open, then slowly turn the main water supply lines, hot and cold, to their full open position. Allow faucet to run for a couple minutes in order for any dust or loose sediment to clear the system. Verify hot and cold water are running properly by turning off the hot water, allowing only cold to run and vice versa.

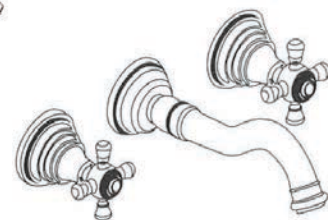
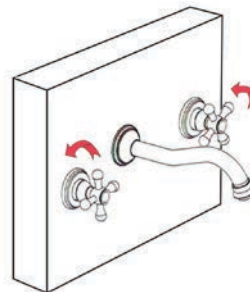
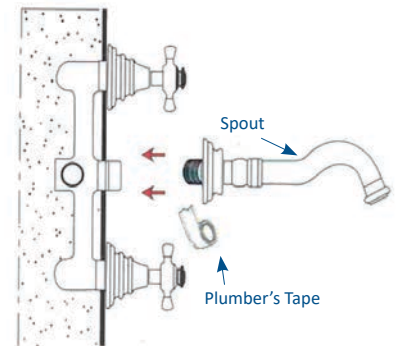
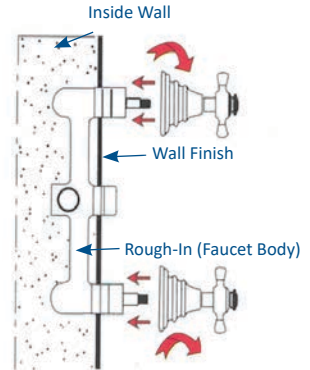

TOOLS NEEDED FOR ASSEMBLY (not included)

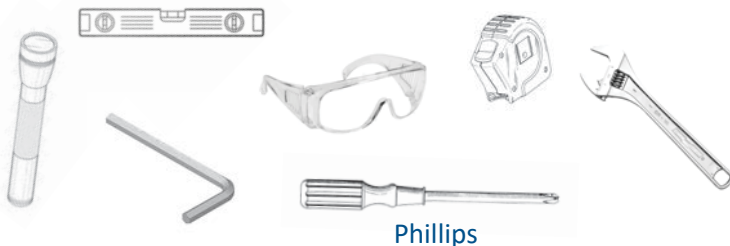

Questions, problems, missing parts? Before returning to your retailer, call our customer service department at 844.404.4242, 8:00 a.m. - 5 p.m., MT, Monday - Friday or email us at: support@novattoinc.com