

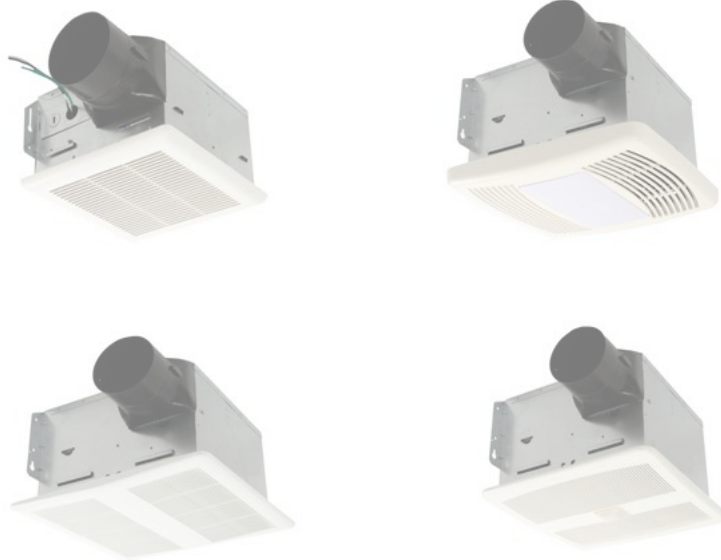

Bathroom Exhaust Fan

Models:



Installation and Operation Instructions

Please read all instructions before installing and operating.

All wiring and installation must be in accordance with CEC, NEC and local electrical codes.

READ AND SAVE THESE INSTRUCTIONS



IMPORTANT SAFETY INSTRUCTIONS



WARNING

TO REDUCE THE RISK OF FIRE, ELECTRIC SHOCK, OR INJURY TO PERSONS, OBSERVE THE FOLLOWING:

- a). Use this unit only in the manner intended by the manufacturer. If you have questions, contact the manufacturer.
- b). Before servicing or cleaning unit, switch power off at service panel and lock the service disconnecting means to prevent power from being switching on accidentally. When the service disconnecting means cannot be locked, securely fasten a prominent warning device, such as a tag, to the service panel.
- c). Installation work and electrical wiring must be done by a qualified person(s) in accordance with all applicable codes and standards, including fire-rated construction codes and standards.
- d). Sufficient air is needed for proper combustion and exhausting of gases through the flue (chimney) of fuel burning equipment to prevent backdrafting. Follow the heating equipment manufacturer's guideline and safety standards such as those published by the National Fire Protection Association (NFPA), and the American Society for Heating, Refrigeration and Air Conditioning Engineers (ASHRAE), and the local code authorities.
- e). When cutting or drilling into wall or ceiling, do not damage electrical wiring and other hidden utilities.
- f). Ducted fans must always be vented to the outdoors.
- g). Acceptable for use over a tub or shower when connected to a GFCI (Ground Fault Circuit Interrupter) - protected branch circuit (ceiling installation only).
- h). This unit must be grounded.
- i). Not for use in kitchens.
- j). To reduce risk of fire and to properly exhaust air, be sure to duct air outside – Do not vent exhaust air into spaces within walls or ceilings or into attics, crawl spaces, or garages.
- k). **WARNING:** To Reduce The Risk Of Fire Or Electric Shock, Do Not Use This Fan With Any Solid-State Speed Control Device.
- l). The fan must not be installed in a ceiling thermally insulated to a value greater R40.



CAUTION

- Do not use for cooking ventilation.
- For general ventilating use only. Do not use to exhaust hazardous or explosive materials and vapors.
- This product is designed for installation in ceilings up to a 12/12 pitch (45 degree angle). Duct connector must point up. This product can be installed in a wall if mounted 8 feet or more above the floor.
- To avoid motor bearing damage and noisy and/or unbalanced impellers, keep drywall spray, construction dust, etc. off power unit.
- Please read specification label on product for further information and requirements.
*The manual in electronic format can be download from our company web, or obtained from our dealer.

BATH FAN INSTALLATION - TOOLS AND MATERIALS REQUIRED

- Electrical drill or ratchet driver
- ½” drill bit for drilling pilot holes
- 1 ¼” drill bit for drilling electrical wiring access hole (if applicable)
- Phillips screwdriver #2 or driver bit
- Wire stripper or cutter
- Aluminum foil tape and/or duct tape
- Electrical supplies for wiring (i.e. marrets, electrical tape)

PARTS SUPPLIED

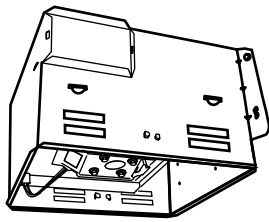

1 × Fan

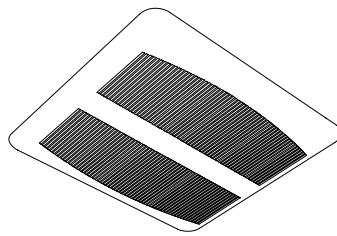

1 × Grille Assembly
(Includes 2 × Grill Spring)

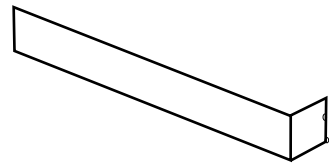

4 × Mounting Bracket

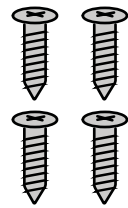

4 × Flange Screws

PLAN THE INSTALLATION

1. Do not use in a cooking area.
2. Two ways to connect ductwork to a factory-shipped unit.

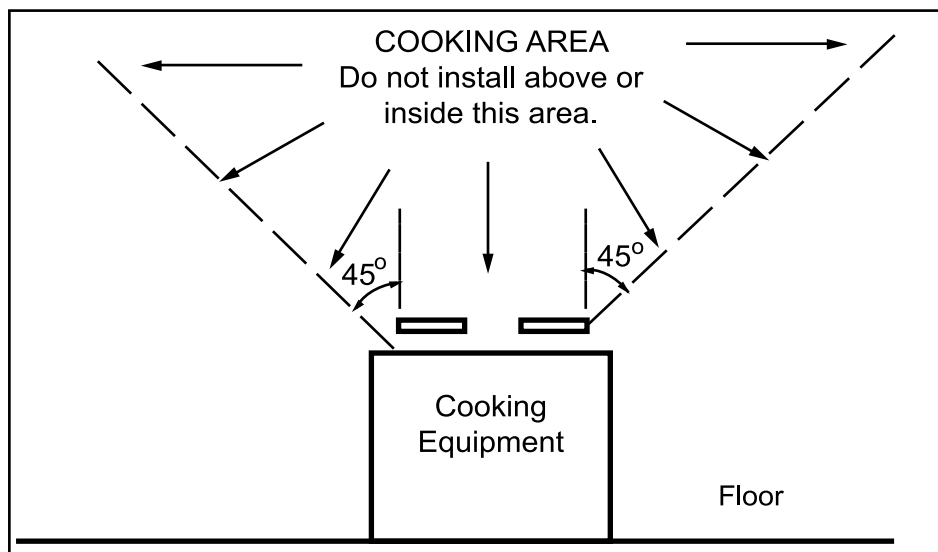

DO NOT MOUNT OVER COOKING AREA

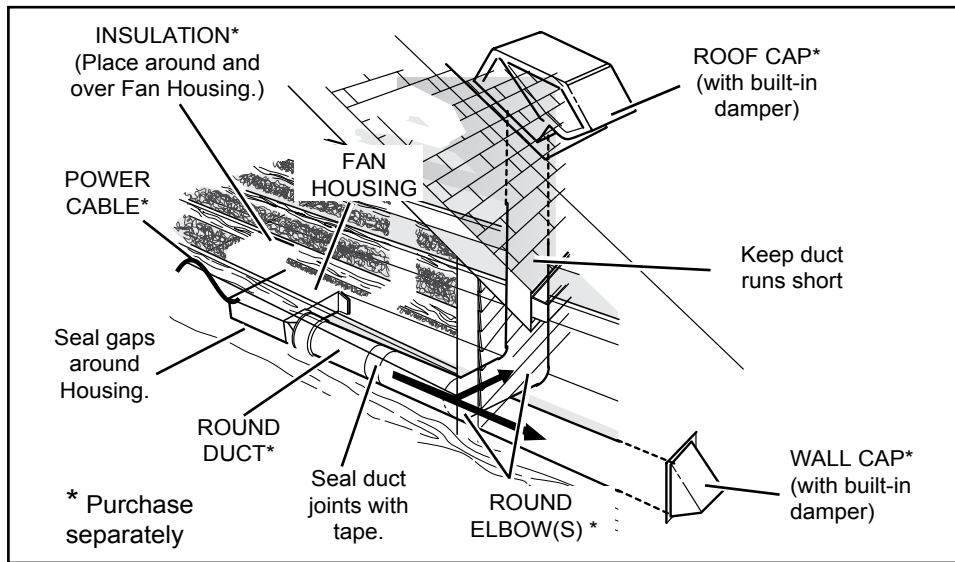

ROOF EXHAUST OR SIDE WALL EXHAUST

Note: For best performance, use the shortest, straightest duct routing possible and avoid installing with smaller ducts than suggested.

INSTALLATION STEPS

1. REMOVE PACKAGING AND SWITCH OFF POWER

2. THREE TYPES OF TYPICAL MOUNTING

- a) For housing mounted to I-joists (Begin at "FOR JOIST OR I-JOIST MOUNTING")
- b) For housing mounted to joists (Begin at "FOR HANGER BARS MOUNTING")
- c) For housing mounted to truss (Begin at "FOR TRUSS MOUNTING")

FOR JOIST OR I-JOIST MOUNTING

Step 1: Hold the housing so that it is in contact with the bottom of the joist. Attach the housing with four (4) screws to the joist through the holes in each mounting flange.

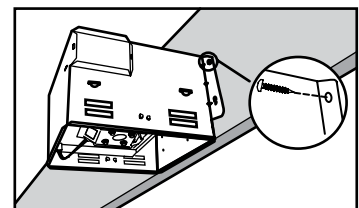

FOR HANGER BARS MOUNTING

Step 1: Sliding hanger bars have been provided, which allow the housing to be positioned accurately anywhere between the framing. The bars span up to 24 inches and can be used on all types of framing: I-joist, standard joist, and truss construction. Slide hanger bars onto housing and adjust as needed to fit between framing.

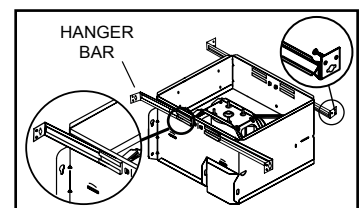

Step 2: Extend the hanger bars to the width of the framing. Position the ventilator with the hanger bar tabs wrapped around the bottom edge of the framing, holding the ventilator in place.

Step 3: Secure hanger bars to framing using one screw on each end of hanger bar. Select a proper hole and secure the hanger bars together using the flange screws(provided).

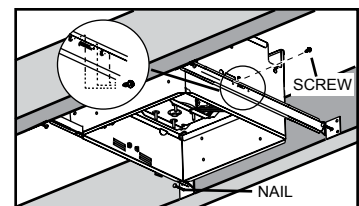

FOR TRUSS MOUNTING

Step 1: Snap the damper/duct connector onto the fan housing. The connector must be flush with the top of the housing, and the damper flap should fall closed.

Optional: Insulated flexible duct is recommended for the quietest possible installation. If rigid duct is used, a short (1-3 feet) section of insulated flexible duct will ensure quiet operation.

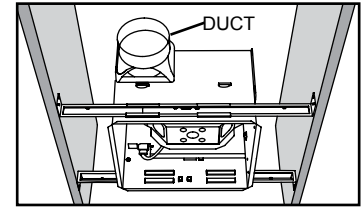

* FOR MODEL CB50, PLEASE READ ADDITIONAL STEPS

Snap-in and secure housing.

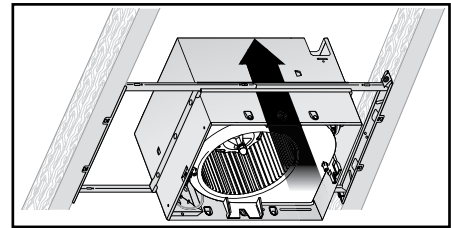

3. INSTALL ROUND DUCTWORK

Step 1: Connect the round ductwork (not included) to the damper/duct connector, and run the ductwork to a roof or wall cap (not included).

Step 2: Using aluminum tape (not included), secure all the ductwork connections so that they are air tight.

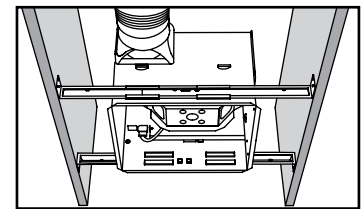

4. CONNECT ELECTRICAL WIRING

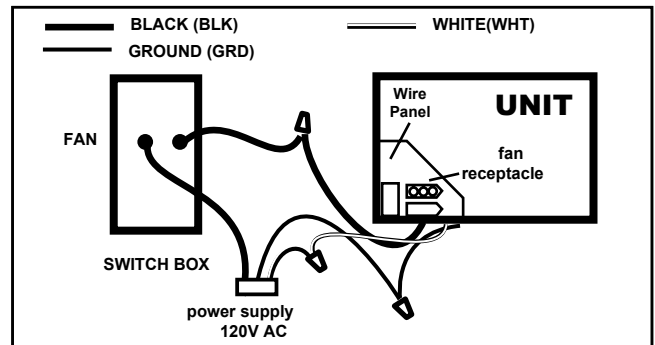
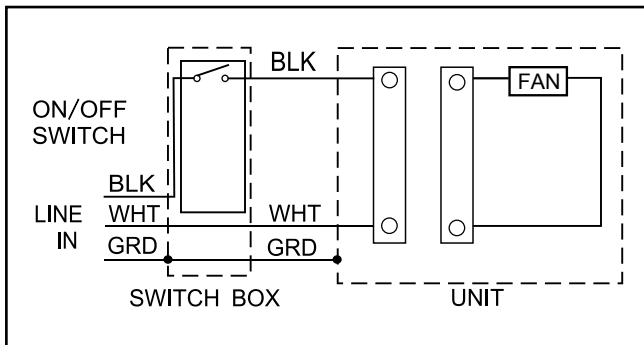

- Run 120 V AC house wiring to the location of the fan. Use only UL-approved connectors (not included) to attach the house wiring to the wiring plate. Refer to the wiring diagram, and connect the wires as shown.

INSTALL GRILLE

Step 1: Install ceiling material to complete the ceiling construction. Then, cut around the fan housing.

Step 2: To attach the grille assembly to the fan housing, pinch the grille springs on the sides of the grille assembly, and position the grille into the housing with the grille springs in the appropriate slots.

Step 3: Push the grille assembly towards the ceiling to secure.

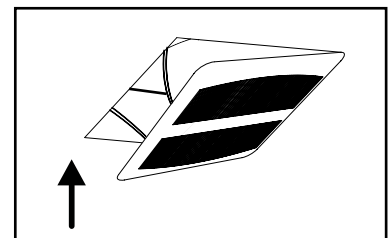

OPERATION

Use an on/off switch to operate this fan. See “Connect Wiring” for details.

CLEANING & MAINTENANCE

For quiet and efficient operation, long life, and attractive appearance - lower or remove grille and vacuum interior of unit with the dusting brush attachment. The motor is permanently lubricated and never needs oiling. If the motor bearings are making excessive or unusual noises, replace the motor with the exact service motor. The impeller should also be replaced.

SERVICE PARTS

WARNING: Ensure that the fan is switched off from the supply mains before replacing.

PART	PART NAME	Qty.
1	GRILLE	1
2	SPRING	2
3	MOTOR ASSEMBLY	1
4	MOTOR	1
5	BLOWER WHEEL	1
6	WIRE PANEL ASSEMBLY	1
7	WIRE COVER	1
8	HOUSING	1
9	HANGER BARS	4
10	DUCT CONNECTOR	1
a	NUTS	4
b	GROMMETS	4
c	MOTOR BRACKETS	1
d	MOTOR MOUNTING PLATE	4
e	SCREWS	1

* Blower Assembly includes part 5, 4, d, 3, c, b, a.

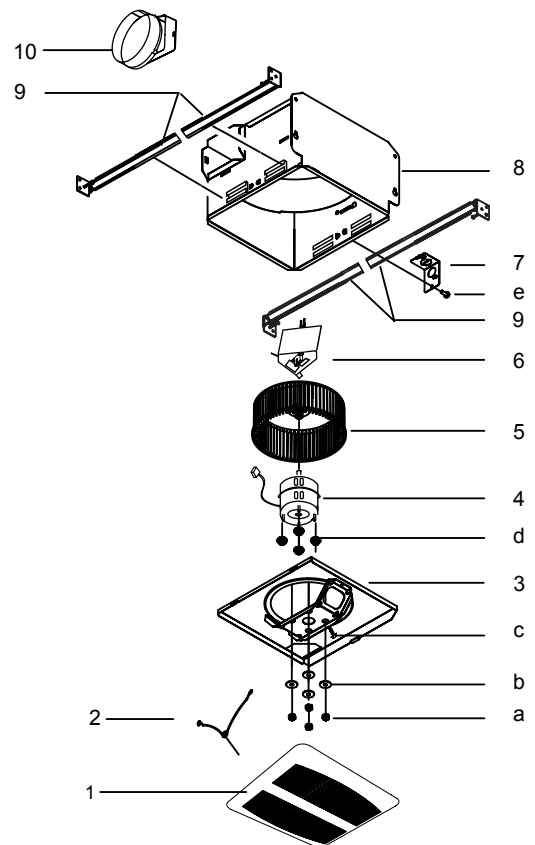

Replacement installation:

Remove the screw (part c), then take out the motor plate (part 3) from the housing (part 8) by pushing down the rib in the plate while pulling out on the side of the housing. Replace the broken parts.

TROUBLESHOOTING

For additional service inquiries, contact Cyclone servicing department at 1-888-293-5662 or Service@CycloneRangeHoods.com

ISSUE	CAUSE	SOLUTION
Unit does not work after installation.	1. The power source is not turned ON.	A. Ensure power is ON for the circuit breaker and unit.
		B. Check for an open fuse or circuit breaker in the building's service panel.
Light indicates power ON but motor doesn't turn.	1. Plug-in connections for motor may be loose.	1. Check that the two plug-in connections for the motor and the control are seated firmly in place.
	2. Motor wiring may be damaged.	2. Change the motor. Servicing may be required.
	3. The motor is not secured.	3. Tighten the motor in place.
	4. Damaged blower wheel.	4. Replace the blower wheel. Servicing may be required.
	5. Blower wheel assembly may be loose.	5. Check that the blower wheel is firmly attached to the motor shaft and both spin freely.
Motor works but lights do not turn on.	1. The light bulb is loose.	1. Tighten the light bulb.
The unit vibrates.	1. Damper in duct connector may be blocked.	1. Check that the back draft damper in the fan's duct connector pivots freely. Screws used to attached the duct to the duct connector may be preventing the damper from opening
	2. Damper may be blocked or sealed shut.	2. Check that the back draft damper in the wall or roof cap pivots freely. These dampers are sometimes mistakenly painted shut or obstructed by bird and insect debris.
	3. Venting duct too small or blockage in the duct opening or ductwork.	3. Check the venting duct and the wall cap or roof cap.
Bath fan is not venting out properly.	1. Used the wrong size of ducting.	1. Use 6" duct work for best results.

CYCLONE BATHROOM EXHAUST FAN LIMITED WARRANTY

North America Range Hoods Inc. (hereunder called “The Company”) provides a warranty that its products are free from defects in workmanship and materials for a period of one (1) year from the date of purchase for the following models: C50, C80, CB50, CB80 and for a period of three years for the following models: ESCB80 (H/L/S/HL/HM/SL/SM), ESCB110 (H/L/S/HL/HM/SL/SM), CBD120 (H/L/S/HL/HM/SL/SM), ESCB150(H/L/S/HL/HM/SL/SM). During that time period, The Company will, at the Company’s option, repair or replace, without charge, any parts or complete unit found to be defective. This warranty is not transferable from the original purchaser. The company reserves the right to use functionally equivalent reconditioned parts or products as warranty replacement or as part of warranty service. Warranty does not cover the costs of removal, installation and/or transportation of defective products.

THE COMPANY WILL NOT BE HELD RESPONSIBLE FOR ANY CLAIMS OVER THE ORIGINAL PURCHASE PRICE OF THE PRODUCTS NOR BE LIABLE FOR INCIDENTAL, CONSEQUENTIAL OR SPECIAL DAMAGES ARISING OUT OF OR IN CONNECTION WITH PRODUCT USE OR PERFORMANCE.

Some provinces/states do not allow the exclusion or limitation of incidental or consequential damages, so the above limitation or exclusion may not apply to you.

The unit removal and re-installation works are under the customer responsibility.

This warranty does not cover any costs related to the products including but not limited to:

a) Normal maintenance service required for the products; b) light bulbs, grill covers, adapters and other accessories for ducting; c) natural wear of the finish of the products or wear caused by improper maintenance, use of corrosive and abrasive cleaning products; d) products or parts which have been subject to freight damage, misuse, negligence, accident or any other circumstances beyond the control of The Company. e) In addition, this warranty does not apply to the following items:

- Damage or loss sustained in natural calamity such as fire, earthquake, flood, thunder, electrical storm, etc.
- Damage or loss resulting from any unreasonable use, misuse, abuse, negligence, or improper maintenance of the product.
- Damage or loss resulting from removal, improper repair, or modification of the product.
- Damage or loss resulting from sediments or foreign matter contained in a water system.
- Damage or loss resulting from improper installation or from installation of a unit in a harsh and/or hazardous environment.
- Acts of God or any circumstances beyond The Company.

The warranty will be automatically void if any of the following apply:

- i. Used for cooking ventilation;
- ii. Commercial use of the products or use otherwise inconsistent with its intended purpose;
- iii. The function of part or the complete assembly has been modified or repaired by unauthorized person;
- iv. Faulty installation or installation contrary to recommended installation instructions;
- v. **Ventilation system has not been vented to the outside or ventilation system stuck;**
- vi. **The venting duct turned downward anywhere in the venting system;**
- vii. **Wrong electrical wire connection for the fan.**

To qualify for warranty service you must: (a) notify us at the address and telephone number, stated below within 2 days of the discovery of the defect; (b) provide the model number and serial number; and (c) describe the nature of any defect in the product or part. At the time of requesting for service, you must present evidence of your proof of purchase and proof of the original purchase date. If we determine that the warranty exclusions listed above apply or if you fail to provide the necessary documentation to obtain service, customer will be responsible for all shipping, travel, labor and other costs related to the service.

Warning! The Company will not be responsible for any defects caused by kitchen installation applications. This Product is not intended for kitchen exhaust applications.

For warranty services or repair, please contact the dealer from whom you purchased the product or the address shown below.

North America Range Hoods Inc.
Canada: 1361 Huntingwood Drive, Unit 16, Scarborough, ON M1S 3J1
USA: 64 Salem Street, Medford, MA 02155
Tel: 1-888-293-5662 or (416) 293-0933 Fax (416) 293-4793
Email: Info@CycloneRangeHoods.com
Website: www.CycloneRangeHoods.com