

ITEM NO.	PART NUMBER	DESCRIPTION	QTY.
1	PIPE-FL38-3	3/8" FLANGE	2
2	PIPE-EL38-90	3/8" 90 DEG. ELBOW	2
3	PIPE-CAP-38	3/8" CAP	2
4	PIPE-NIP38-2.5	3/8" 2 1/2" NIP	2
5	PIPE-TEE-38	3/8" TEE	2
6	PIPE-CU-38	3/8" CUPLING	2
7	TU34-4	3/4" TUBE 4"	4
8	TU34-20	3/4" TUBE 20"	1
9	BUS-38X18	3/8" BUSHING	14
10	CRRD2-34	3/4" DOUBLE CK RING	10
11	IRWRT-22	IPE SHELF 22"	2
12	WOOD SCREW-12	#12 WOOD SCREW	8

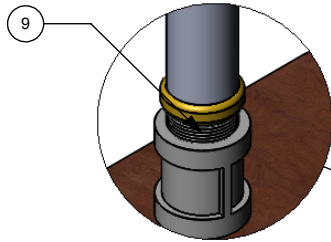

DETAIL AA
SCALE 1:2

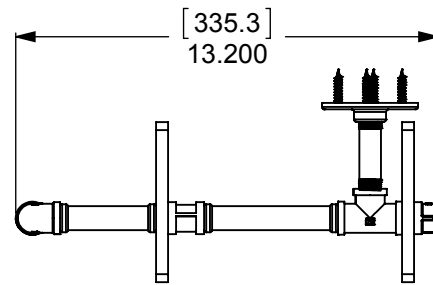
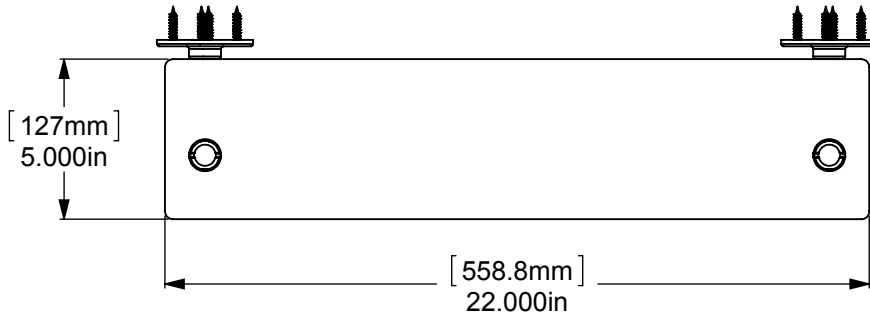
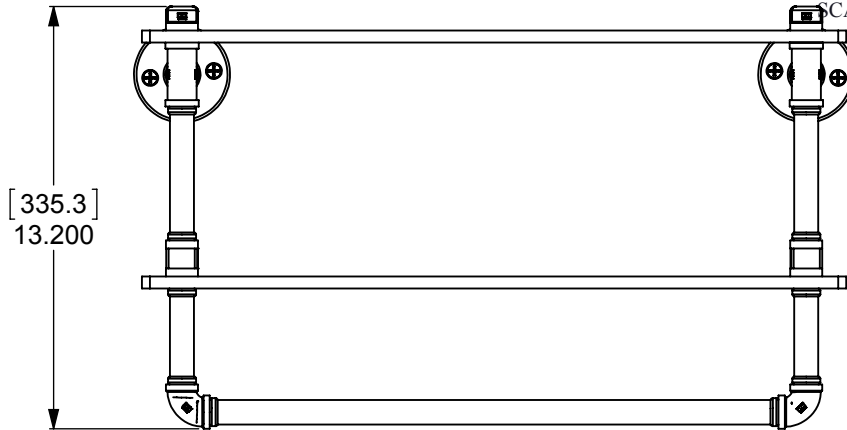
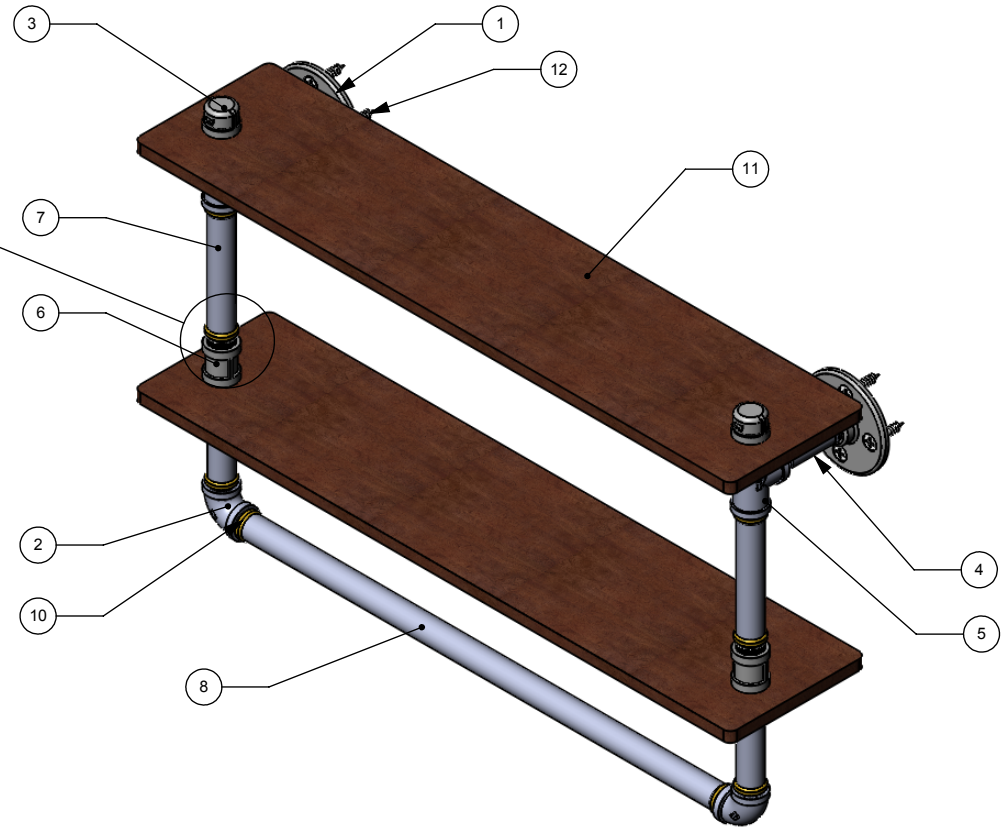

APPROVED FOR PRODUCTION

BY: RICHARD PAUL
DATE: 6/8/2017

UNLESS OTHERWISE STATED

.X	±.3mm
.XX	±.15mm
.XXX	±.008mm

COPYRIGHT © Allied Brass 2017

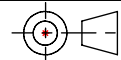

THIRD ANGLE PROJECTION

DRAWN	6/7/2017	I.M	MATERIAL:	BRASS	FINISH	TBD
CHECKED	6/7/2017	P.D	DESCRIPTION:		QUANTITY	TBD
APPROVED	6/7/2017	R.A	Pipeline Collection Double IPE Shelf with Towel Bar		DRAWING No.	REV
					P-480-22-DWSTB	0
				SCALE	1:6	SHEET: 01 A4