

5 Set the upper tray and lid on top and let the worms get accustomed to their new home.

NOTE: always store your farm in a cool dark location.

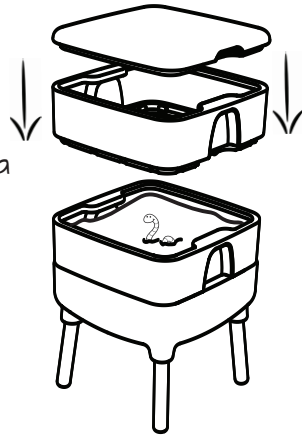

'Day Two'



6. 'Feeding Day', start feeding your worms (see page 1 for list of suitable worm food)

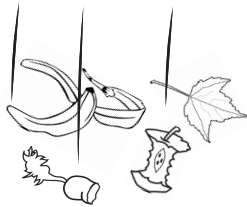

repeat step 2 & 3 →

make sure holes in contact with soil below →

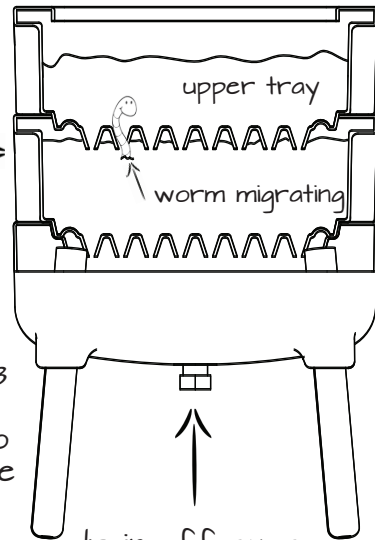

↑
drain off excess moisture here

7 After several weeks the worms have done their work, and it's time to fill the 'upper tray'. repeat previous steps 2 & 3 then add 'food'. Your worms will migrate into the upper tray and start the process over (replace lid)

www.fcmonline.com

the  **HOTFROG**[®]
OUTDOOR LIVING

'Living Composter'

by FCMP Outdoor

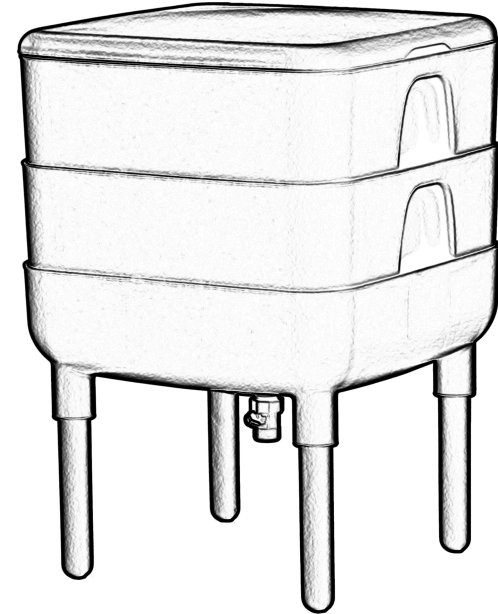

instructions

suitable worm food:

most fruits, vegetables, cereals and grains, organics, cardboard, tea bags.

DON'T FEED US !

bones, meat, dairy products, oils, salty foods, grass clippings, citrus, inorganic products

for more information see: www.fcmonline.com

Copyright © 2018 GRANDMARK Ltd.

'Parts List'

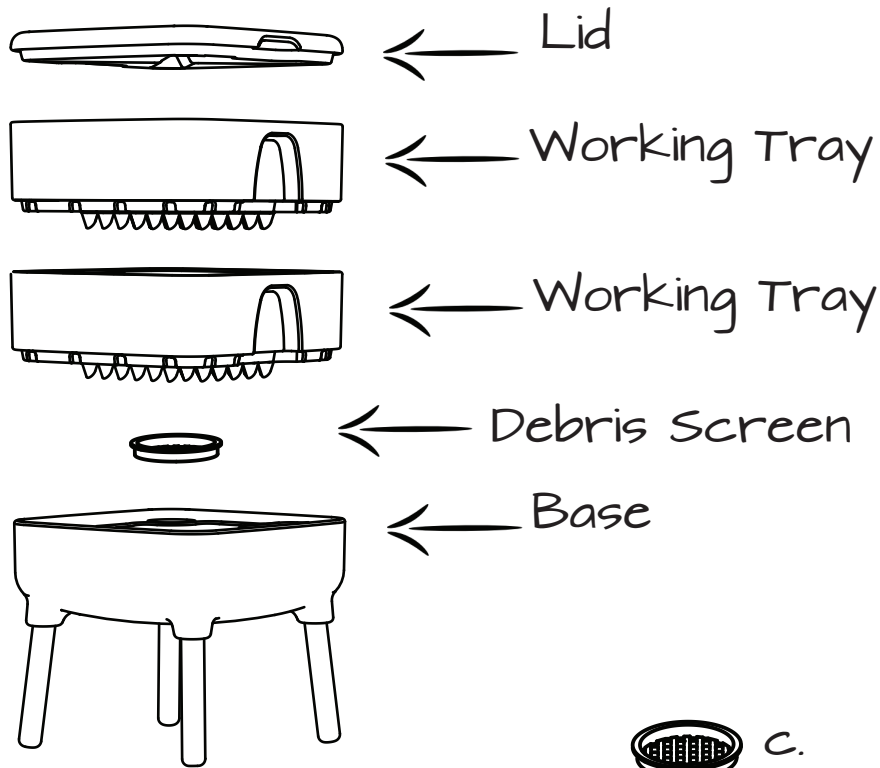

'Assembly'

a. insert legs into corners

b. screw on 'drain valve' into the bottom of base

c. install 'debris screen' into recessed area over 'drain valve'

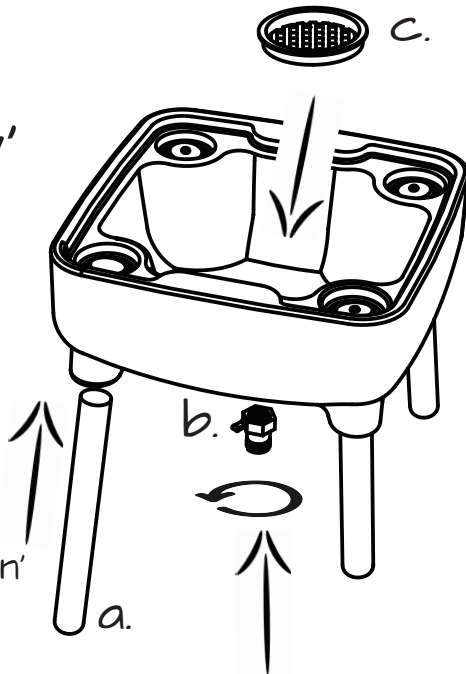

'Day One'

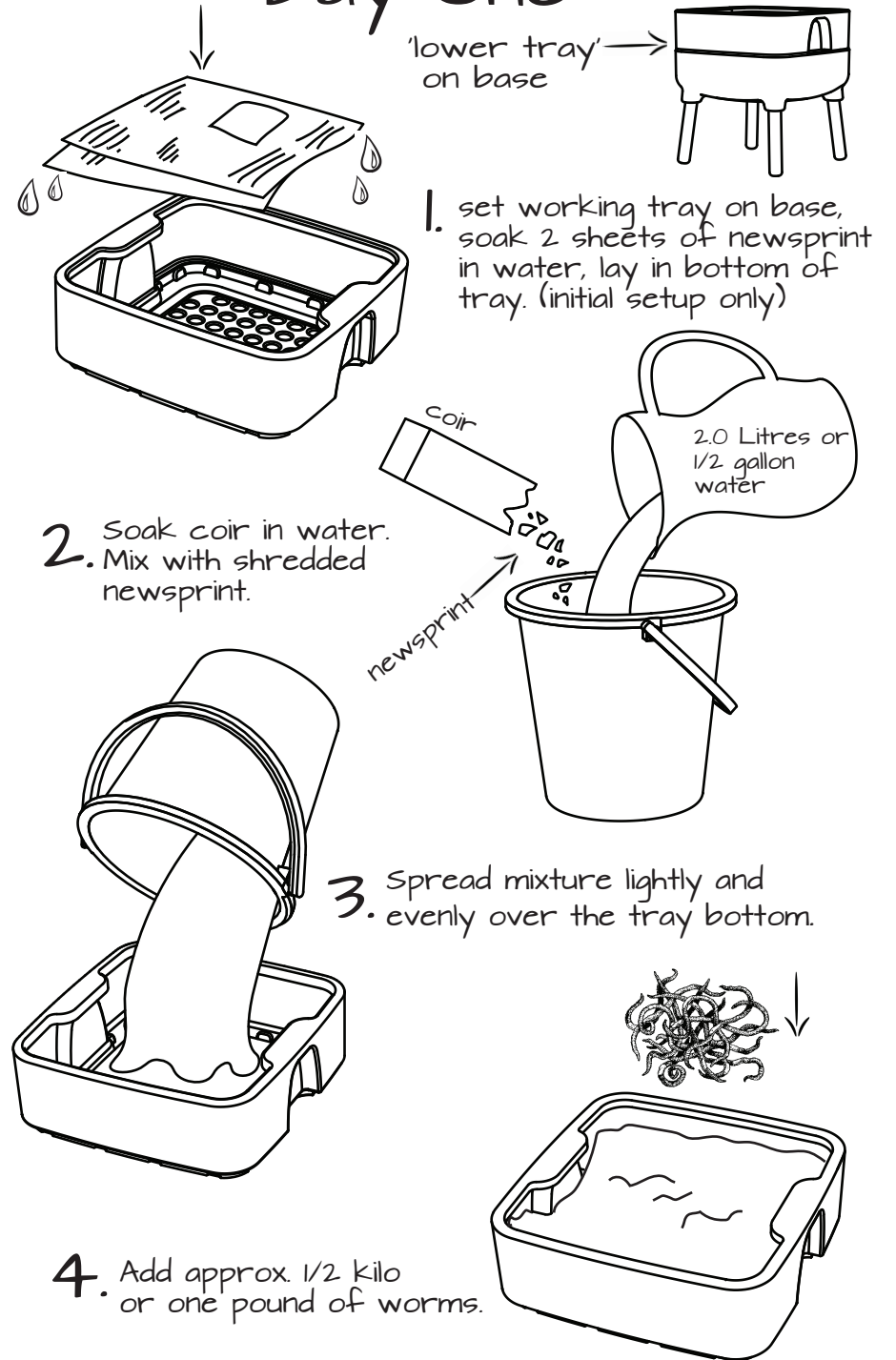

5 Coloca la bandeja superior y la tapa por arriba y deja que las lombrices se acostumbren a su nuevo

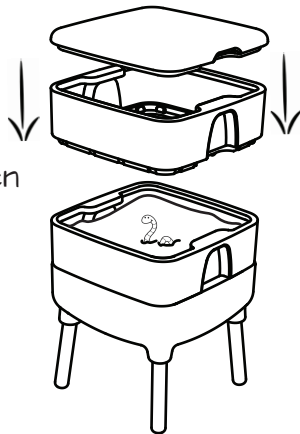

NOTA: Guarda siempre tu granja en un lugar fresco y oscuro

'Día Dos'



6. 'Día de Comida'. Comienza a alimentar tus lombrices (ver en página 1 la lista de comida adecuada para las lombrices).

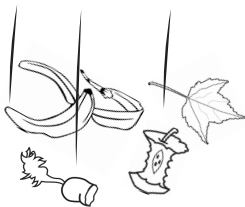

repite los pasos 2 y 3 →

asegúrate de que los orificios están en contacto con la tierra de abajo →

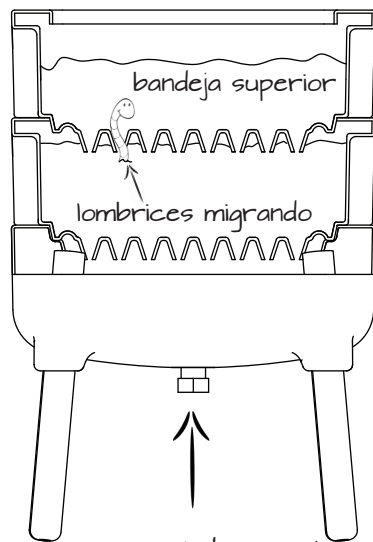

7. Luego de varias semanas, las lombrices habrán hecho su trabajo, y será tiempo de llenar la bandeja superior. Repite los anteriores pasos 2 y 3 y luego agrega 'comida'. Tus lombrices migrarán a la bandeja superior y comenzarán otra vez el proceso (reemplaza la tapa)

www.fcmonline.com

la  **HOTFROG**[®]
OUTDOOR LIVING

'Compostera Viva'

de FCMP Outdoor

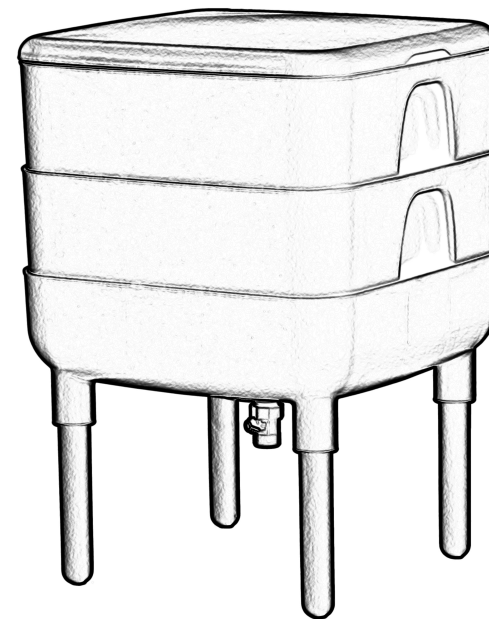

instrucciones

comida adecuada para lombrices:
la mayoría de las frutas, vegetales, cereales y granos, orgánicos, cartón, saquitos de té.

¡NO NOS DES!

huesos, carne, productos lácteos, aceites, comidas saladas, cortes de pasto, cítricos, productos inorgánicos

para mayor información, consulta: www.fcmonline.com

'Lista de Partes'



← Tapa

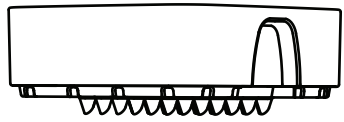

← Bandeja de Trabajo

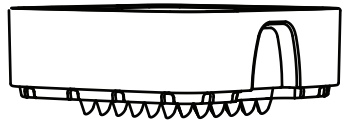

← Bandeja de Trabajo



← Filtro de impurezas

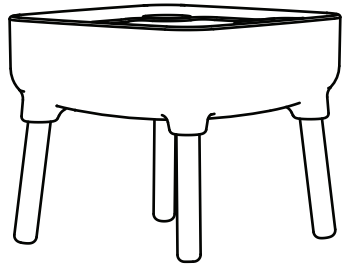

← Base

'Montaje'

a. Insertar las patas de madera en las esquinas de la base

b. enroscar la 'válvula de drenaje' en el fondo de la base

c. instalar el 'filtro de impurezas' en el área encastrada sobre la 'válvula de drenaje'



'Día Uno'

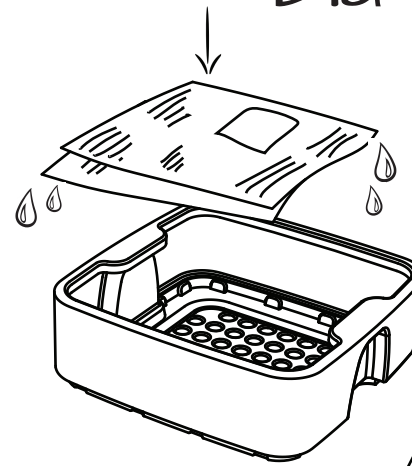

'bandeja inferior' sobre la base

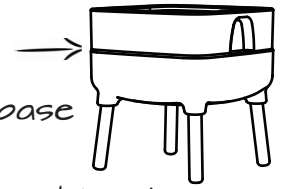

1. Coloca la bandeja sobre la base, sumerge dos hojas de papel de diario en el agua, déjala en el fondo de la bandeja (sólo en la preparación inicial)

2. Sumergir 1/2 ladrillo de coco en el agua. Mezclar con papel de diario picado

ladrillo de coco

2 litros o 1/2 galón de agua

papel de diario

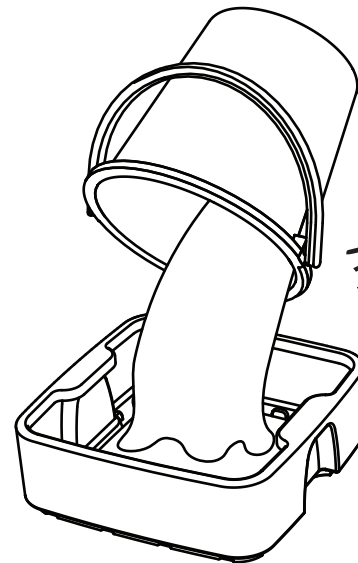

3. Desplegar la mezcla de manera suave y pareja sobre el fondo de la bandeja.



4. Añadir aprox. 1/2 kilo o una libra de lombrices.

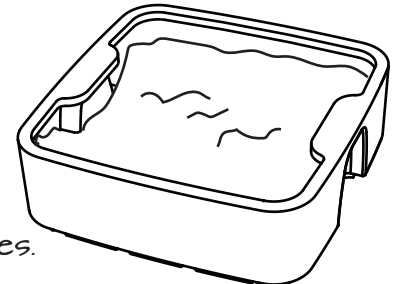

5. Mettez le plateau supérieur et le couvercle sur le dessus et laissez les vers s'habituer à leur nouvelle maison.

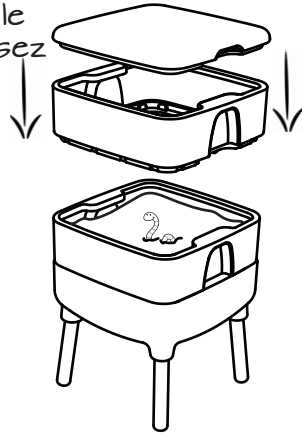

NOTE: Conservez toujours votre ferme à l'écart du soleil direct.

'Jour 2'



6. 'Jour d'alimentation', commencez à nourrir vos vers (voir à la page 1 pour la liste de nourriture appropriée pour les vers).

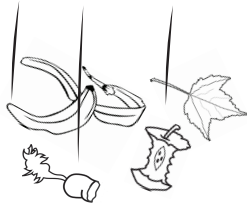

Répétez les étapes 2 et 3. →

Assurez-vous que les trous sont en contact avec le sol en dessous. →

7. Après plusieurs semaines, les vers ont fait leur travail et il est temps de remplir le 'plateau supérieur'. Répétez les étapes 2 et 3, puis ajoutez de la 'nourriture'. Vos vers migreront vers le plateau supérieur et commenceront le processus (remplacez le couvercle).

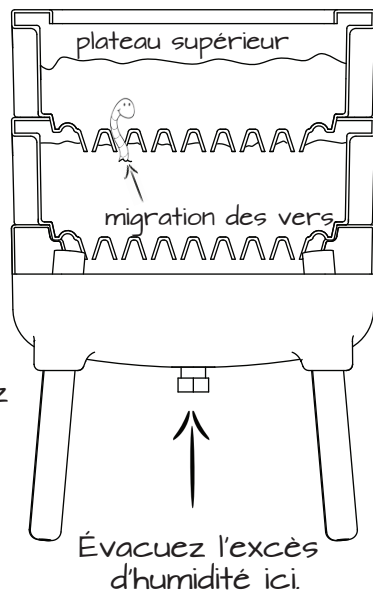

www.fcmonline.com



Le

'composteur vivant'

par FCMP Outdoor

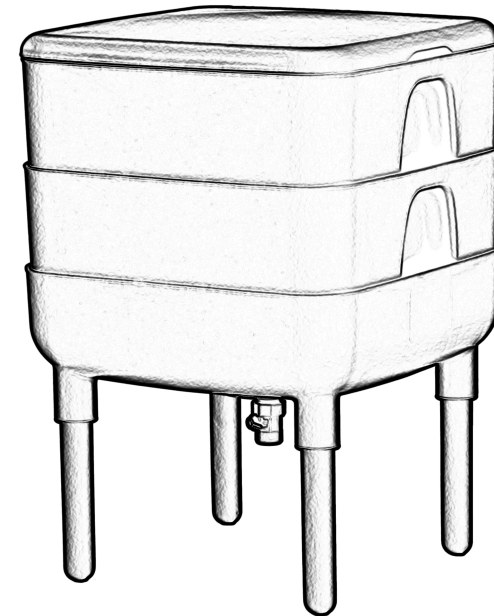

instructions

Nourriture appropriée pour les vers: la plupart des fruits, des légumes, des céréales et des graines, des produits organiques, des papiers cartons, des sachets de thé.

NE NOUS NOURRISSEZ PAS!
d'os, de viandes, de produits laitiers, d'huile, de nourritures salées, de déchets de coupe, d'agrumes, de produits inorganiques.

Pour plus d'informations, visitez le : www.fcmonline.com

«Liste des Différentes Pièces»

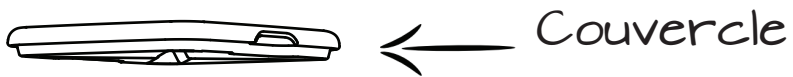

Couvercle

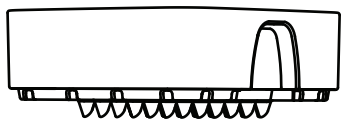

Plateau

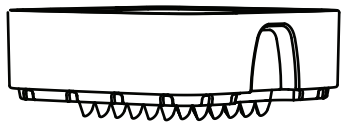

Plateau



Filtre à Débris

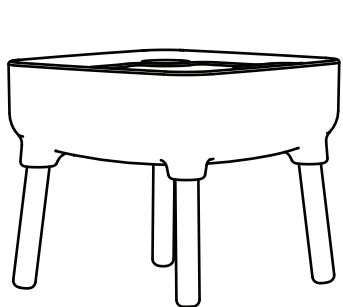

Base

«Assemblage»

a. Insérez les pieds en bois dans les coins de la base

b. Vissez la valve de drainage dans le fond de la base

c. Installez le filtre à débris dans la zone encastrée de la valve de drainage

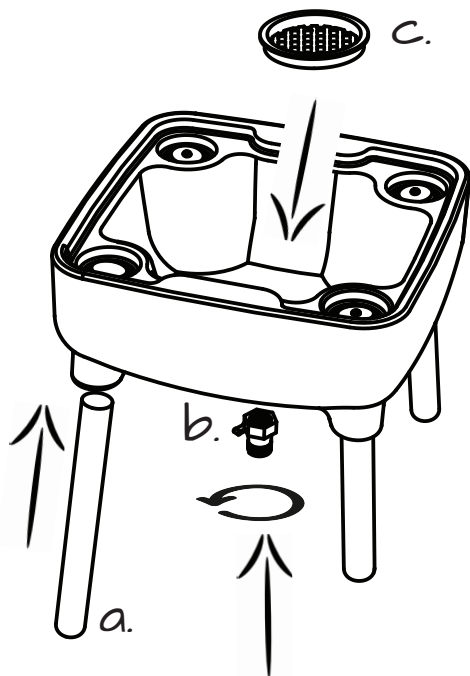

«Premier Jour»

Abaissez le plateau sur la base.

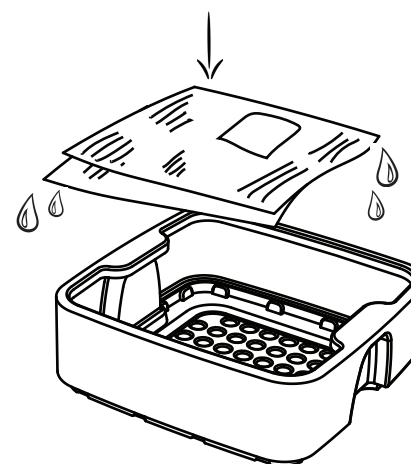

1. Installez le plateau sur la base, imprégnez d'eau 2 feuilles de jour, étalez-les sur le plateau. (Mise en place initiale).

2. Faites tremper de fibres de coco. Mélangez-la à du papier journal déchiqueté.

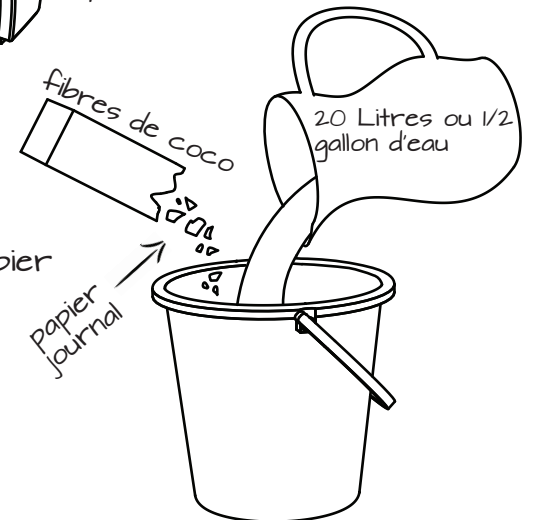

3. Étalez légèrement et uniformément le mélange dans le plateau inférieur.

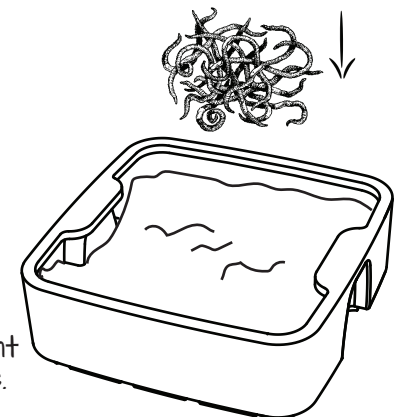
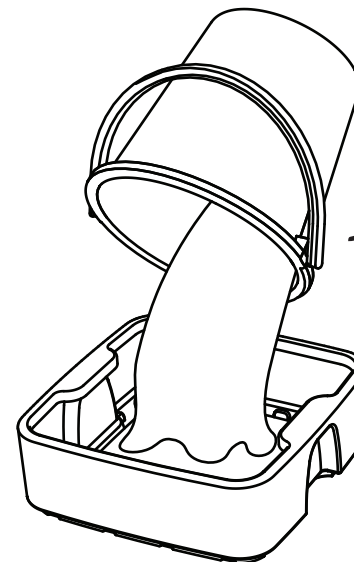

4. Ajoutez approximativement 500 gr ou 1 livre de vers.