

AZUNI®

NANTES C126L

STAINLESS STEEL
HANDMADE SINGLE BOWL KITCHEN SINK



DIMENSIONS

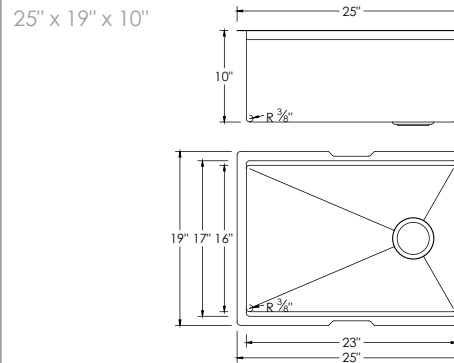

INCLUDED ACCESSORIES

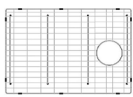

G-126
GRID



ST-03
STRAINER



A-902DG
DRYING RACK



A-906
CUTTING BOARD

RECOMMENDED ACCESSORIES



A-02
COLANDER



A-908
SERVING BOARD



A-912
CUTTING BOARD



S-01S
SOAP DISPENSER

SURFACE FINISH

BRUSHED
SATIN FINISH

DRAIN HOLE SIZE



CORNER PROFILE



RADIUS 10mm

INSULATION

COATED +
RUBBER PADS

BOWL DEPTH

10"
SINGLE
BOWL

SIDE DRAIN HOLE

CABINET
SPACE
SAVER

INSTALLATION OPTIONS



UNDERMOUNT

MATERIAL

Premium 16 gauge stainless steel with 18/10 chrome-nickel content. The 18% of chrome content provides durability, maximum protection against rust and a beautiful satin finish. The 10% of nickel content provides excellent strength and hardness.



16 GAUGE
STAINLESS STEEL

PRODUCT DIMENSIONS

Overall Dimensions	25" x 19" x 10"
Internal Dimensions	23" x 17" x 10"
Left Basin	-
Right Basin	-
Drain Opening Size	3 1/2"

LUXURY BASKET STRAINER

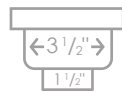

CABINET SIZE

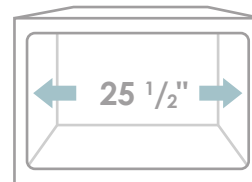

MINIMUM
INTERNAL SIZE

GARBAGE DISPOSAL

AZUNI® sinks have on standard 3 1/2" drain opening that can fit any garbage disposal unit. The sink structure is well designed to withstand any heavy garbage disposal unit.



WARRANTY

This product is covered by a limited lifetime warranty. Consult our website for complete details.

PRODUCT CARE

Rinse and dry your sink with a clean soft cloth, working with, not a cross, the grain. We recommend the use of a mild solution of water and vinegar to remove any mineral deposits that may have built up on your sink.

Use mild non-abrasive liquid cream cleaners that do not contain chlorine, sodium hypochlorite or hydrochloric acid to help maintain the original appearance of your sink. Ensure that you thoroughly rinse your sink and wipe it dry. We recommend the use of a stainless steel grid that fits inside the bottom of the sink bowl and protect the sink from scratches.



STANDARDS COMPLIANCE

cUPC certified
ISO 9001 certified

AZUNI®

NANTES C126L

ÉVIER DE CUISINE À CUVE SIMPLE
FAIT MAIN EN ACIER INOXYDABLE



DIMENSIONS

25" x 19" x 10"

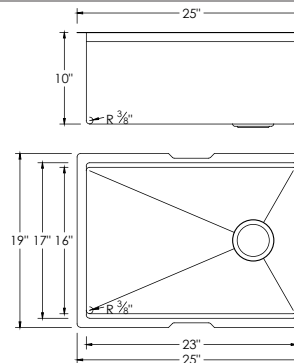

ACCESSOIRES INCLUS

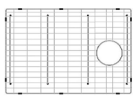

G-126
GRILLE



ST-03
CRÊPINE



A-902DG
SÉCHOIR



A-906
PLANCHE À DÉCOUPER

ACCESSOIRES RECOMMANDÉS



A-02
ÉGOUTTOIR

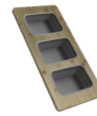

A-908
PLATEAU DE SERVICE



A-912
PLANCHE À DÉCOUPER



S-01S
DISTRIBUTEUR DE SAVON

FINITION DE LA SURFACE

FINI SATINÉ
BROSSÉ

DIMENSION DE L'ORIFICE DU DRAIN



PROFILÉ D'ANGLE



RAYON 10mm

INSULATION

TAMPONS ENROBES
+
EN CAOUTCHOUC

PROFONDEUR DE LA CUVE

10"
CUVE
SIMPLE

CÔTÉ DRAIN TROU

ÉCONOMISEUR
D'ESPACE

OPTIONS D'INSTALLATION



ENCASTRÉ

MATÉRIEL

Acier inoxydable de première qualité de calibre 16 avec teneur en chrome-nickel 18/10. La teneur en chrome de 18 % assure une durabilité, une protection maximale contre la rouille et une belle finition satinée.

La teneur en nickel de 10 % offre une excellente solidité et résistance.



DIMENSIONS DU PRODUIT

Dimensions Hors Tout 25" x 19" x 10"

Dimensions Intérieures 23" x 17" x 10"

Cuve Gauche -

Cuve Droite -

Taille d'ouverture du Drain 3 1/2"

CRÊPINE DE LUXE

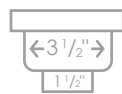

TAILLE DE L'ARMOIRE

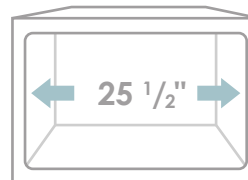

TAILLE MINIMALE
DE CAISSON INTERNE

ÉLIMINATION DES DÉCHETS

Les éviers AZUNI® possèdent une ouverture de siphon de 3 1/2" pouvant s'adapter à n'importe quel dispositif d'élimination des déchets. La structure de l'évier est bien conçue pour apporter tous les dispositifs d'élimination des déchets.



GARANTIE

Ce produit est couvert par une garantie à vie limitée. Consultez notre site internet pour obtenir tous les détails.

ENTRETIEN

Rincez et séchez votre évier avec un chiffon doux et propre, en veillant à frotter dans le sens du grain. Nous recommandons l'utilisation d'un doux mélange d'eau et de vinaigre pour éliminer les dépôts de minéraux qui peuvent éventuellement s'accumuler sur votre évier.

Utilisez des crèmes nettoyantes liquides non abrasives qui ne contiennent pas de chlore, d'hypochlorite de sodium ou d'acide chlorhydrique pour aider à conserver l'aspect original de votre évier. Assurez-vous de bien rincer votre évier et de l'essuyer. Nous recommandons l'utilisation d'une grille en acier inoxydable qui s'insère au fond de l'évier et le protège des rayures.



NORMES CONFORMES

Certifié cUPC
Certifié ISO 9001