

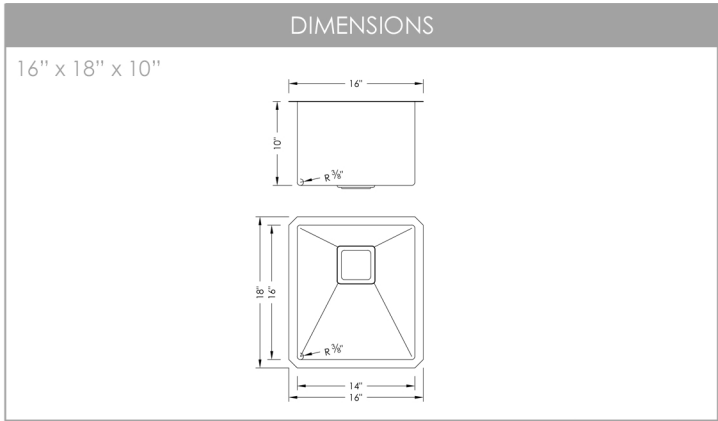

**KUBO**  
**S-509XG**  
 STAINLESS STEEL  
 HANDMADE SINGLE BOWL BAR SINK



**SURFACE FINISH**

BUSHED SATIN FINISH

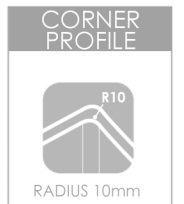

**INSULATION**

COATED + RUBBER PADS

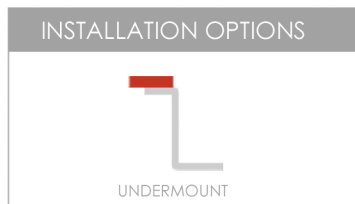
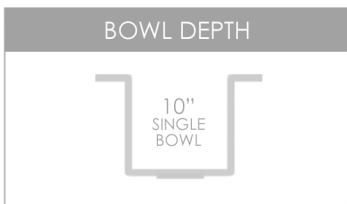

**MATERIAL**

Premium 16 gauge stainless steel with 18/10 chrome-nickel content. The 18% of chrome content provides durability, maximum protection against rust and a beautiful satin finish. The 10% of nickel content provides excellent strength and hardness.

**SUS 304** 16 GAUGE STAINLESS STEEL

**PRODUCT DIMENSIONS**

Overall Dimensions	16" x 18" x 10"
Internal Dimensions	14" x 16" x 10"
Left Basin	-
Right Basin	-
Drain Opening Size	3 1/2"

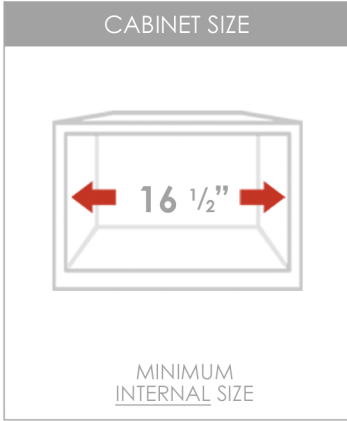
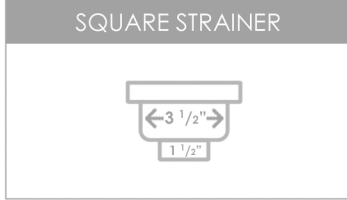

**GARBAGE DISPOSAL ADAPTOR**

For Stylish® sinks with square strainer, an extra kit (DA-01) is required in order to convert the square hole into round and to be able to install a garbage disposal unit.

DA-01 GARBAGE DISPOSAL ADAPTOR

**WARRANTY**

This product is covered by a limited lifetime warranty. Consult our website for complete details.

**STANDARDS COMPLIANCE**

cUPC certified  
 ISO 9001 Certified

**PRODUCT CARE**

Rinse and dry your sink with a clean soft cloth, working with, not a cross, the grain. We recommend the use of a mild solution of water and vinegar to remove any mineral deposits that may have built up on your sink. Use mild non-abrasive liquid cream cleaners that do not contain chlorine, sodium hypochlorite or hydrochloric acid to help maintain the original appearance of your sink. Ensure that you thoroughly rinse your sink and wipe it dry. We recommend the use of a stainless steel grid that fits inside the bottom of the sink bowl and protect the sink from scratches.



**KUBO**  
S-509XG

ÉVIER DE CUISINE À CUVE SIMPLE  
FAIT MAIN EN ACIER INOXYDABLE



DIMENSIONS

16" x 18" x 10"

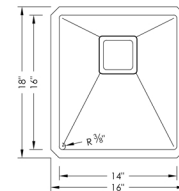
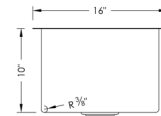

ACCESSOIRES INCLUS



G-509  
GRILLE



ST-04  
CRÉPINE

ACCESSOIRES RECOMMANDÉS



A-02  
ÉGOUTTOIR



A-905  
ÉGOUTTOIR



A-900  
SÉCHOIR



A-904  
PLANCHE À DÉCOUPER



S-01  
DISTRIBUTEUR DE SAVON

FINITION DE LA SURFACE

FINI SATINÉ BROSSÉ

DIMENSION DE L'ORIFICE DU DRAIN



PROFILÉ D'ANGLE



RAYON 10 mm

INSOLATION

TAMPONS ENROBES + EN CAOUTCHOUC

PROFONDEUR DE LA CUVE



OPTIONS D'INSTALLATION



ÉNCASTRE

MATÉRIEL

Acier inoxydable de première qualité de calibre 16 avec teneur en chrome-nickel 18/10. La teneur en chrome de 18 % assure une durabilité, une protection maximale contre la rouille et une belle finition satinée. La teneur en nickel de 10 % offre une excellente solidité et résistance.



CALIBRE 16  
ACIER INOXYDABLE

DIMENSIONS DU PRODUIT

Dimensions Hors Tout	16" x 18" x 10"
Dimensions Intérieures	14" x 16" x 10"
Cuve Gauche	-
Cuve Droite	-
Taille d'ouverture du Drain	3 1/2"

CRÉPINE CARRÉE

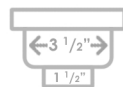

TAILLE DE L'ARMOIRE

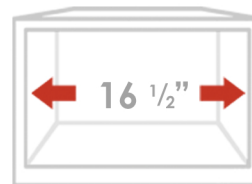

TAILLE MINIMALE DE CAISSON INTERNE

ÉLIMINATION DES DÉCHETS

Pour les éviers Stylish® avec crépines carrées, un équipement supplémentaire (DA-01) est nécessaire pour transformer le trou carré en rond et pour pouvoir installer un dispositif d'élimination des déchets.

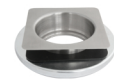

DA-01  
ÉLIMINATION DES DÉCHETS

GARANTIE

Ce produit est couvert par une garantie à vie limitée. Consultez notre site internet pour obtenir tous les détails.

ENTRETIEN

Rincez et séchez votre évier avec un chiffon doux et propre, en veillant à frotter dans le sens du grain. Nous recommandons l'utilisation d'un doux mélange d'eau et de vinaigre pour éliminer les dépôts de minéraux qui peuvent éventuellement s'accumuler sur votre évier.

Utilisez des crèmes nettoyantes liquides non abrasives qui ne contiennent pas de chlore, d'hypochlorite de sodium ou d'acide chlorhydrique pour aider à conserver l'aspect original de votre évier. Assurez-vous de bien rincer votre évier et de l'essuyer. Nous recommandons l'utilisation d'une grille en acier inoxydable qui s'insère au fond de l'évier et le protège des rayures.

NORMES CONFORMES

Certifié cUPC  
Certifié ISO 9001

Stylish International Inc



www.stylishkb.com



stylish.international.inc



care@stylishkb.com



+1-855-789-5352