

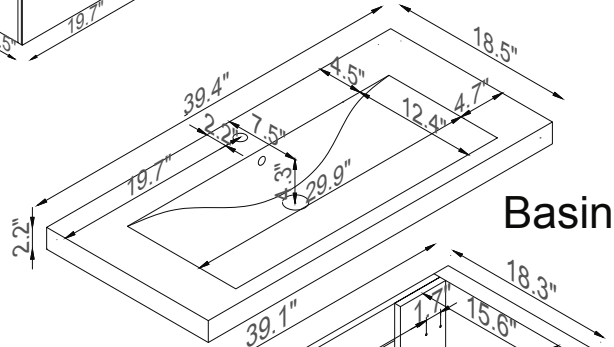

Streamline

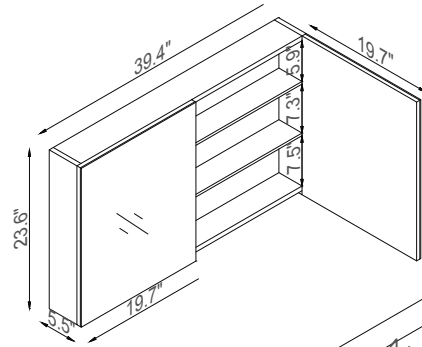

Basin

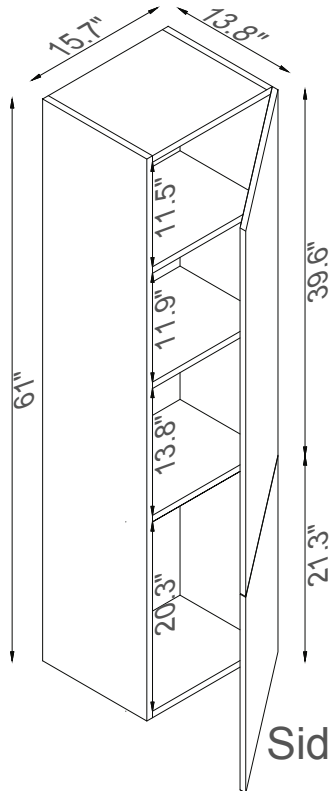

Side Cab.

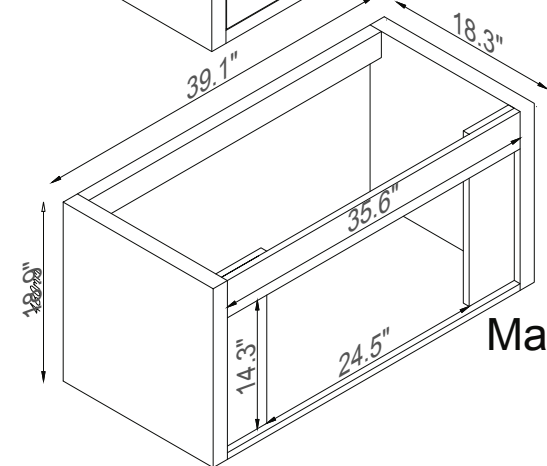
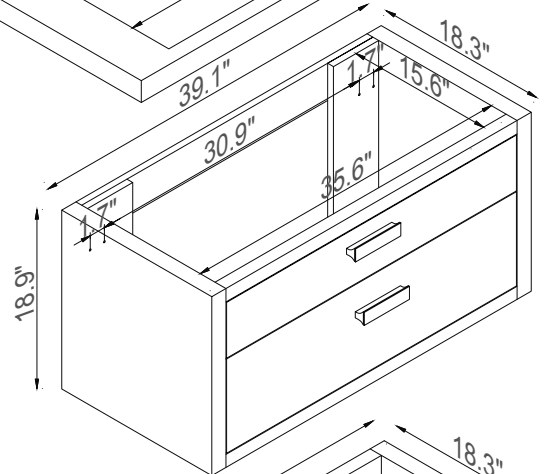

Master Cabinet

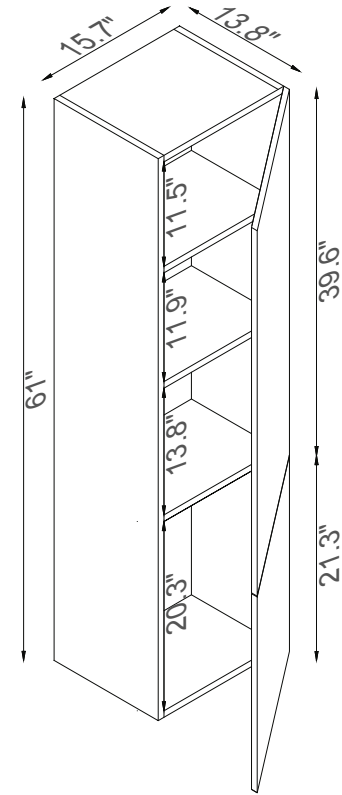

Side Cab.

K1820-098-40-55MR2S