

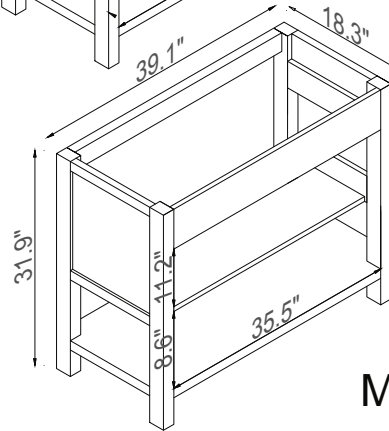

Streamline

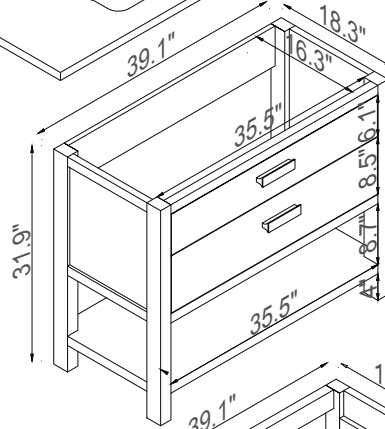
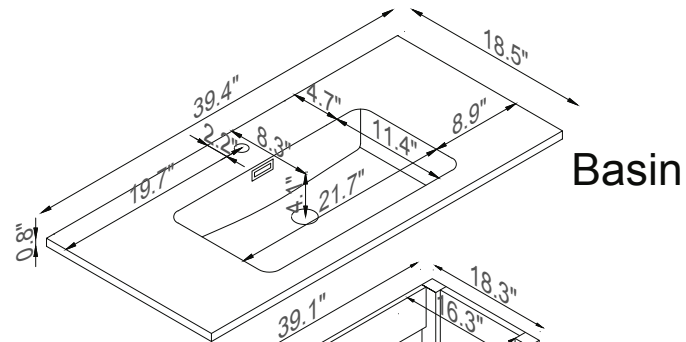
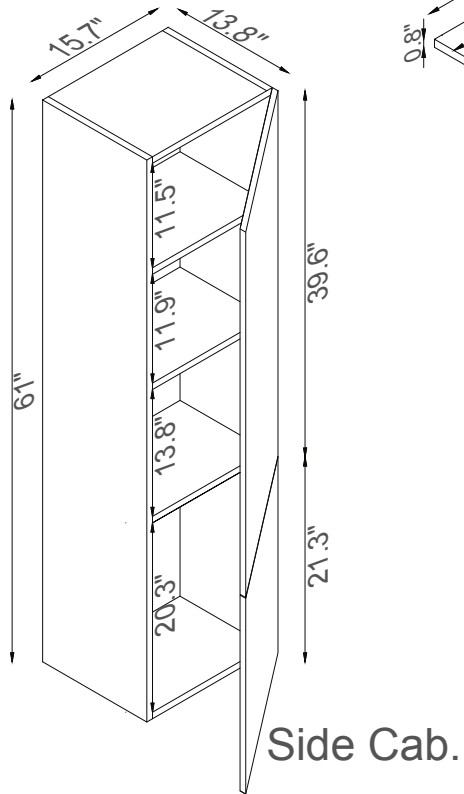

K1803-161-40-511S