

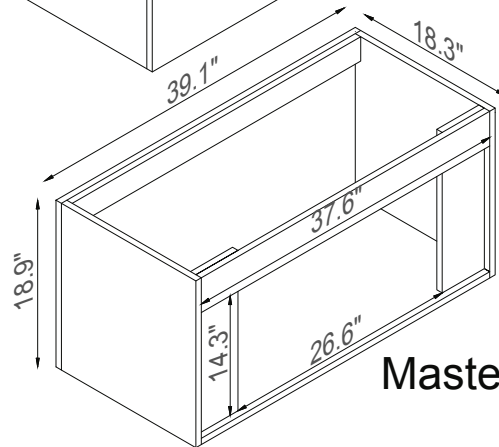

Streamline

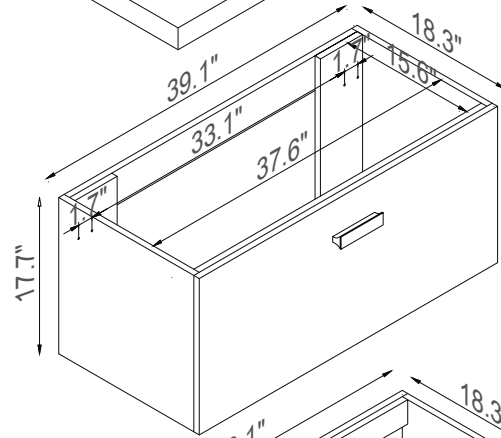
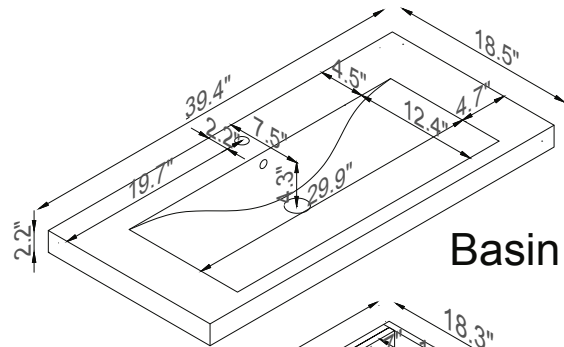

K1801-098-40-55