

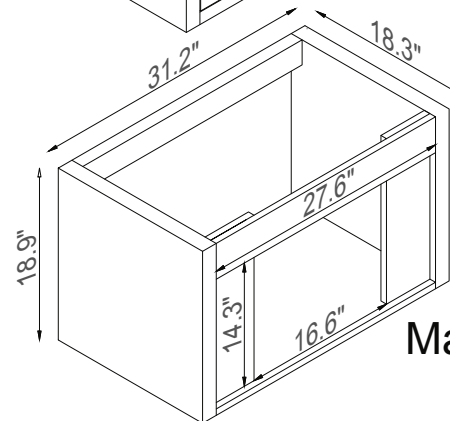

Streamline

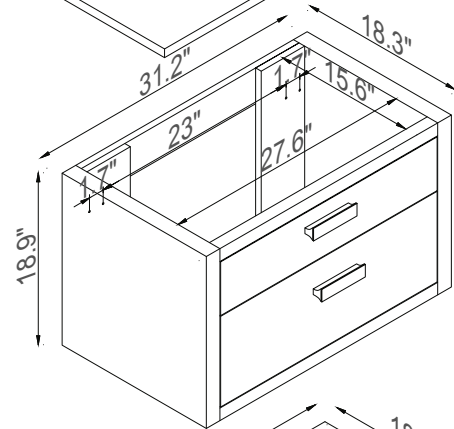
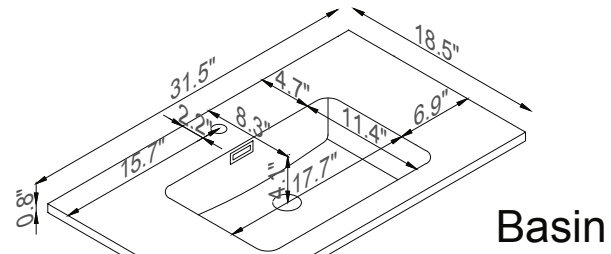
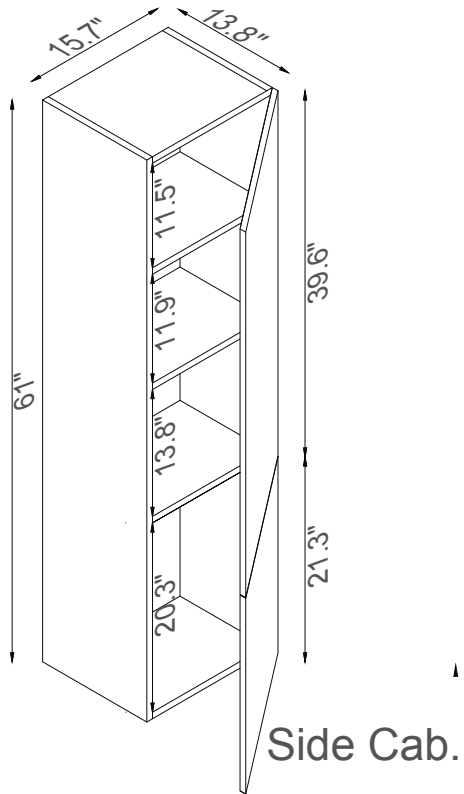

K1820-161-32-511S