

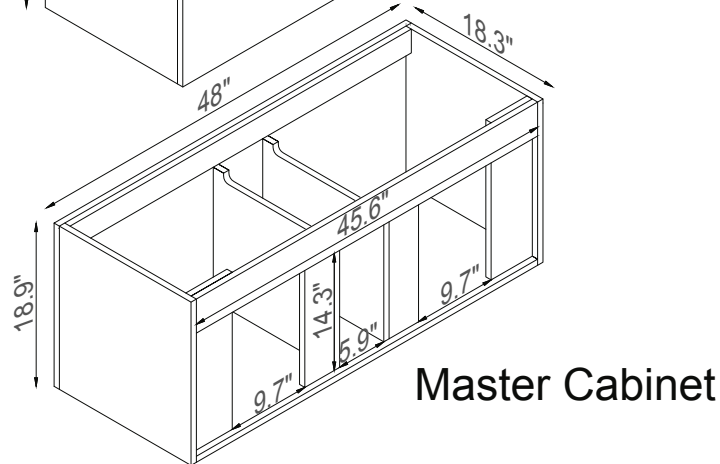

Streamline

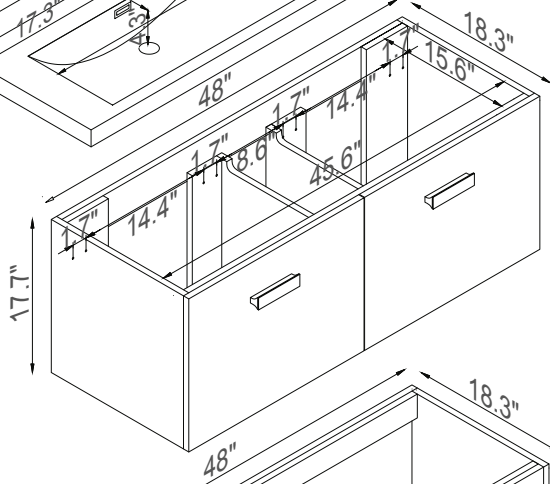
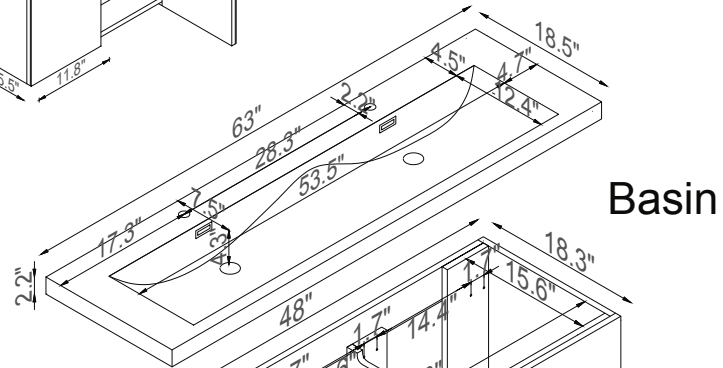
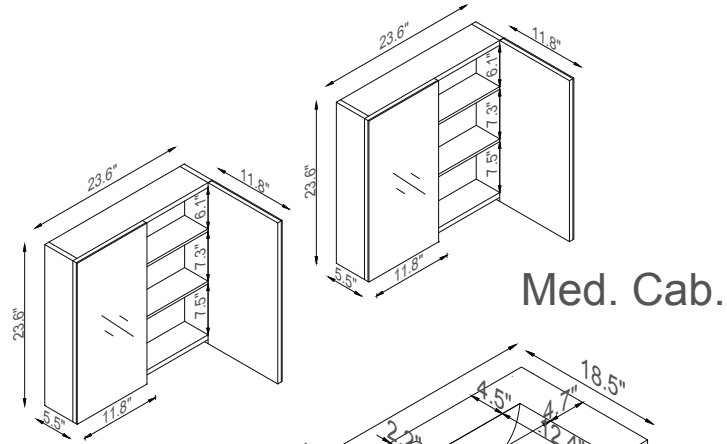

K1801-098-63-55MR