

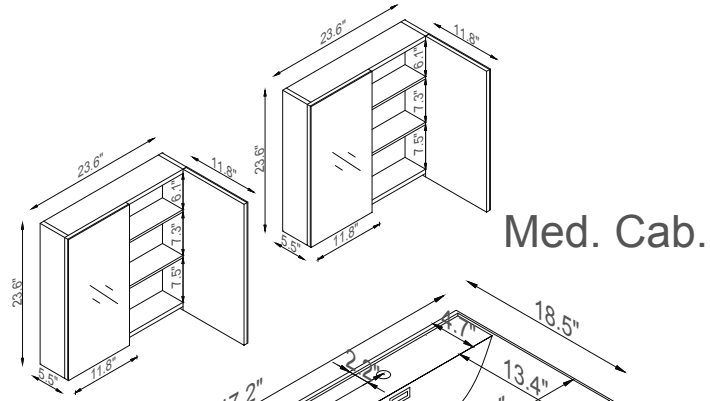

Streamline

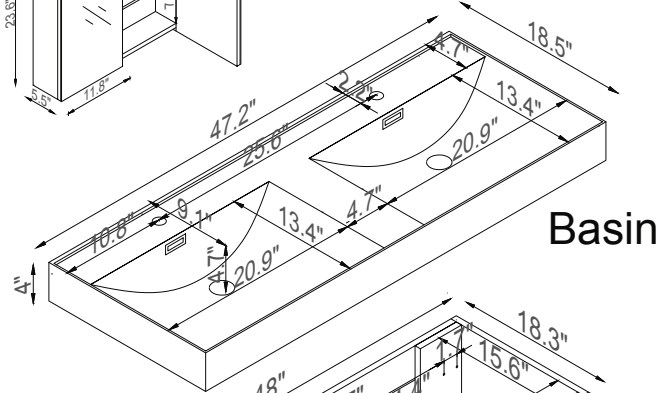

Med. Cab.



Basin

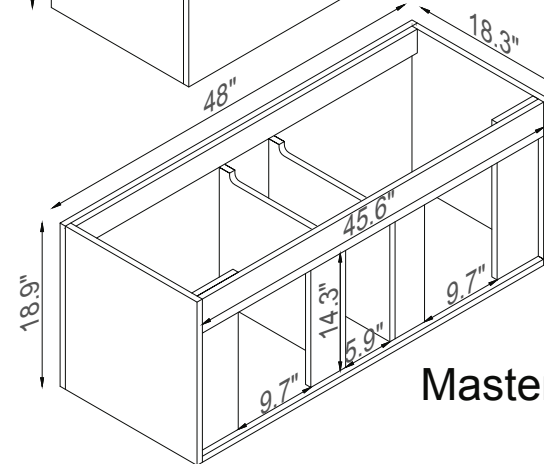
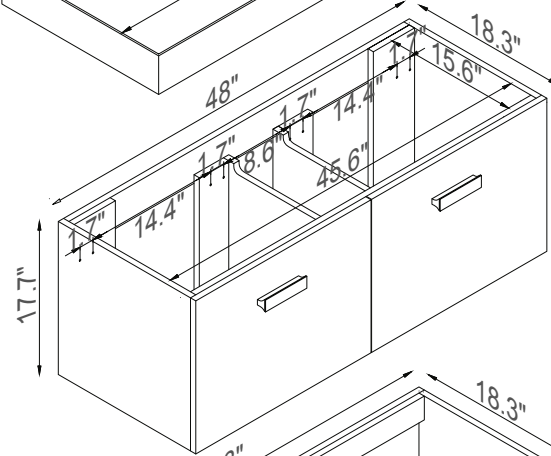

Master Cabinet

K1801-170-48-55MR