

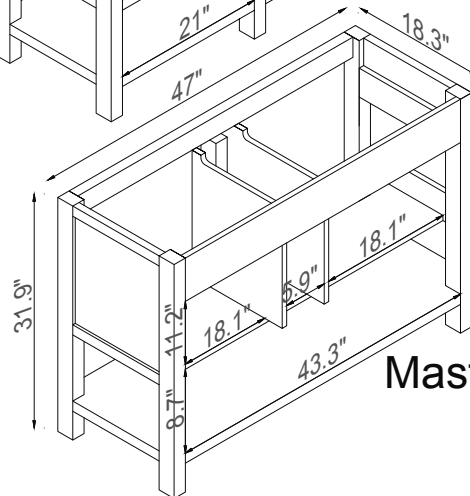

Streamline

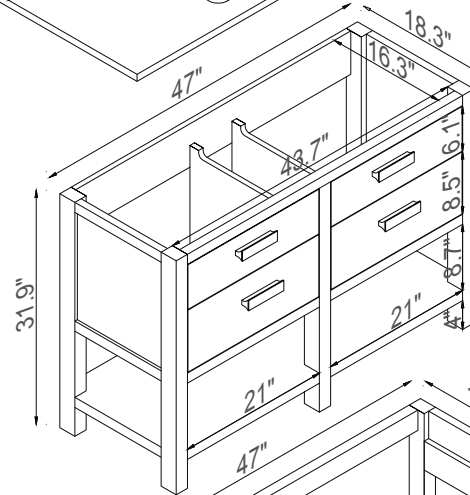
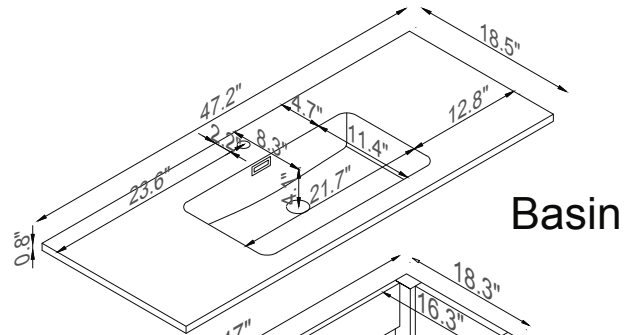

K1803-161-48-51