

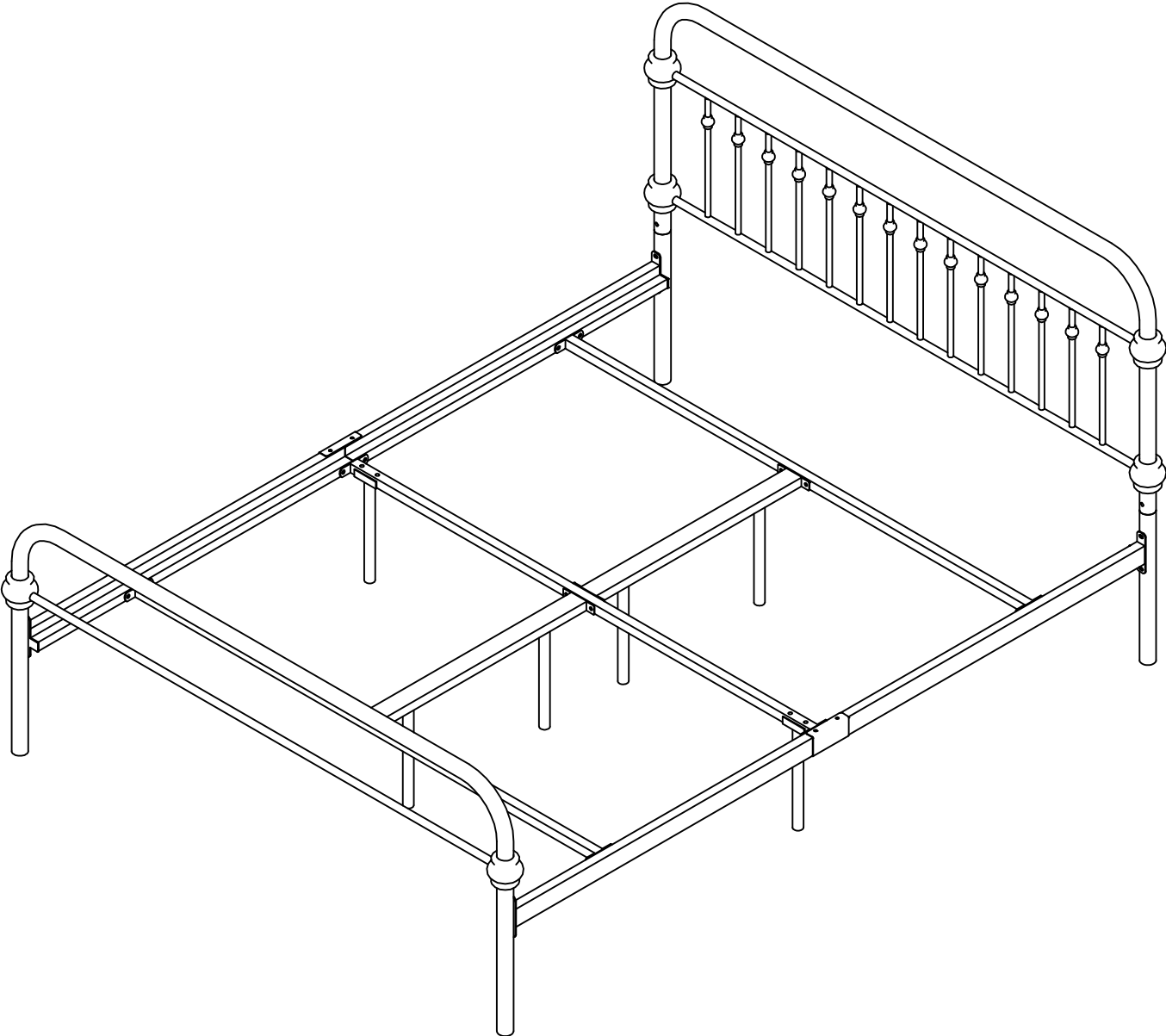









GOBERT QU





A		M6x65mm	x4
B		M6x35mm	x6
C		M6x30mm	x2
D		M6x15mm	x32
E			x2
F		M6	x10
G			x1
H			x1
I			x1

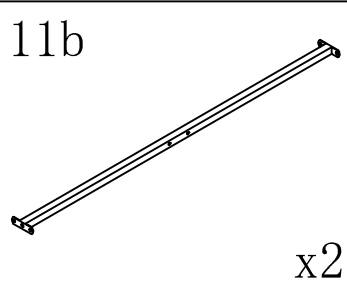
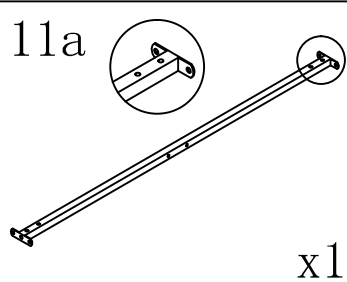
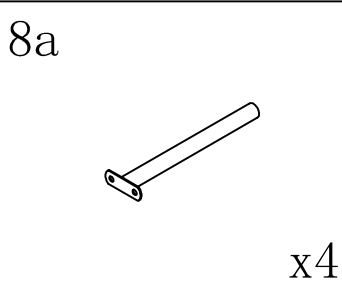
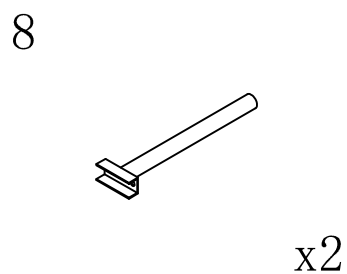
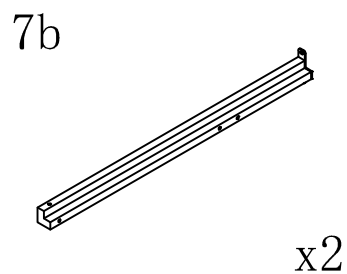
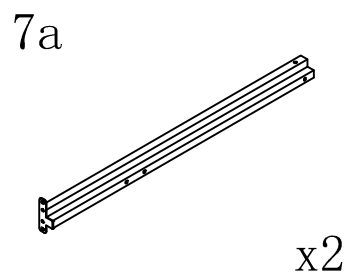
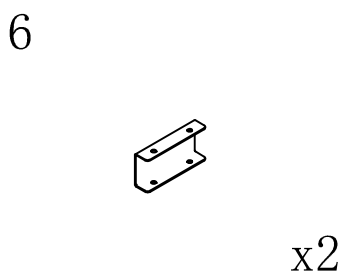
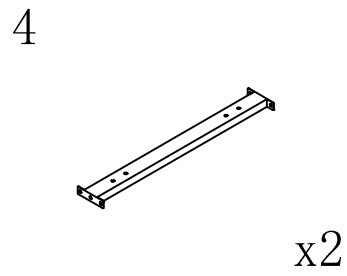
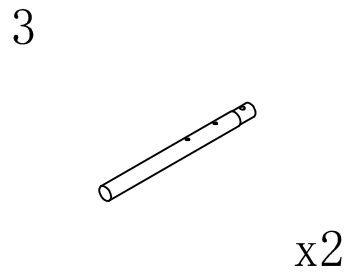
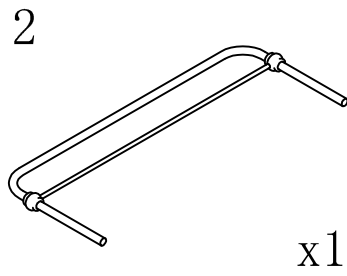
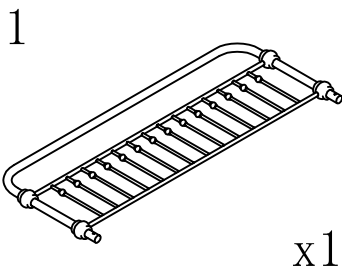
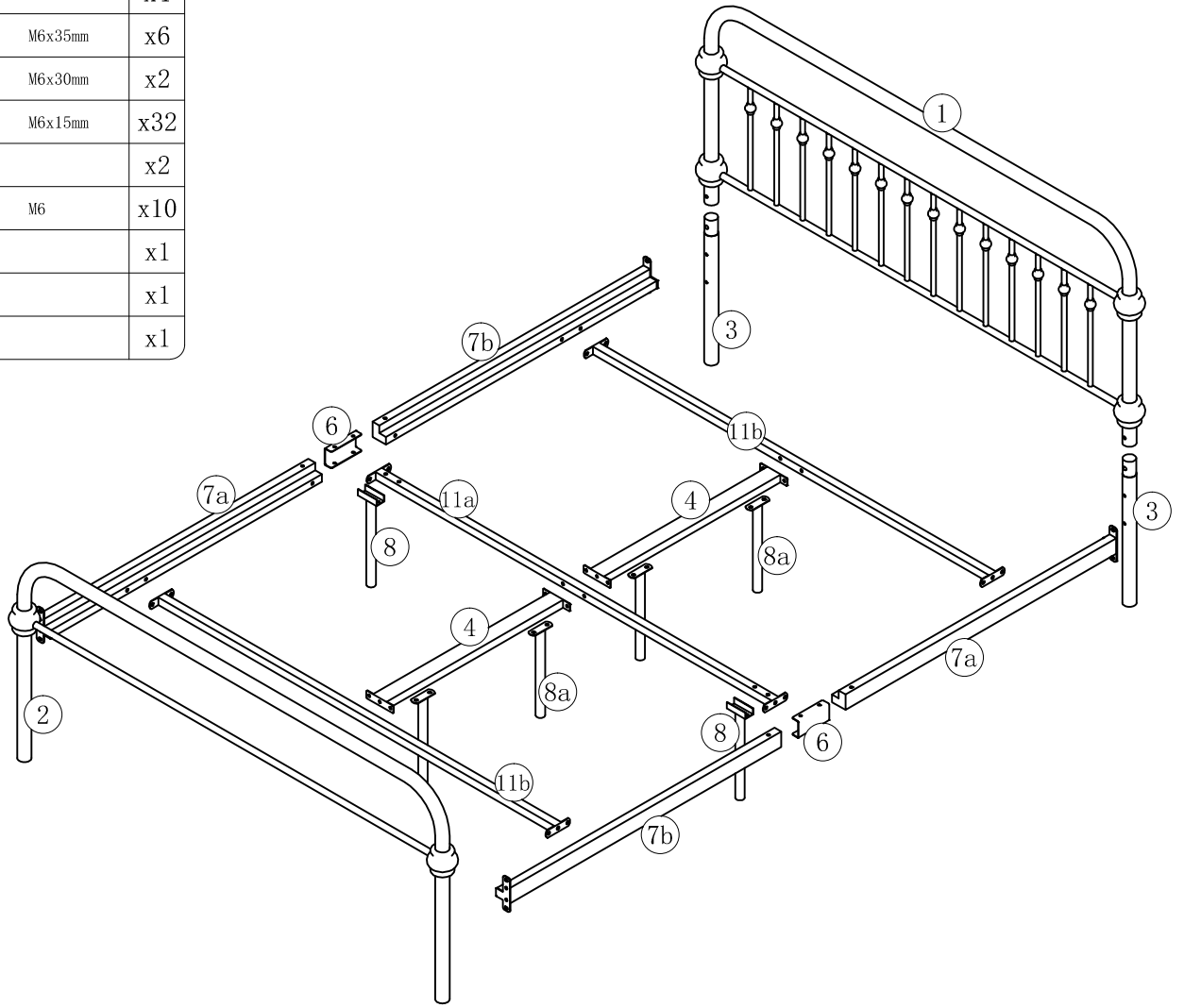

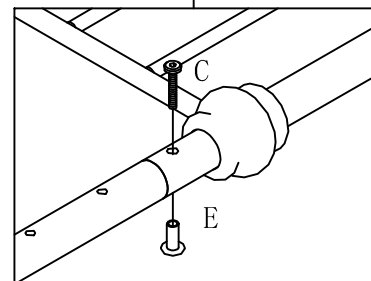
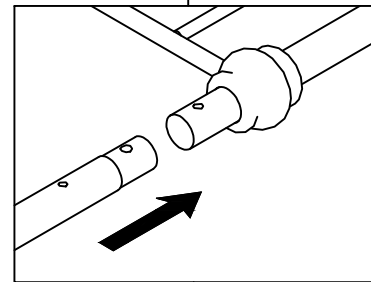
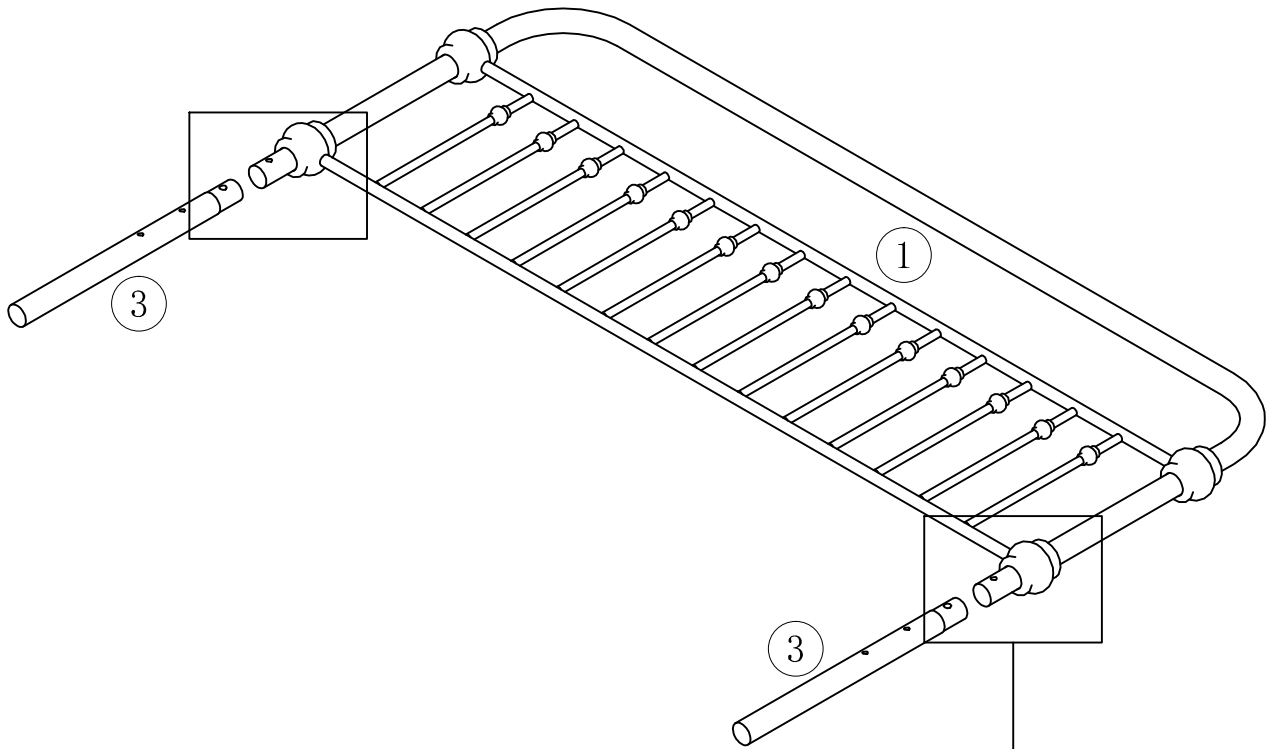
STEP 1



C		x2
E		x2

STEP 2

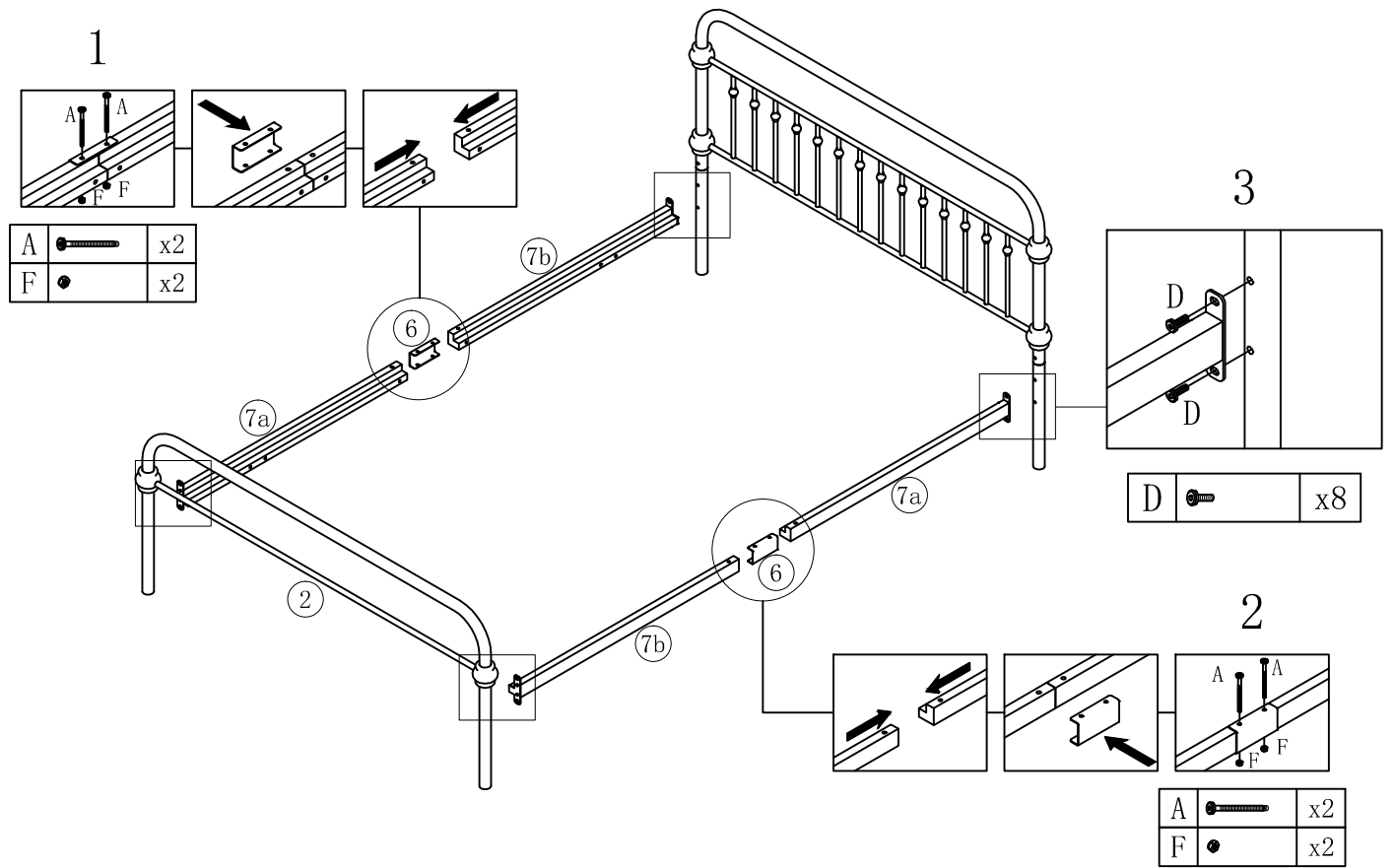

STEP 3

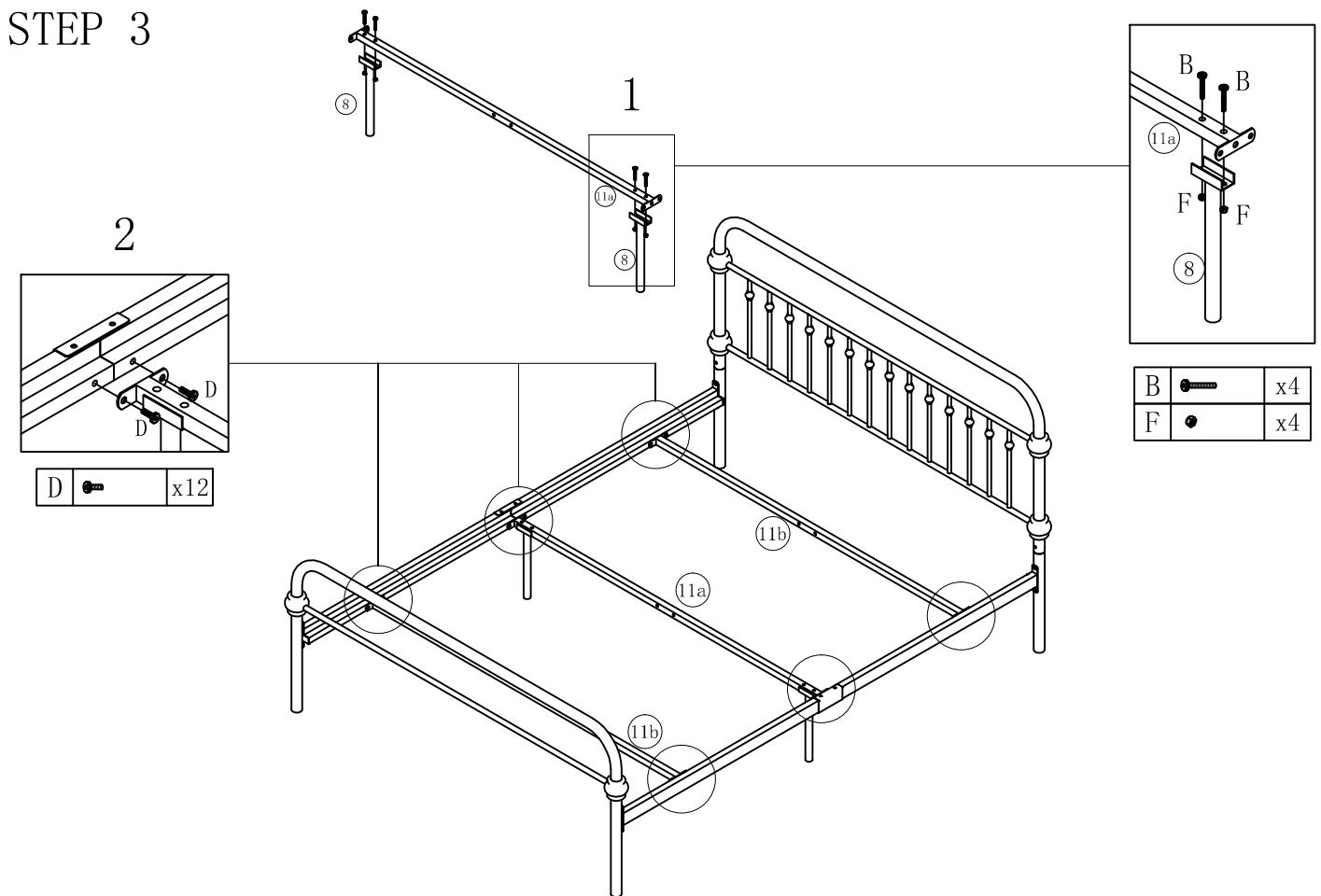

STEP 4

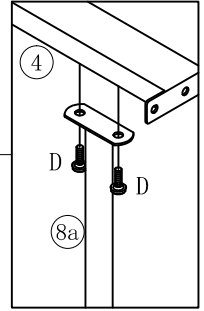
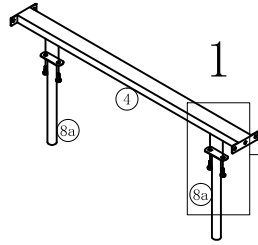

D		x8
---	--	----

2

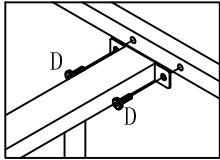

D		x4
---	--	----

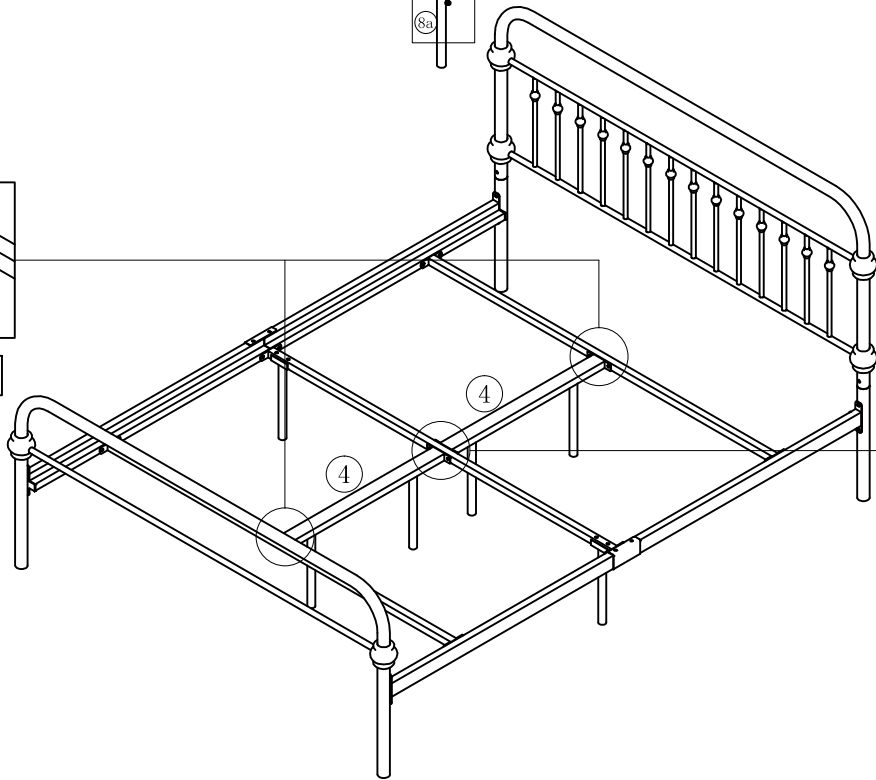

3

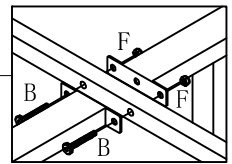

B		x2
F		x2