

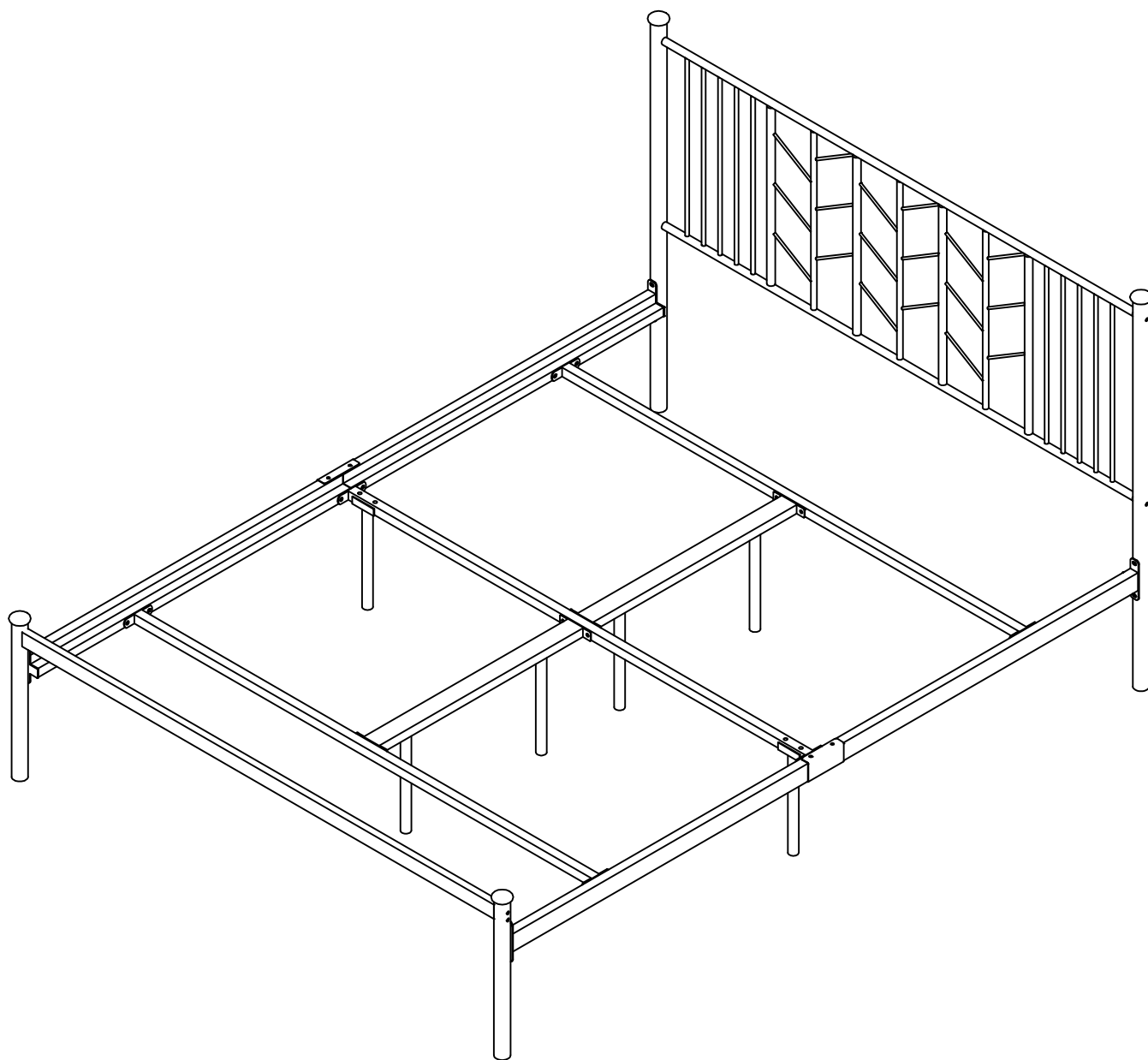









MIYE QU



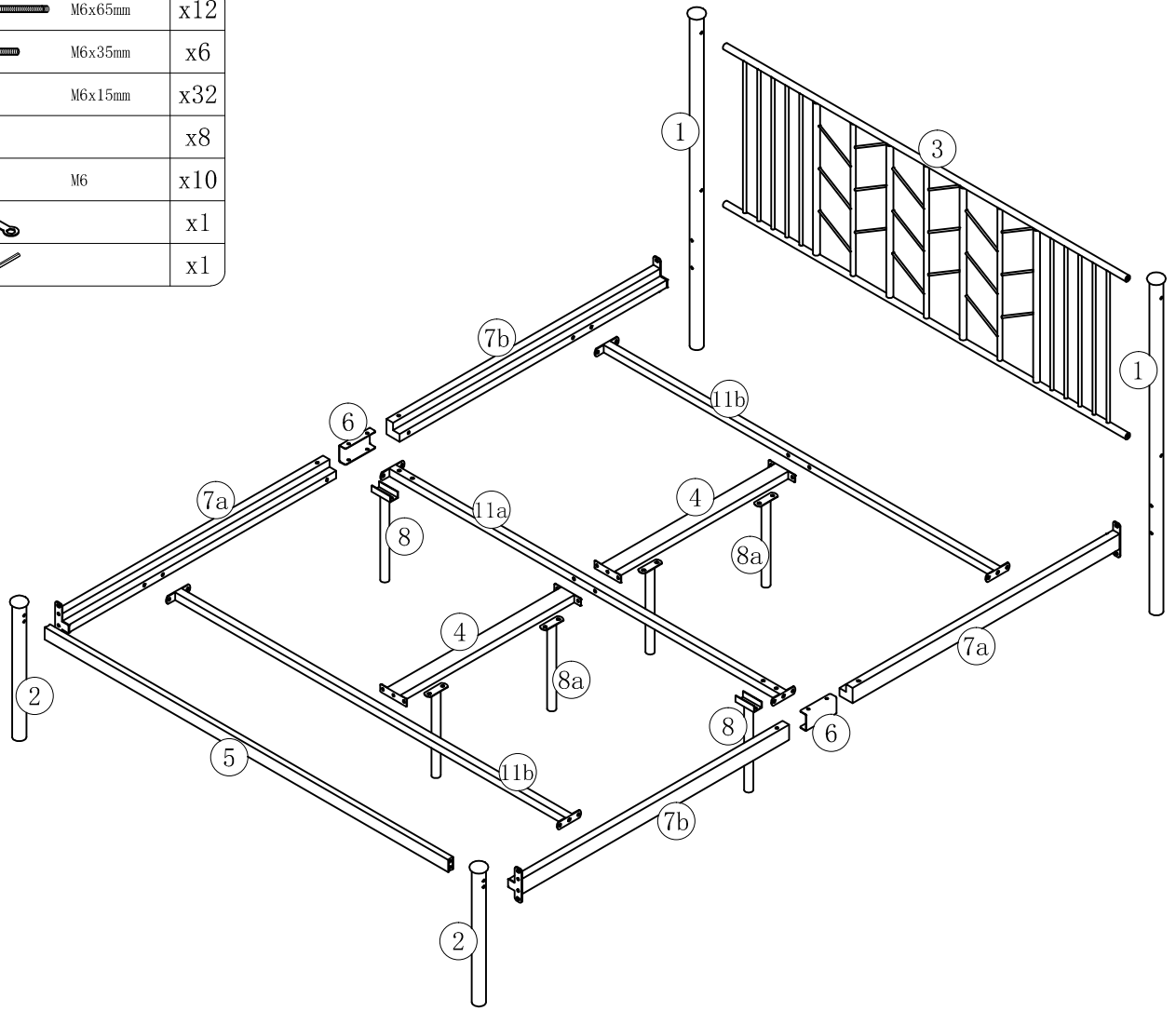
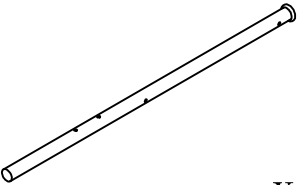
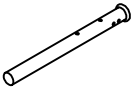
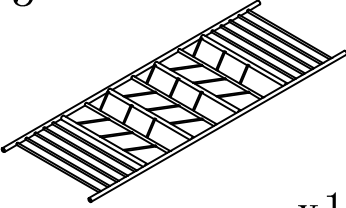
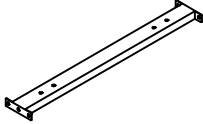
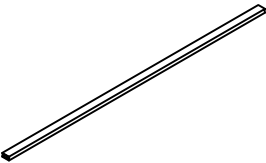

A		M6x65mm	x12
B		M6x35mm	x6
C		M6x15mm	x32
D			x8
E		M6	x10
F			x1
G			x1

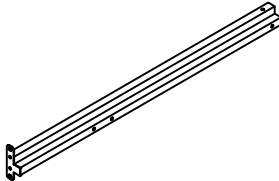
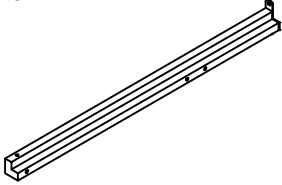
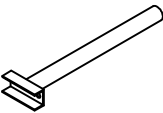
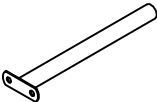
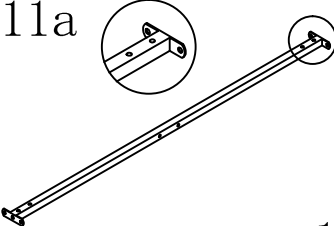
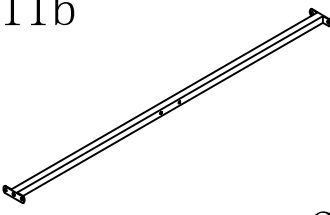

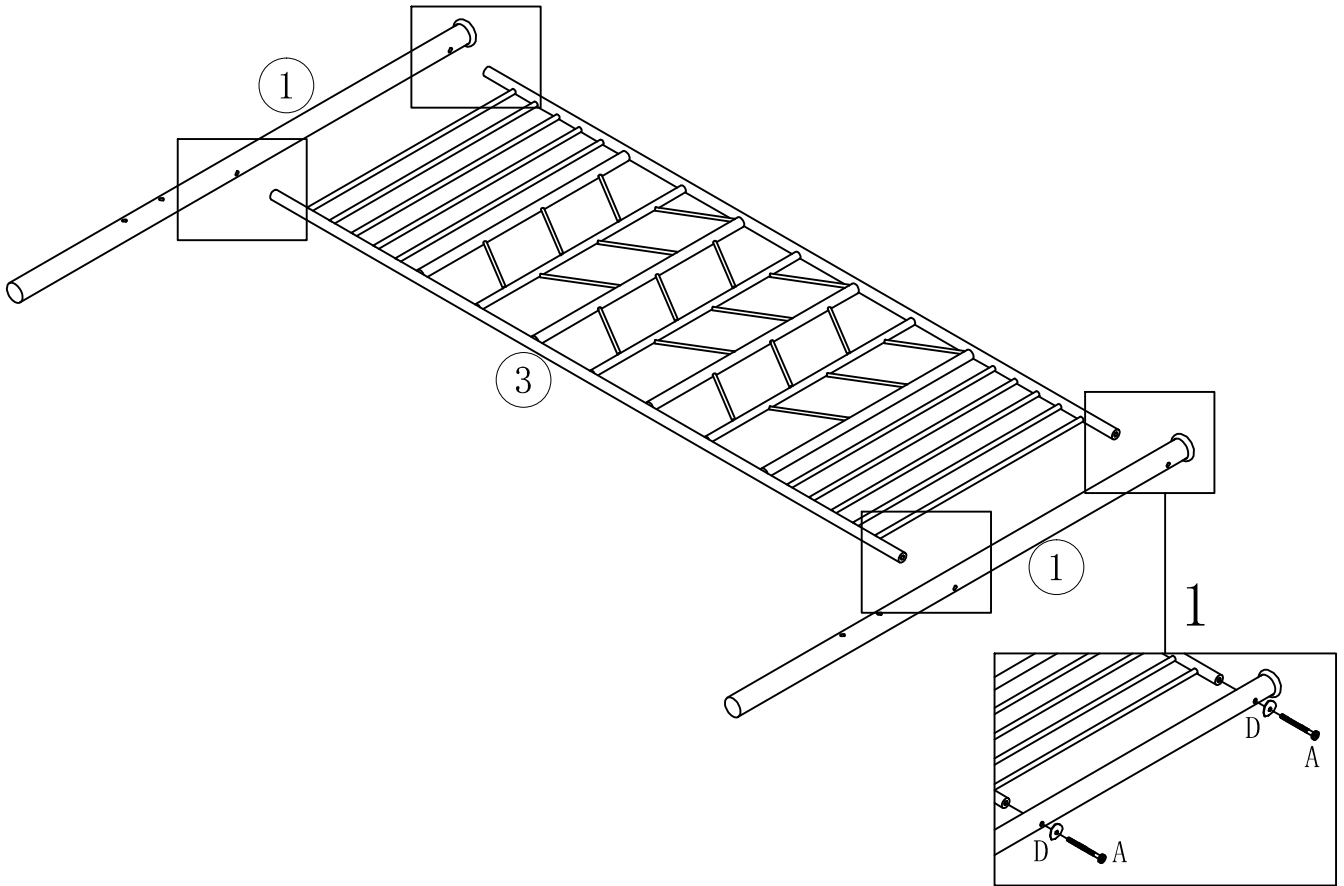

1  x2	2  x2	3  x1	4  x2
5  x1	6  x2	7a  x2	7b  x2
8  x2	8a  x4	11a  x1	11b  x2

STEP 1

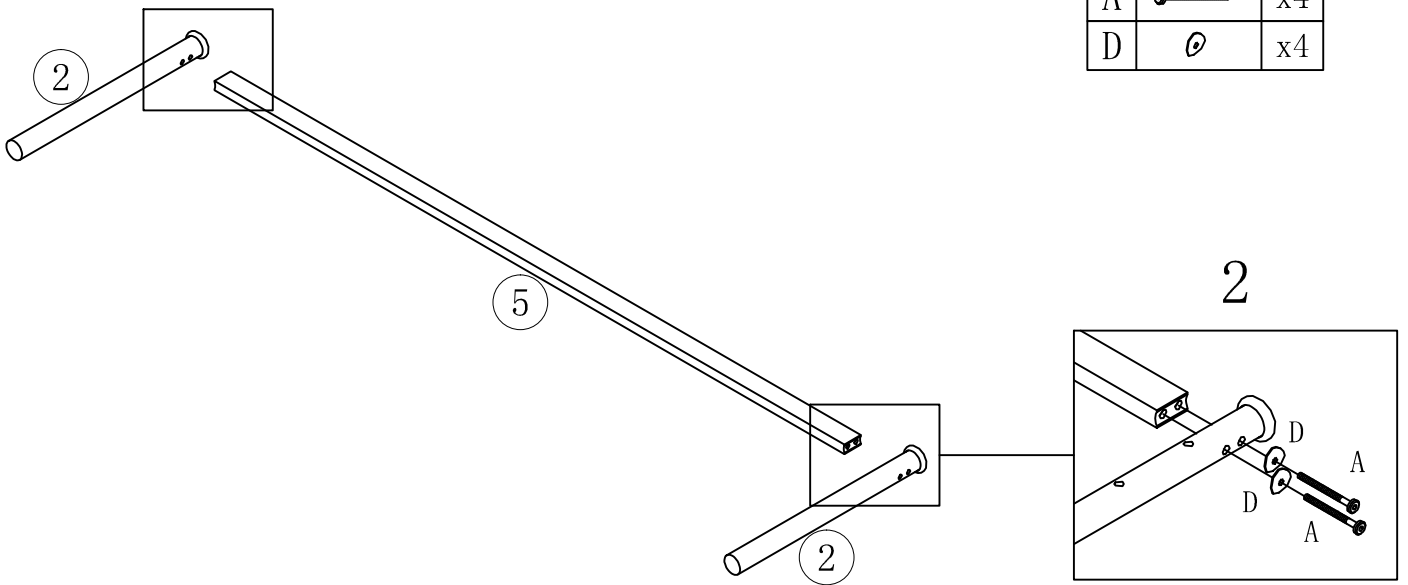

A		x4
D		x4



A		x4
D		x4

STEP 2

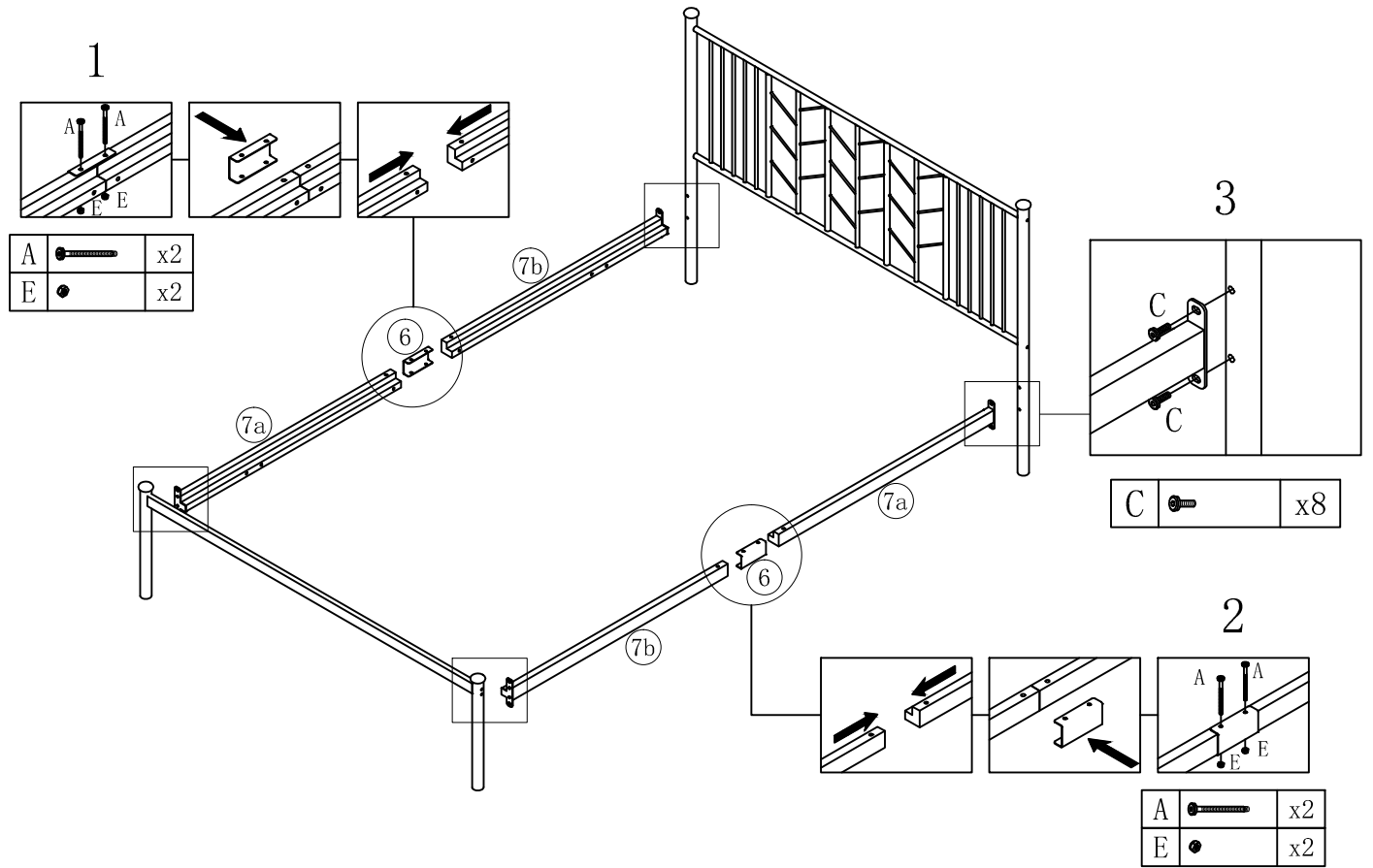

STEP 3

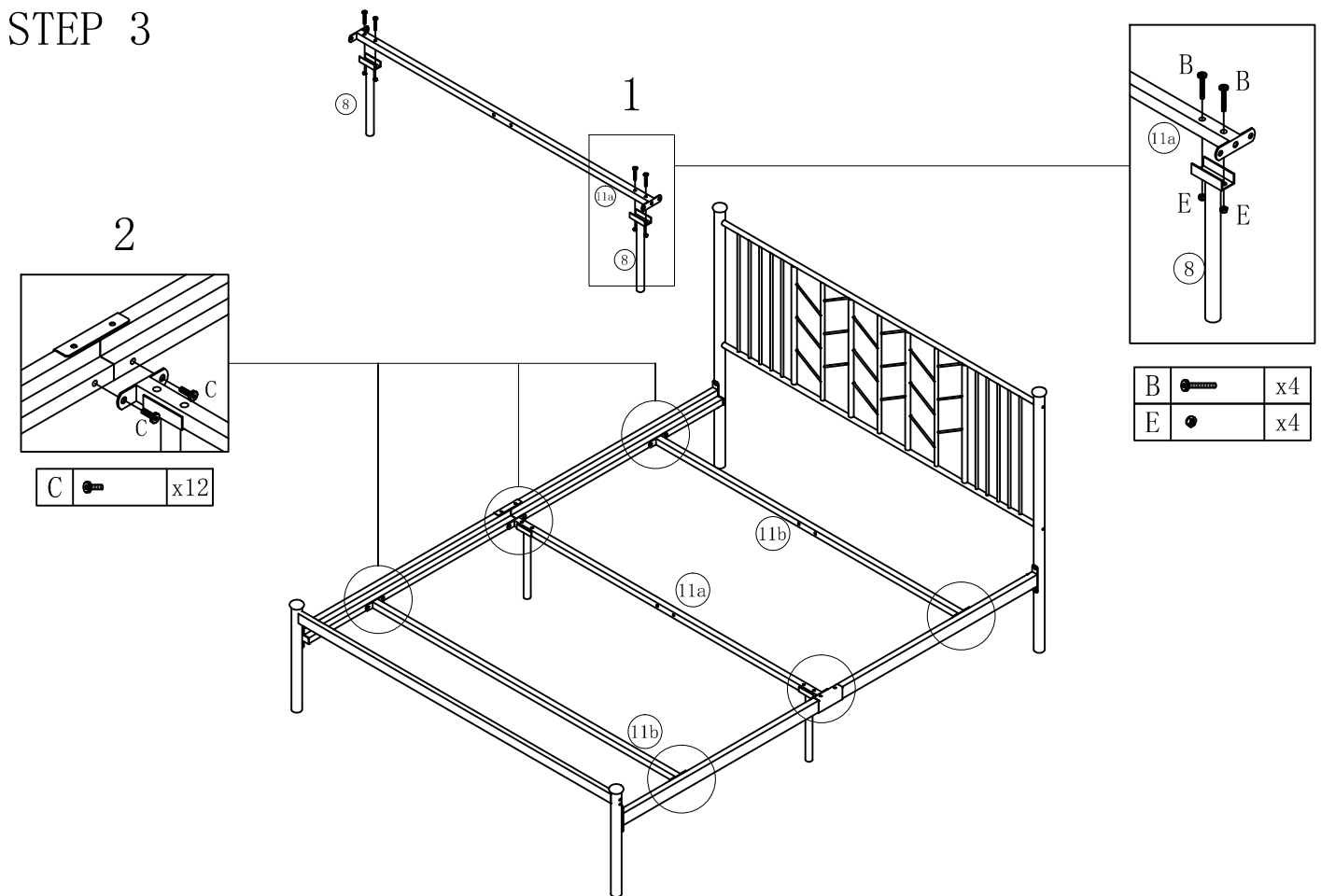

STEP 4

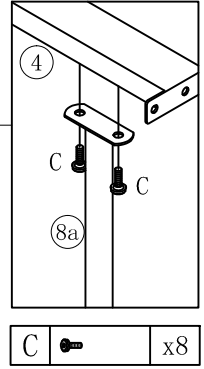
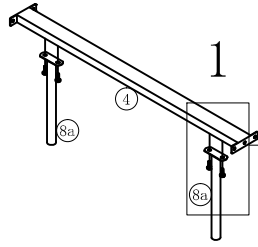

2

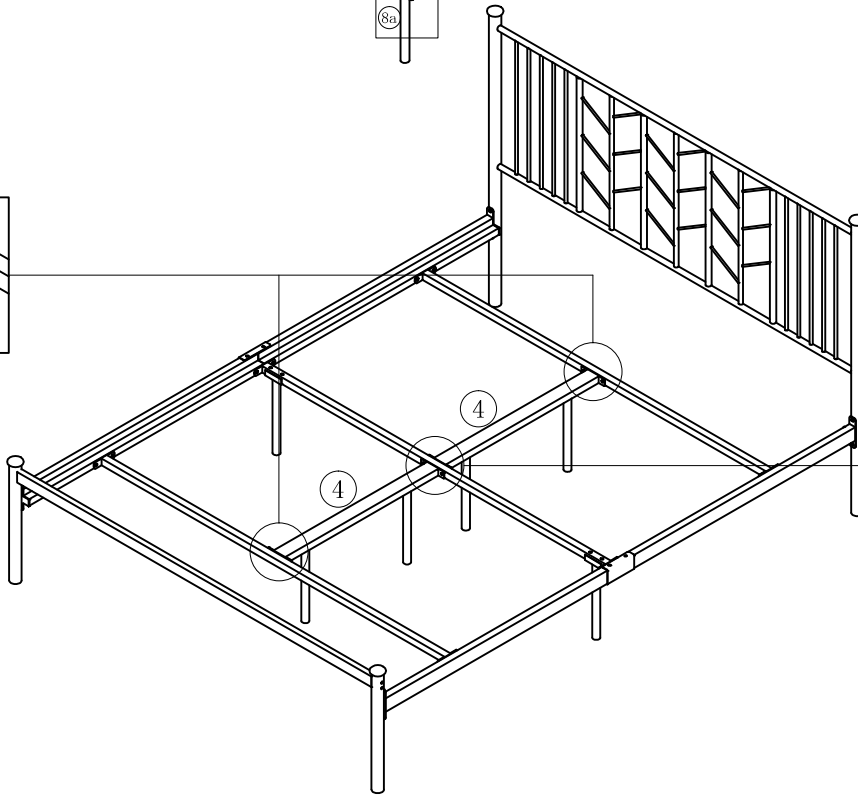
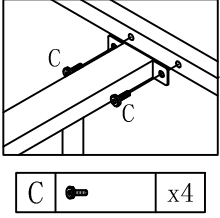

3

