



**ASSEMBLY GUIDE
GUIDE DE MONTAGE
GUÍA DE MONTAJE**

MEZZA

MINI PARKLETTE PLANTER

JARDINIÈRE MINI PARKLETTE
PLANTADOR DE MINI PARKLETTE

VT17715

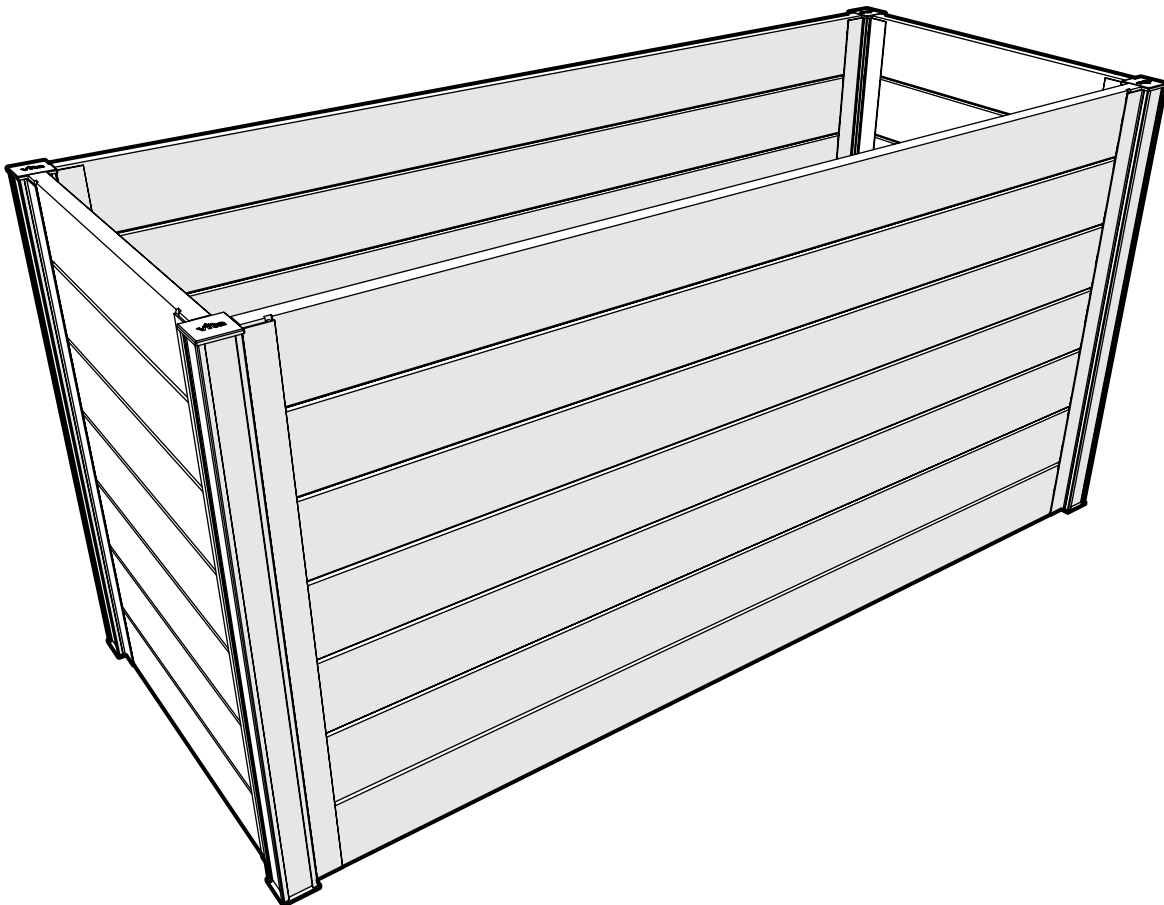

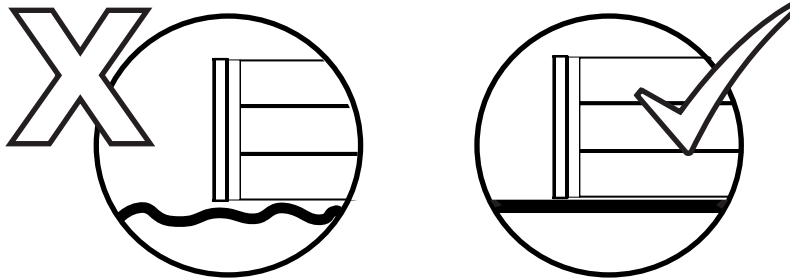
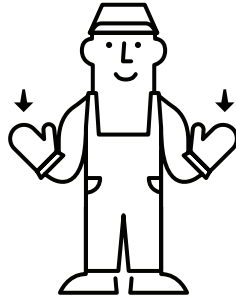
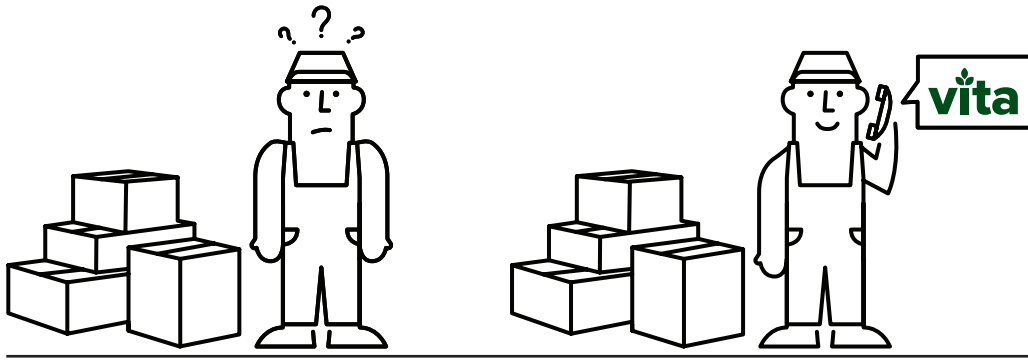

 1-800-282-9346



HELLO@WEAREVITA.COM



WWW.WEAREVITA.COM



8:00 AM - 5:00 PM EST



PARTS LIST

LISTE DES PIÈCES

LISTA DE PARTES



17041 - POST - PUBLIER - EXPONER - 19 1/4" (48.7 CM) - **X4**

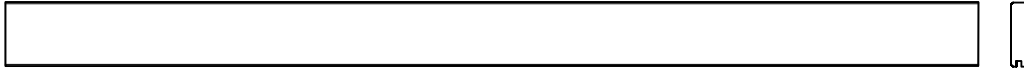

17042
TOP BOARD A - CONSEIL SUPERIEUR A - TABLERO SUPERIOR A
36 1/2" (92.7 CM) - **X2**



17043
TOP BOARD B - CONSEIL SUPERIEUR B - TABLERO SUPERIOR B
13 1/2" (34.3 CM) - **X2**



17044
STACKING BOARD C - TABLEAU DE EMPILAGE C - PTABLERO DE APILAMIENTO C
36 1/2" (92.7 CM) - **X10**

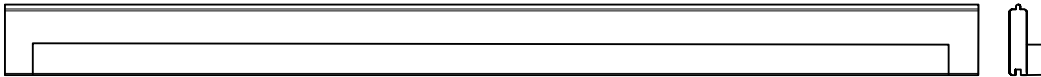

17046
FLOOR BRACE BOARD - CONSEIL DE RENFORT DE PLANCHER - JUNTA DE SOPORTE DE PISO
36 1/2" (92.7 CM) - **X2**



17045
STACKING BOARD D - TABLEAU DE EMPILAGE D - PTABLERO DE APILAMIENTO D
13 1/2" (34.3 CM) - **X12**

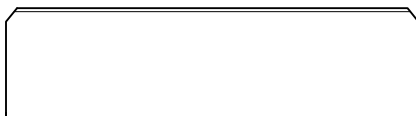

17047
FLOOR BOARD E - PLANCHE D'ÉTAGE E - TABLERO DE PISO E
14" (35.6 CM) - **X2**

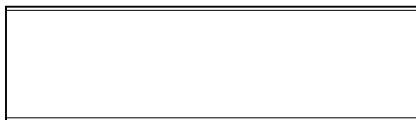

17048
FLOOR BOARD F - PLANCHE D'ÉTAGE F - TABLERO DE PISO F
14" (35.6 CM) - **X10**



17049
FLOOR BOARD G - PLANCHE D'ÉTAGE G - TABLERO DE PISO G
14" (35.6 CM) - **X1**

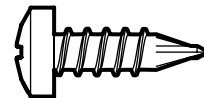

20066
SCREW - VISSER - TORNILLO
1/2IN (1.6CM) - **X8**



17020
POST CAP - ETE DE POTEAU - TAPON
1 1/4" X 1 1/4" (3.2 CM x 3.2 CM) - **X8**

PRODUCT DIMENSIONS DIMENSIONS DU PRODUIT DIMENSIONES DEL PRODUCTO

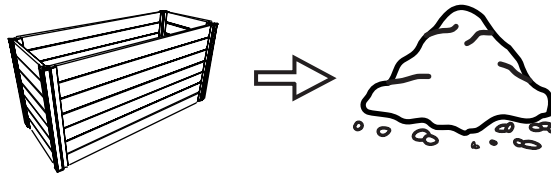
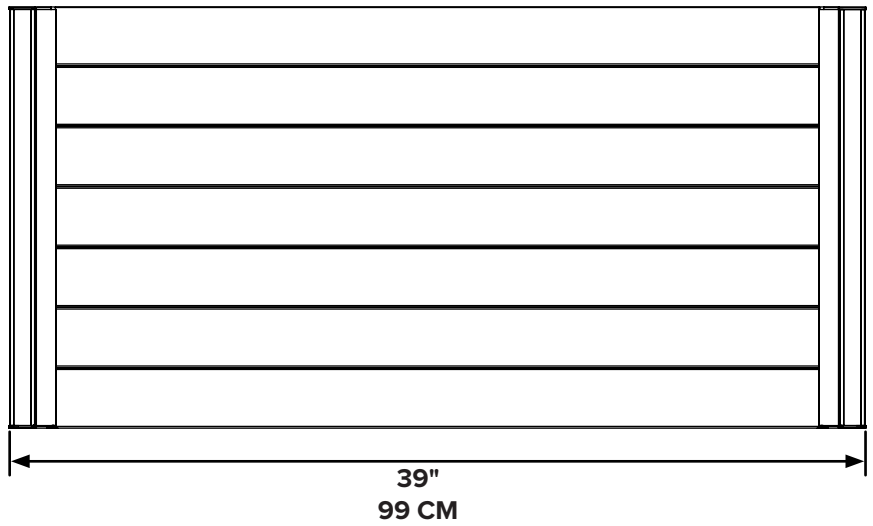
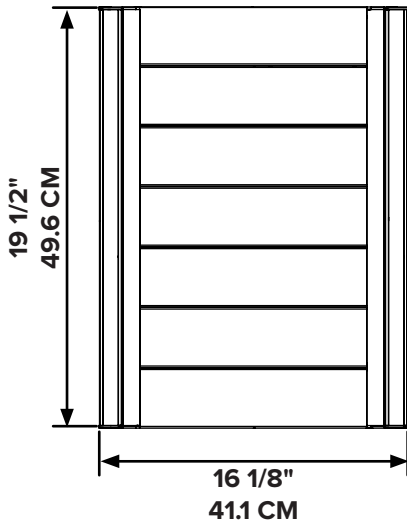
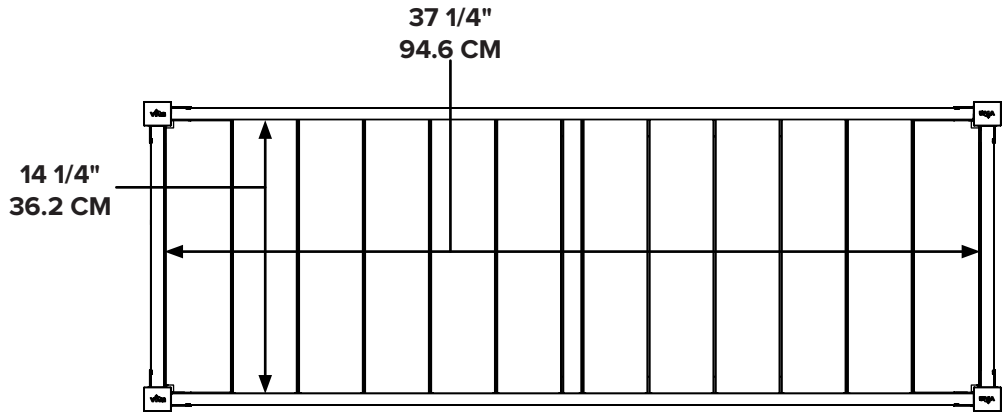

CU M ----- 0.18

CU FT ----- 6.2

 ----- **X5-6**
(30L/1.5CU FT.)

1

17041 - x4 

17020 - x4 



x4



2

17044 - x2 

17045 - x2 

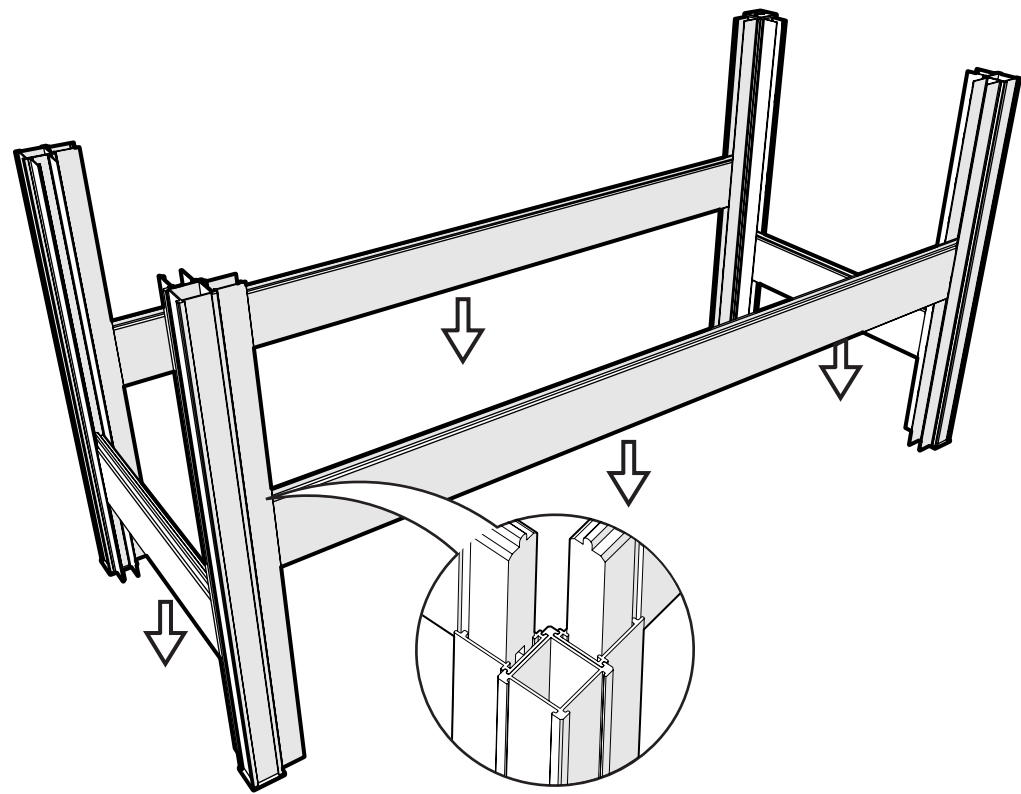

3

20066 - x8 

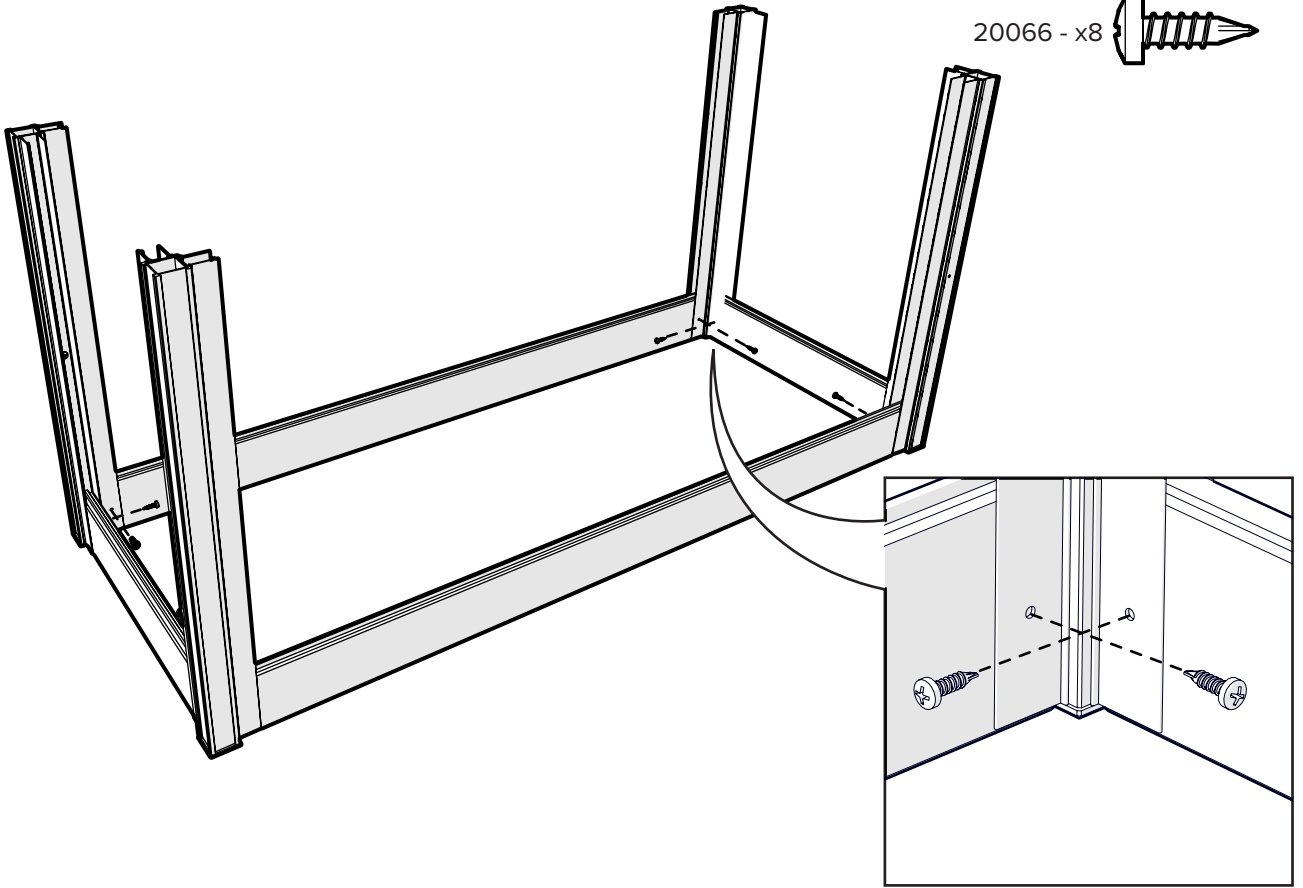

4

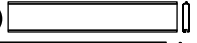
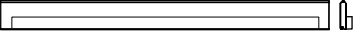
17045 - x2 
17046 - x2 

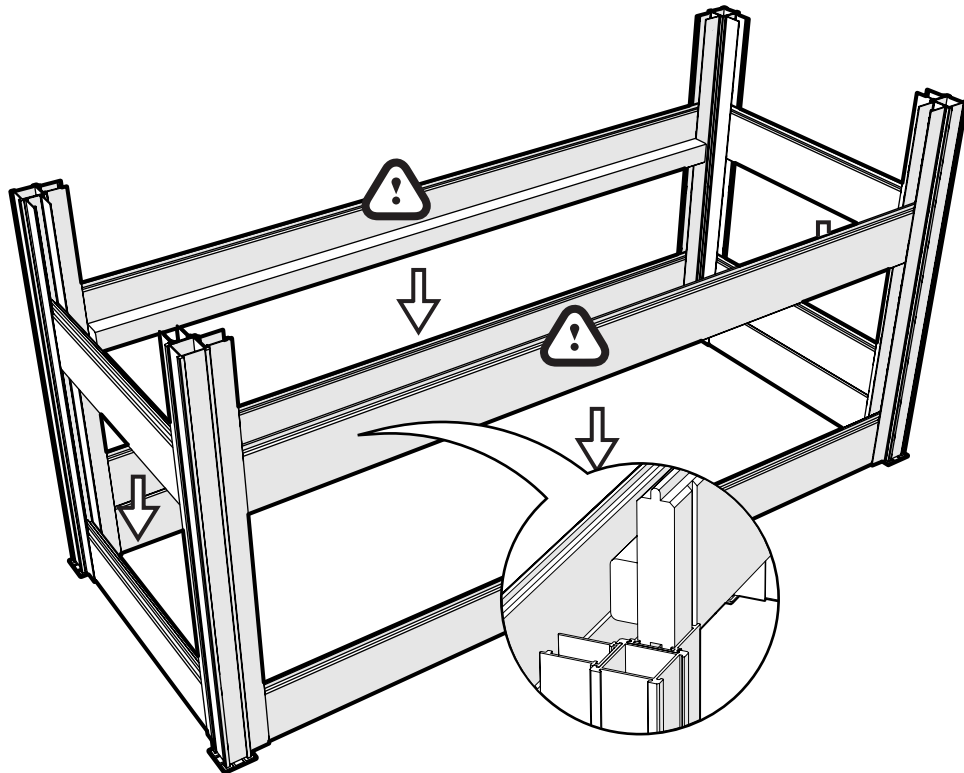

6

5

17044 - x8 

17045 - x8 

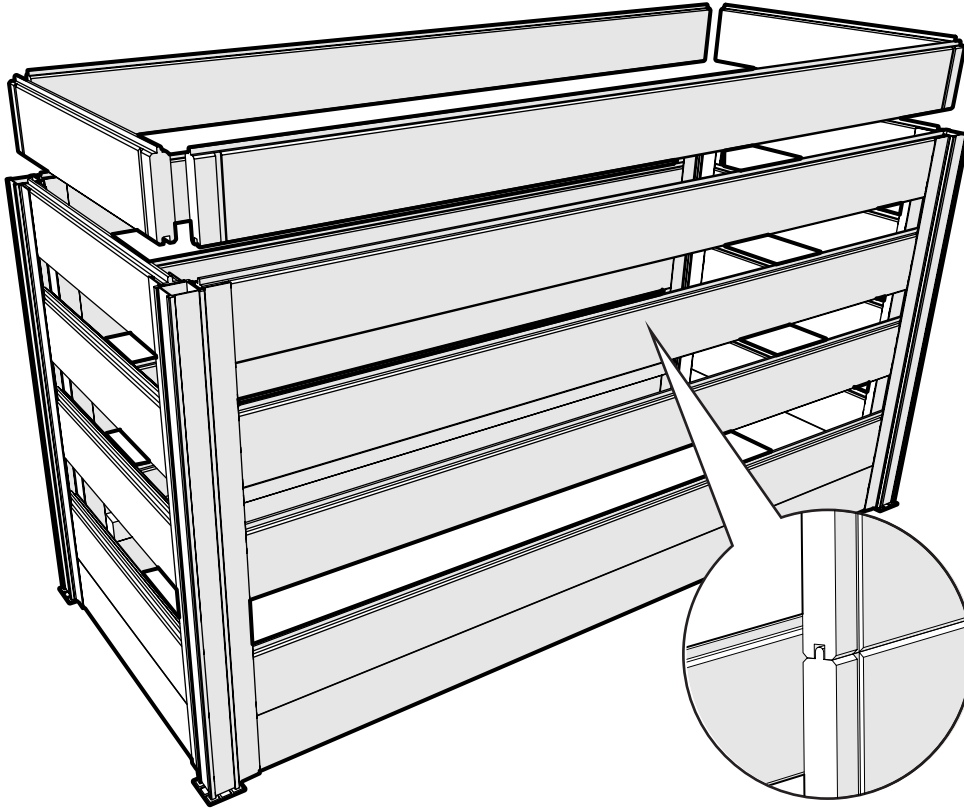

6

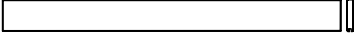
17042 - x2 

17043 - x2 

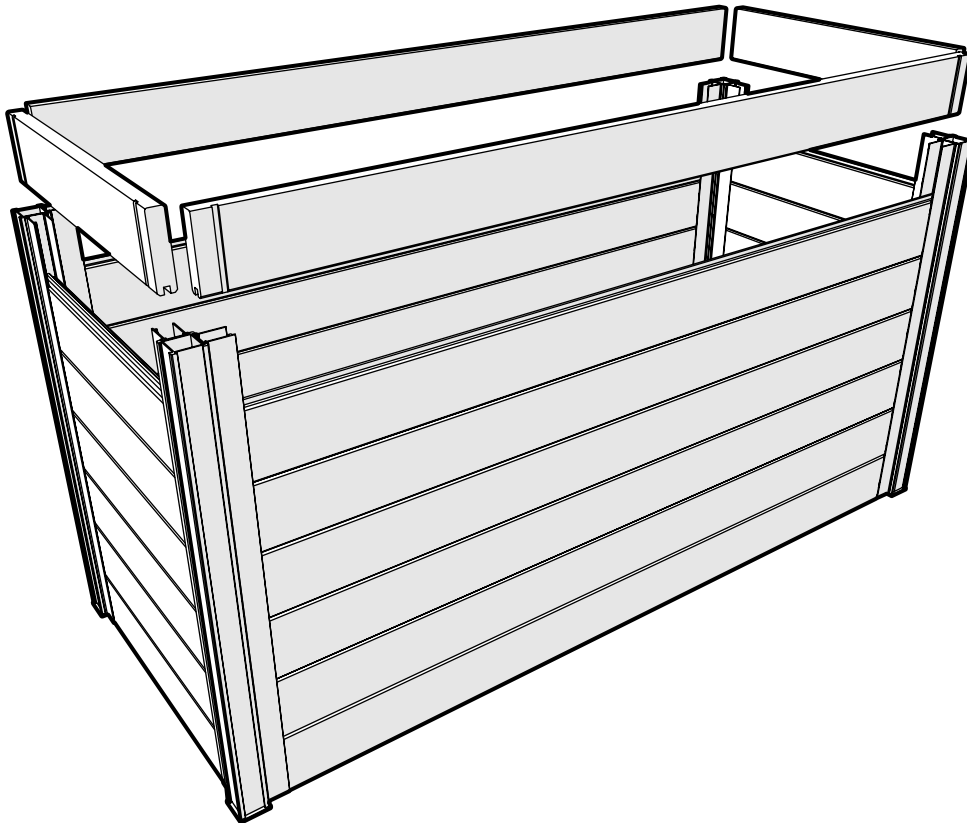

7

17047 - x2 (E) 

17048 - x10 (F) 

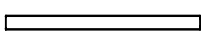
17049 - x1 (G) 

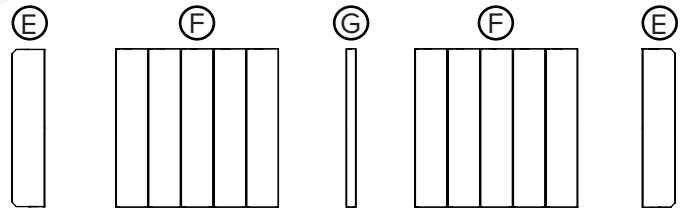
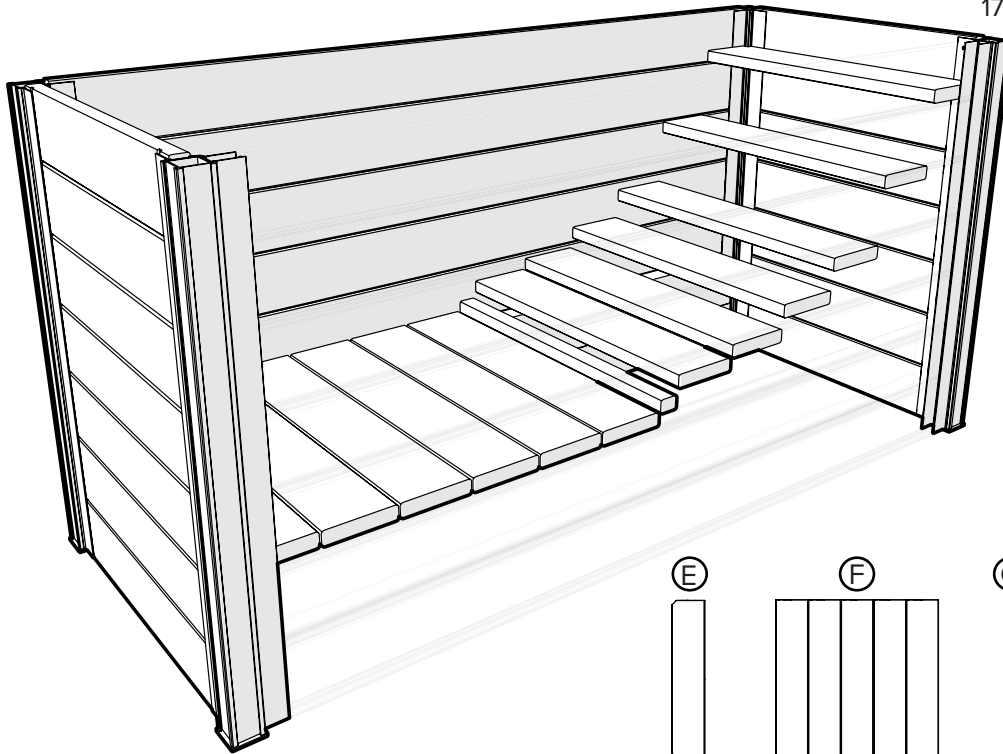

8

17020 - x4

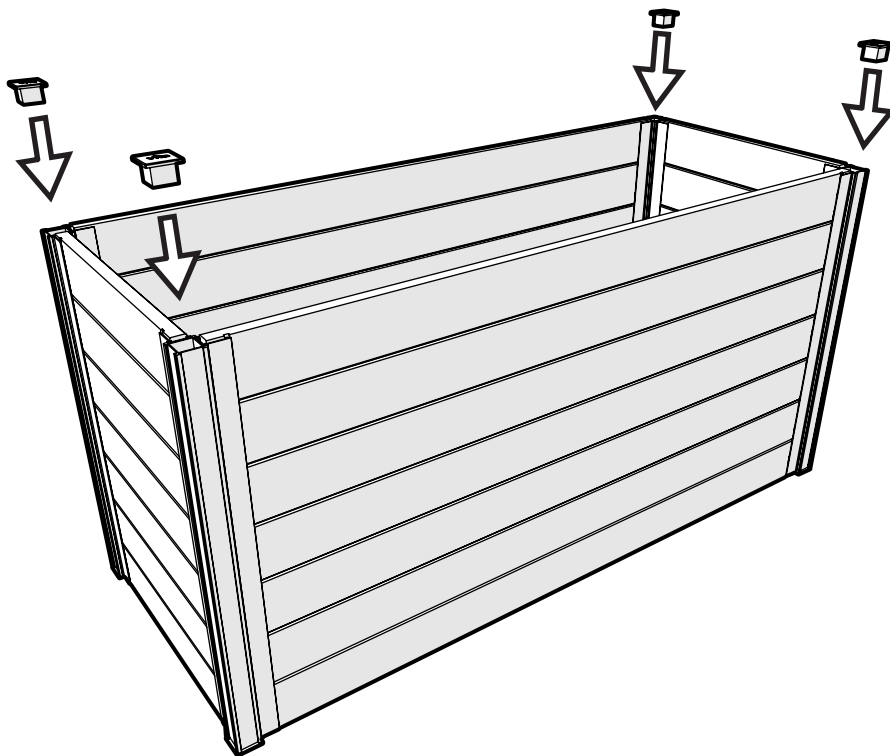
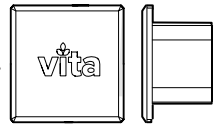

VT17716

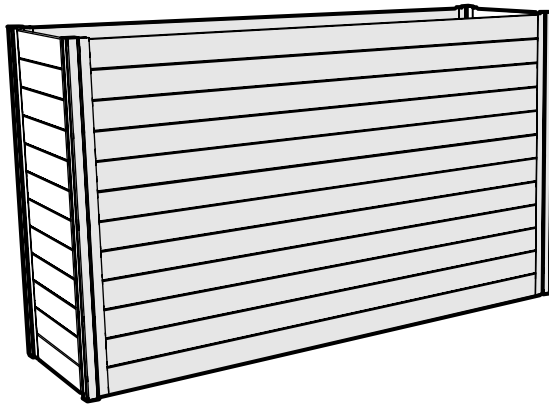

VT17715

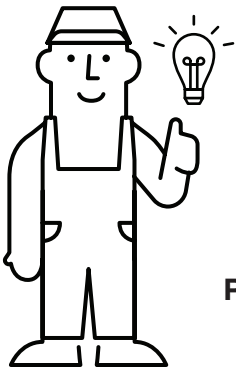
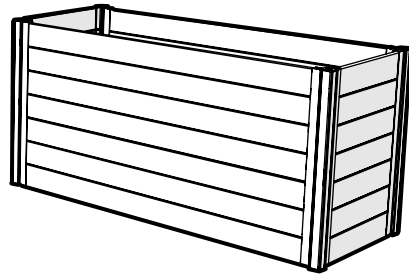

TRY COMBINING OUR PARKETTES TOGETHER AND CREATE YOUR OWN VARIATIONS TO SATISFY YOUR BACKYARD PLANTING NEEDS!

LE PLANCHER PEUT ÊTRE PLACÉ À LA POSITION QUI VOUS CONVIENT. SOUVENEZ-VOUS TOUTEFOIS QUE PLUS VOUS LE PLACEZ HAUT, PLUS VOUS RÉDUISEZ L'ESPACE NÉCESSAIRE POUR VOTRE TERREAU!

PUEDE COLOCAR EL SOPORTE DEL SUELO EN CUALQUIER POSICIÓN QUE DESEE. TENGA EN CUENTA QUE CUANTO MÁS ALTO LO UBIQUE, TENDRÁ MENOS ESPACIO PARA LA TIERRA

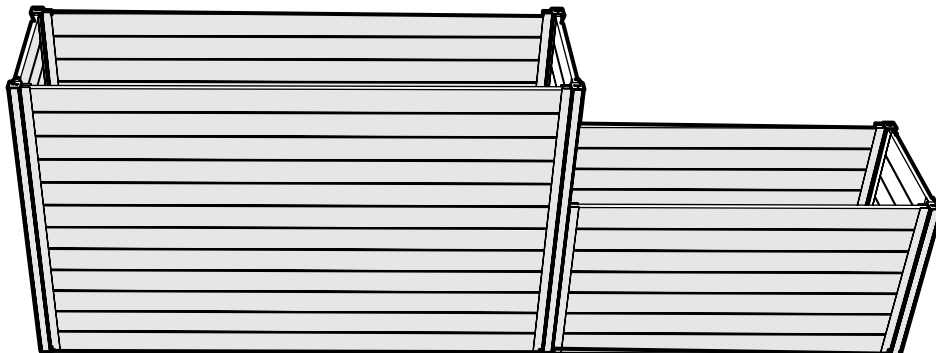
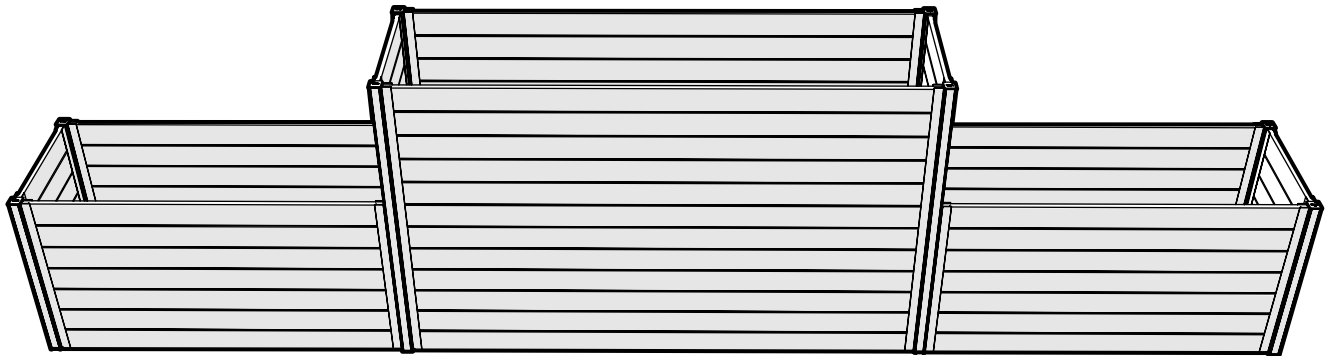

1

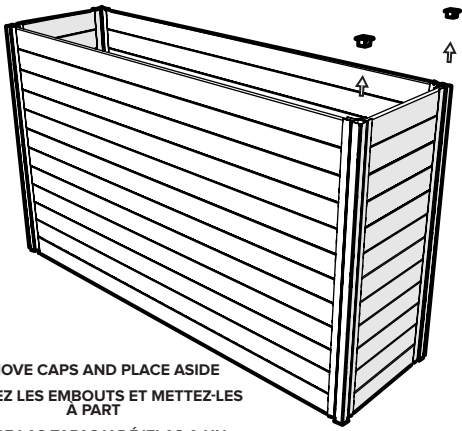

REMOVE CAPS AND PLACE ASIDE
 ENLEVEZ LES EMBOUTS ET METTEZ-LES
 A PART
 RETIRE LAS TAPAS Y DÉJELAS A UN
 LADO

2

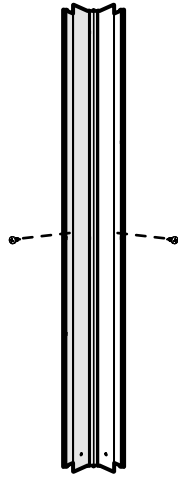

REMOVE SCREWS AND POST. KEEP BOTH
 C-CHANNELS AS YOU WILL BE USING THEM IN
 THE NEXT STEP.

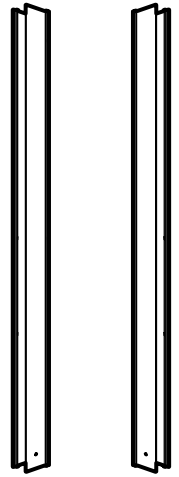

RETIREZ LES VIS ET LE MONTANT. CONSERVEZ
 LES DEUX CANAUX C TELS QUE VOUS LES
 UTILISEREZ À L'ÉTAPE SUIVANTE.

QUITE LOS TORNILLOS Y EL POSTE. MANTEN-
 GA AMBOS CANALES C, YA QUE LOS USARÁ
 EN EL SIGUIENTE PASO.

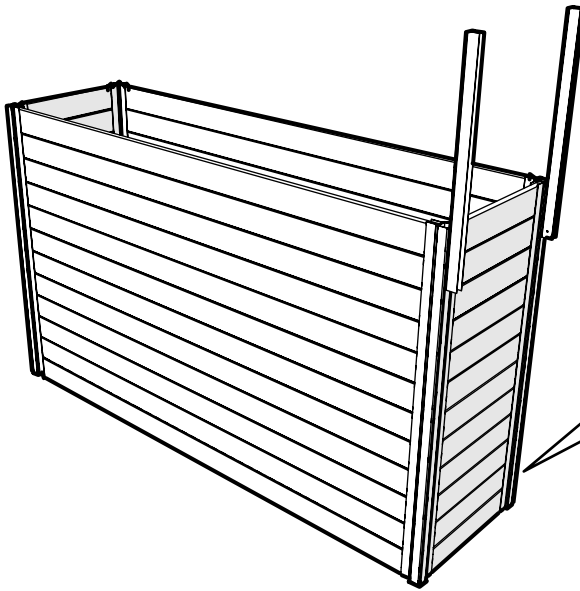

3



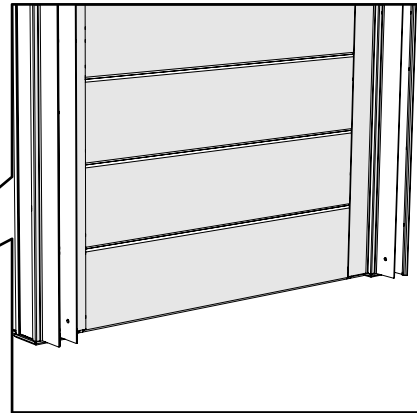

x2 
 x2 

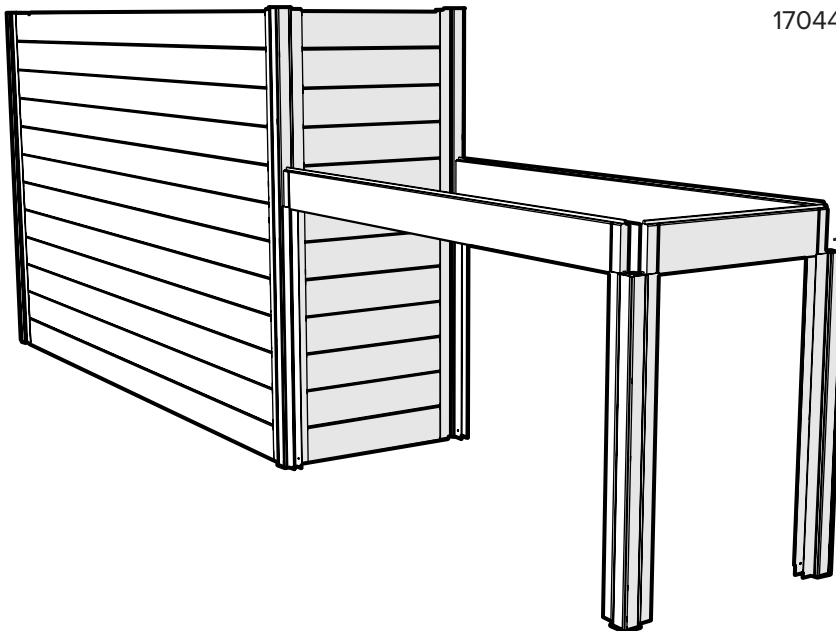

4

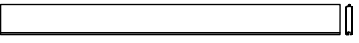

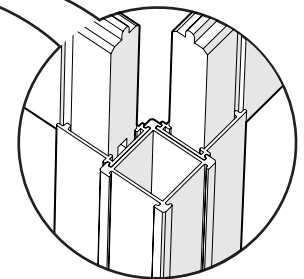

17041 - x2 
 17044 - x2 © 
 17045 - x1 ⓓ 

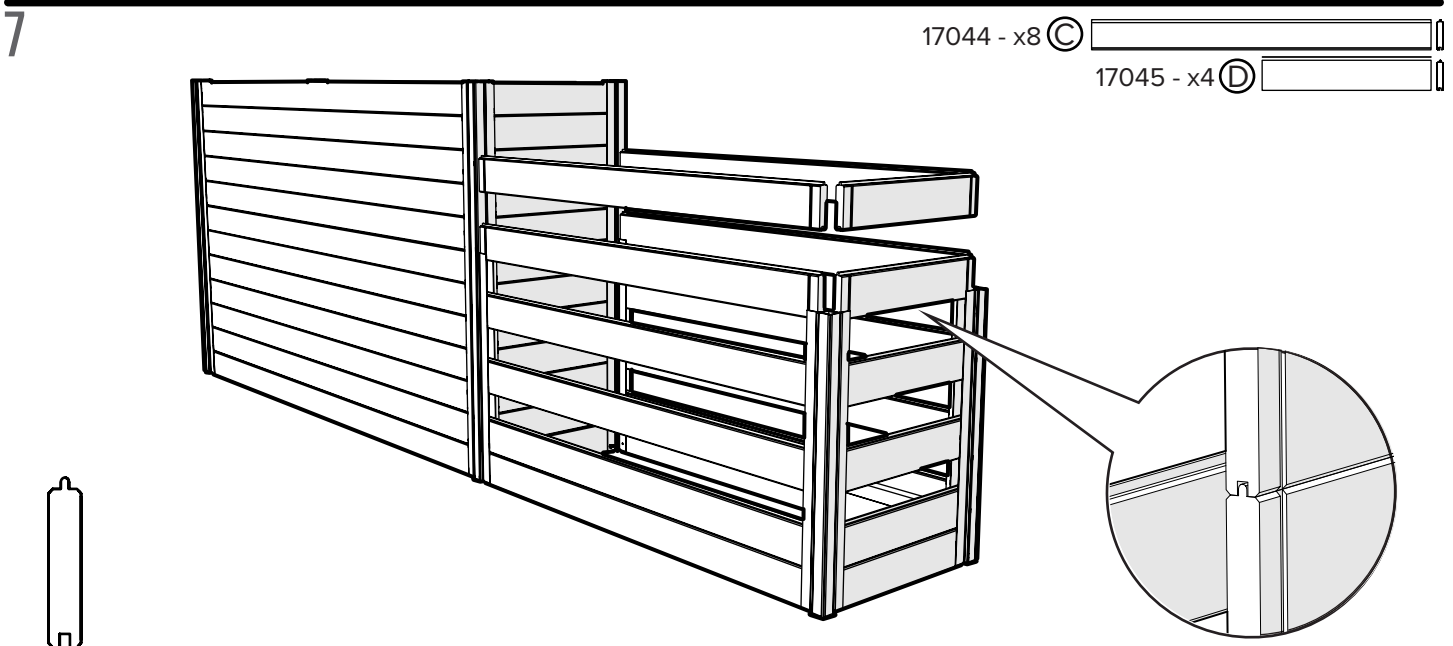
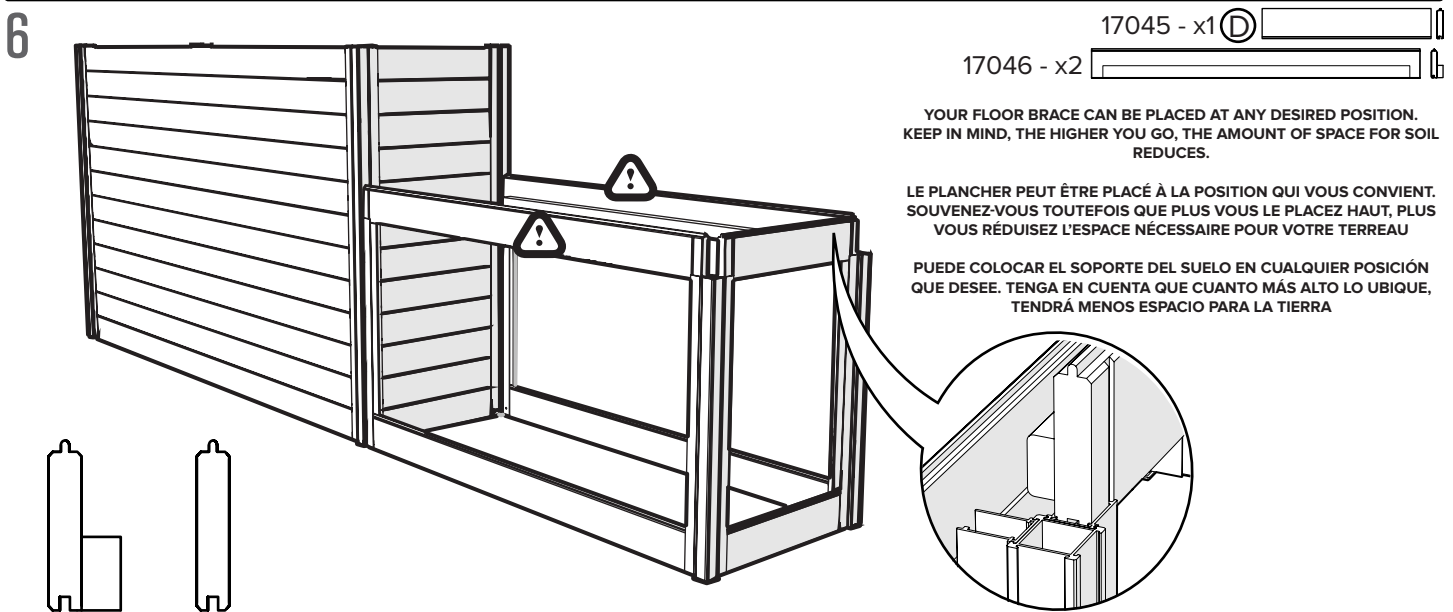
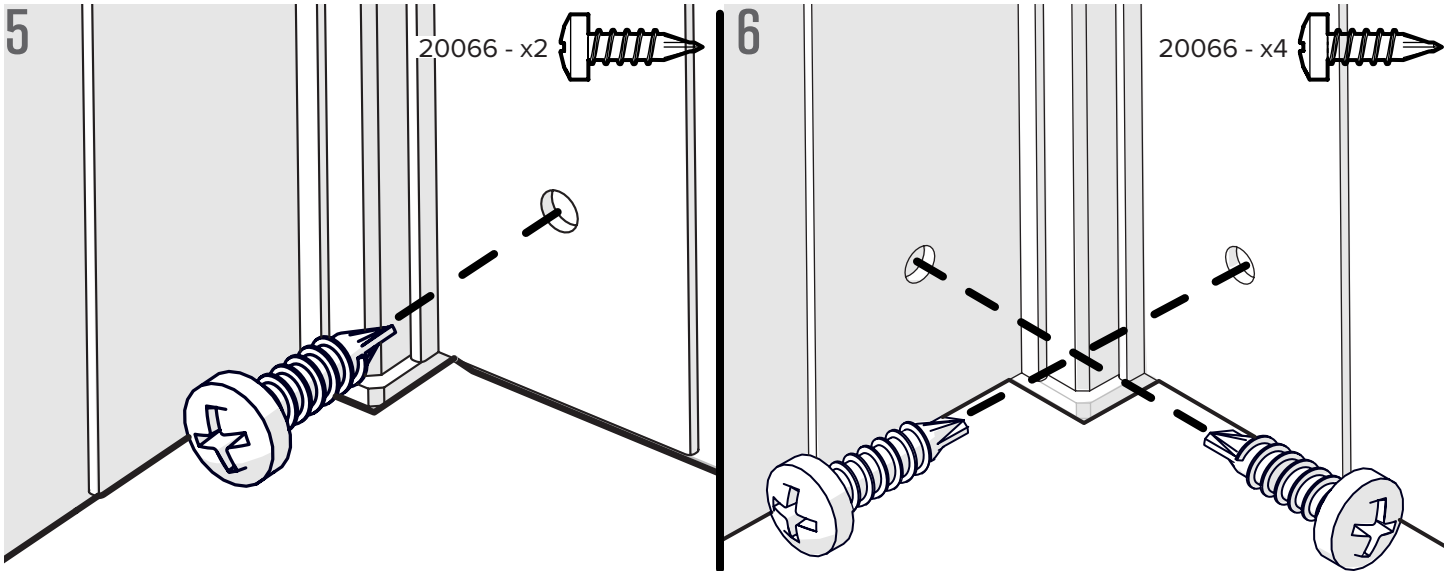



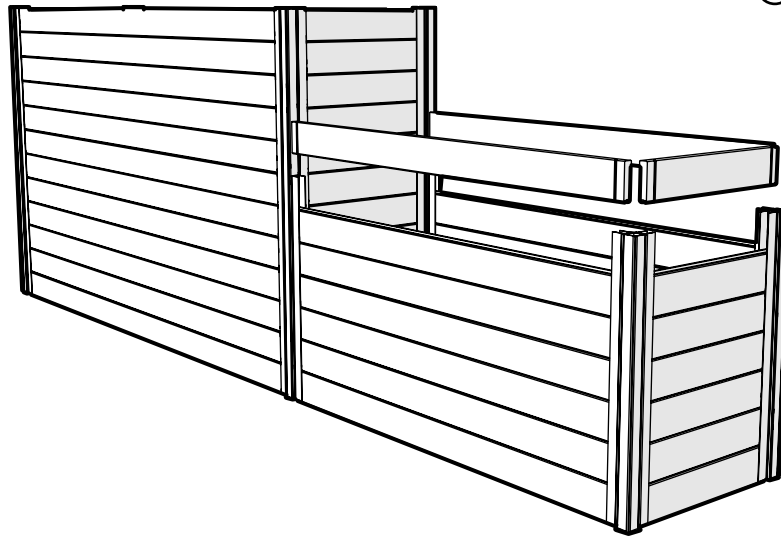

8

17042 - x2 (A) 
17043 - x1 (B) 

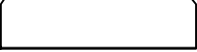

9

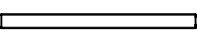
17047 - x2 (E) 
17048 - x10 (F) 
17049 - x1 (G) 

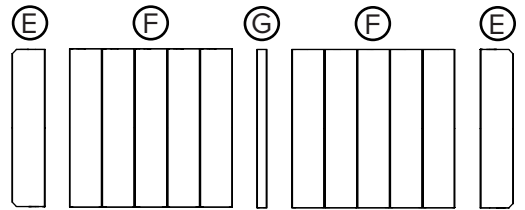
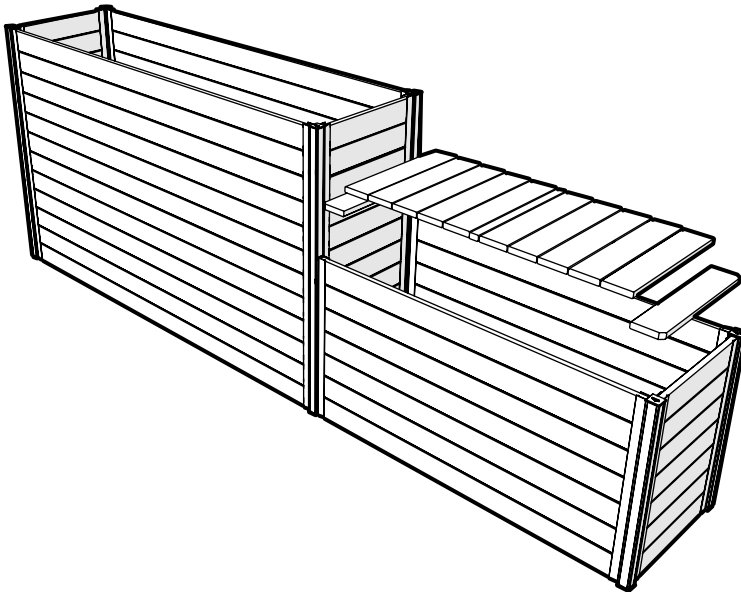

10

17020 - x4 

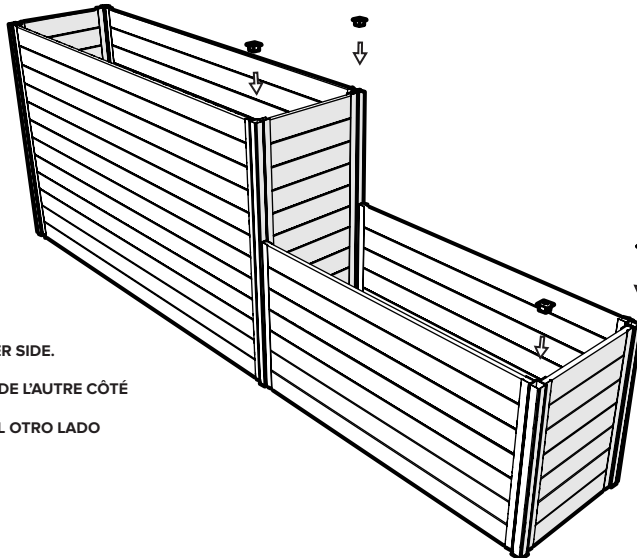

REPEAT STEPS TO BUILD ON THE OTHER SIDE.
RÉPÉTEZ LES ÉTAPES POUR LA CONSTRUCTION DE L'AUTRE CÔTÉ
REPITA LOS PASOS DE CONSTRUCCIÓN EN EL OTRO LADO

12