



**GAZEBO
PenGuin inc.**

4660 HICKMORE ST,
MONTREAL, QUEBEC
H4T 1K2
1-514-276-3485 / 1-800-737-7174
Email: customerservice@gazebopenguin.com

**PLEASE, READ
IN ITS ENTIRETY
BEFORE
INSTALLATION**

41218MR-12 SAND
41218MR-32 SLATE

**PLEASE, READ
IN ITS ENTIRETY
BEFORE
INSTALLATION**

**12 X 18 SOLARIUM
ASSEMBLY INSTRUCTIONS**

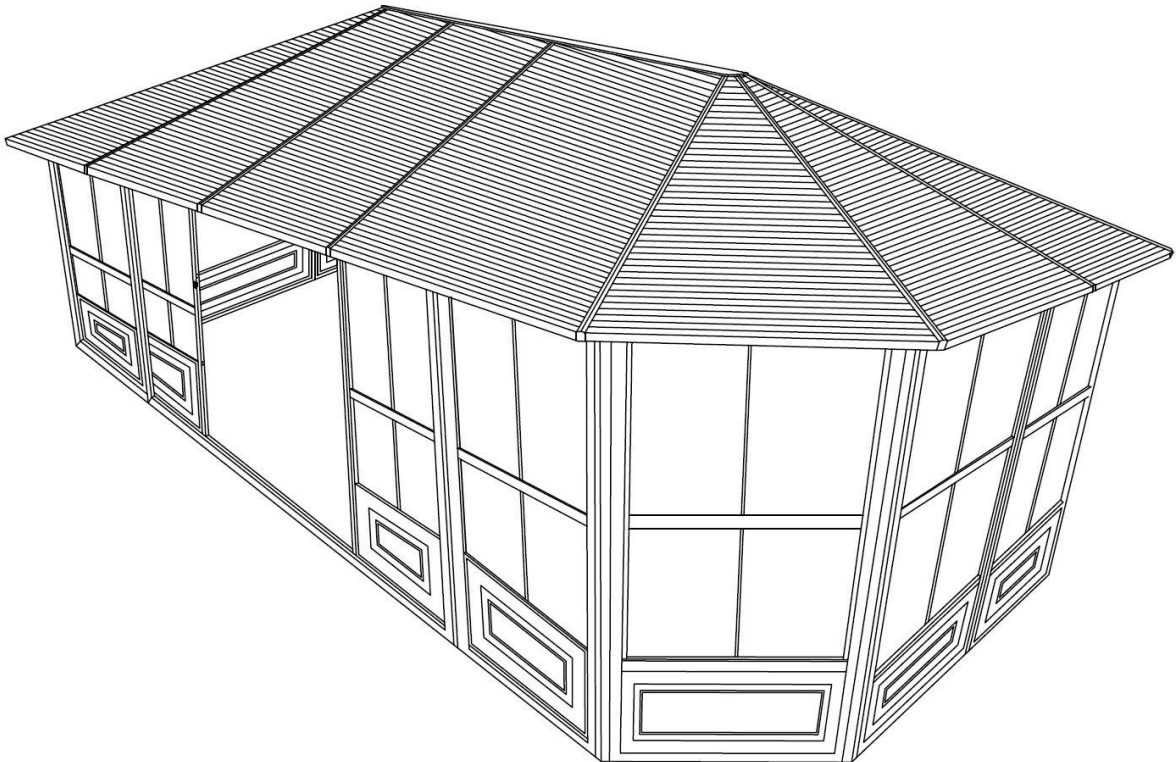

**DO NOT DESTROY THE BOXES UNTIL COMPLETELY ASSEMBLED
PLEASE VERIFY THE CONTENT OF EACH BOX AGAINST THE LIST OF PARTS**

Three adults required for assembly

Base Dimensions 12' 1/2"x18'11"
Largest Dimensions 12'10"x19'9"
Overall Height 110"

APPROX.

**DO NOT DESTROY THE BOXES UNTIL COMPLETELY ASSEMBLED
PLEASE VERIFY THE CONTENT OF EACH BOX AGAINST THE LIST OF PARTS**

12ft x 18ft / 3.66m x 5.49m Solarium

Instruction Manual

IMPORTANT: RETAIN FOR FUTURE REFERENCE, READ CAREFULLY

Consult with your local governing authority / local municipal codes regarding installation of temporary structures before purchase or assembly. Some jurisdictions may require permits for, or otherwise regulate, installation and use.

For assistance with assembly, installation, parts, or customer service, contact Gazebo Penguin Customer Service Department at the numbers listed below (English & French, Mon-Fri 8:00 AM to 4:00 PM EST):

Montreal: (514) 276-3485

Elsewhere in Canada and the US: 1-800-737-7174

WARNING:

- For outdoor use.
- Snow should be regularly cleared from the roof and not allowed to accumulate.
- Retain your **proof of purchase** for warranty purposes. Also keep the **original boxes** until the installation is complete and correct.
- The unit may take more than 4 hours and 3 people are required for this assembly.

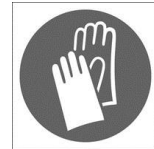

PRIOR TO ASSEMBLY:

- Please don't destroy boxes until completely assembled.
- The foundation must be level, flat, and solid, such as concrete or asphalt.
- Keep away from overhead utility lines, tree branches, and other structures.
- Check for underground pipes or wires if digging or drilling is required.
- Do not install near roof lines or other structures that could shed snow, ice, or excessive rain run-off onto the roof top.
- Assemble the structure as close to its final location as possible.
- It is recommended to wear safety gloves, safety glasses, and hard hats for installation.
- Do not hang from, climb on, or stand on the structure or roof.
- Before assembly, read instructions and check that all parts are present in the boxes. If any parts are missing, refer to warranty information.
- A 6ft (1.8m) stepladder, Phillips screwdriver, tape measure, level, mallet, and a tarp to place parts on will be required for assembly (not included).
- Remove top protective film from roof panels prior to assembly; **DO NOT** remove bottom protective film until ready to insert roof panels, so as to identify which side is on top.

ANCHORING INSTRUCTIONS:

- Proper anchoring of the frame to the base and the wall is required for safety.
- Any structure not anchored securely has the potential to fly away during high wind causing damage and safety hazard.
- How the item is anchored, and the hardware and tools required, will vary based upon the set up location and are not provided.
- Please check with your local hardware store if for the appropriate anchors for your surface.
- Do not anchor to pavers / pavement slabs because they are not a solid foundation.
- Periodically check the anchors to ensure they remain secure

CARE AND MAINTENANCE:

- In case of a defective or damaged part, or for any other questions concerning the product, please contact the manufacturer directly.
- Please have the parts list and part numbers on hand when ordering or requesting replacement parts.

ROOF PANELS:

- Gently clean with an environmentally-friendly soap solution and water using a sponge or washcloth.
- Do not use abrasive materials, wire brushes, chemicals, harsh cleaners, or bleach.
- Rinse using a garden hose and air dry. If removed, ensure thoroughly dry prior to storage.
- Do not use pressure washer.

STRUCTURE:

- Gently clean with an environmentally-friendly soap solution and water using a sponge or washcloth.
- Do not use abrasive materials, wire brushes, chemicals, harsh cleaners, or bleach.
- Rinse using a garden hose and air dry.
- Do not use pressure washer.
- If there are nicks, chips, and/or scratches see the part # of the paint in the parts list to obtain a matching touch-up paint.

MAINTENANCE NOTES

1. In case of a defective or damaged part, or for any other questions concerning the product, please contact the manufacturer directly.
2. Please have the parts list and part numbers on hand when ordering or requesting replacement parts.
3. The product should not be installed adjacent to trees or a sloped roof. Snow and ice may slide onto the roof and cause it to collapse.
4. While the product is designed to stay assembled year long, the roof must be kept free of accumulation of snow.



ONE YEAR LIMITED WARRANTY

This product has been designed and manufactured to meet the highest standards of quality and durability. Subject to the Conditions for Exercising the Warranty and the Limitations on the Warranty set forth below, it is warranted to be free of material and manufacturing defects for a period of **one year** from the date of purchase. Missing and damage due to transportation is not covered by the manufacture warranty. Should the product become damaged, or the warranty period has expired, please contact Gazebo Penguin Customer Service Department for a complete schedule of replacement parts and prices.

CONDITIONS FOR EXERCISING THE WARRANTY

The warranty only applies to the original purchaser with the bill.

In order to properly exercise your warranty, please comply with the following:

Carefully inspect the contents of the carton for missing or damaged components. Should you discover damaged or missing parts, **do not return the product to the place of purchase**, but contact Gazebo Penguin Customer Service Department at the numbers listed below:

Montreal: (514) 276-3485

Elsewhere: 1-800-737-7174

You can also find a claim form to fill out online:

<https://abrispenguin.com/assemblyinstructions/>









NOTE: Damages/missing parts must be reported within 30 days of delivery. If claimed after your request might be rejected.

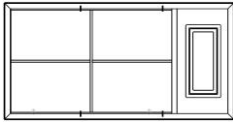
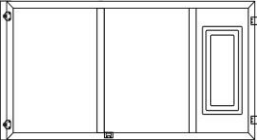

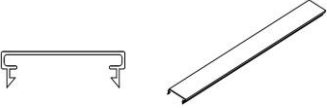
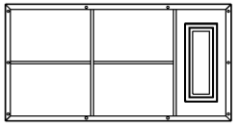
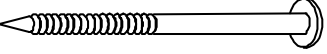

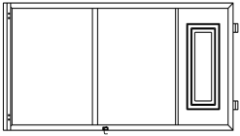

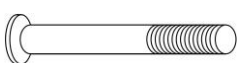

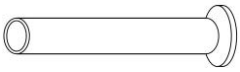
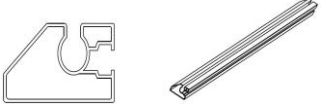

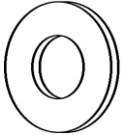
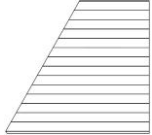
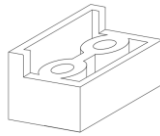
LIMITATIONS ON THE WARRANTY

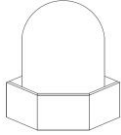
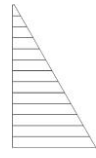

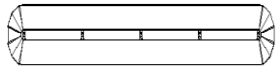

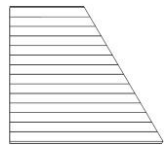

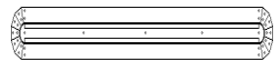
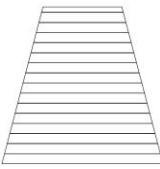
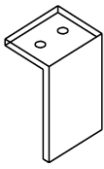

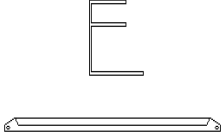
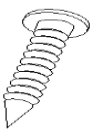

1. The product is not warranted against damages due to vandalism, abuse, falling or thrown objects, or accumulation of snow.
2. The product is not warranted against damages due to extreme weather conditions, such as thunderstorms, hail, strong wind or snow storms, or any other acts of God.
3. Leaking due to heavy rain may happen, please refer to the instruction manual for window positions and information on how to evacuate the water.
4. The product is only warranted in the event it is installed in accordance with the Gazebo Penguin's written instructions enclosed with the product.
5. The product is not warranted in the event it has been improperly anchored.
6. We reserve the right to replace or repair any defective product or parts at our discretion.
7. No change to the unit is allowed. This will void your warranty.

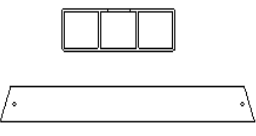

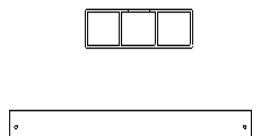
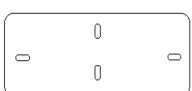
41218 SAND

(See page 8 for Slate parts)

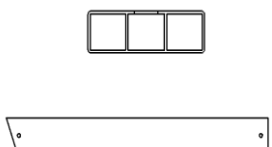

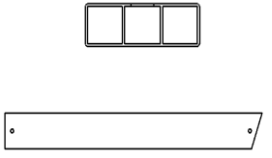

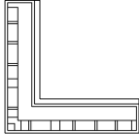
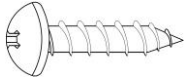
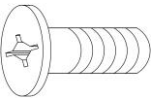
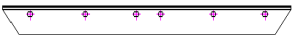
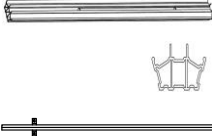
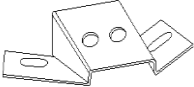
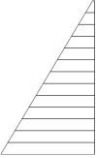
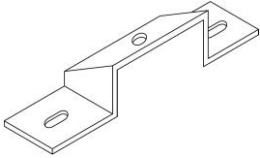

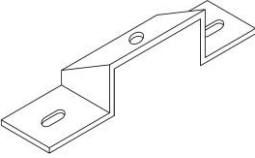

DESCRIPTION	PACKED IN BOX	QTY	DRAWING	DESCRIPTION	PACKED IN BOX	QTY	DRAWING
08-129-12 REGULAR FRAME A	2	4		08-160-12 SLIDING DOOR WITH RECEIVER CHANNEL D	2	1	
	3	8					
17-054-12 ROOF PANEL Aa	6	4		08-133-12 CONNECTING PIECE 78.9" E	4	14	
08-130-12 FRAME NEXT TO DOORS (extra holes) B	2	2		08-167-12 SCREW M6*63.5 Ee	1	28	
08-158-12 SCREW M6*16 Bb	1	140		08-162-12 TOP DOOR RAIL LEFT 81.9" F	4	1	
08-159-12 SLIDING DOOR - REGULAR C	2	1		08-221-12 TOP DOOR RAIL RIGHT 81.9" F1	4	1	
08-161-12 SCREW M6X70 Cc	1	12		08-163-12 BOTTOM DOOR RAIL LEFT 81.9" G	4	1	
12-037-12 CAPNUT M5X60 Cc-2	1	12		08-220-12 BOTTOM DOOR RAIL RIGHT 81.9" G1	4	1	

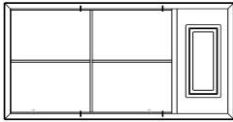
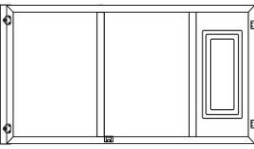

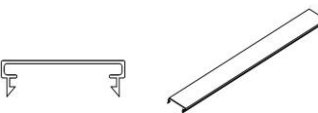
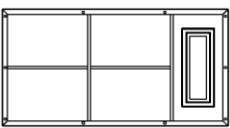
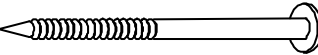
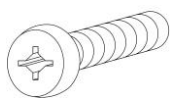

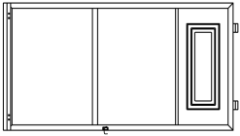

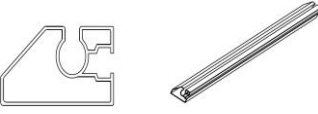

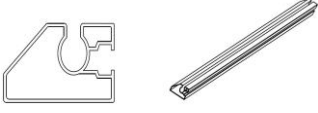

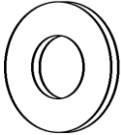
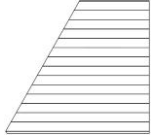
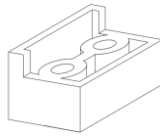
DESCRIPTION	PACKED IN BOX	QTY	DRAWING	DESCRIPTION	PACKED IN BOX	QTY	DRAWING
08-187-12 WASHER Gg	1	45		17-061-12 ROOF PANEL Kk	5	4	
08-138-12 DOOR STOPPER H	1	2		17-044-12 RAFTER 78.9" L	4	7	
08-189-12 ACORN NUT Hh	1	5		17-057-12 ROOF PANEL LI	6	4	
08-139-12 CONNECTING PIECE 78.9" I	4	8		08-164-12 TOP CAP M	4	1	
08-193-12 PLASTIC PLUG li	1	28		17-058-12 ROOF PANEL Mm	5	4	
08-140-12 CONNECTING PIECE 78.9" J	4	8		08-166-12 CENTRAL HUB N	4	1	
17-055-12 ROOF PANEL Jj	5	4		08-134-12 UPPER DOOR RAIL END CAP Nn	1	2	
17-043-12 RAFTER 89.9" K	4	8		17-049-12 COVER FOR RAFTER 88.9" O	4	8	

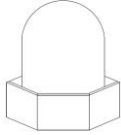
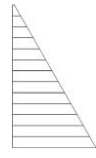

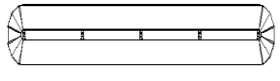

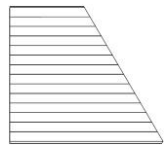

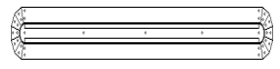
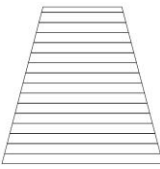
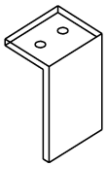
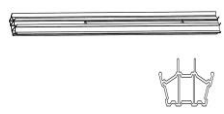

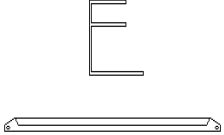
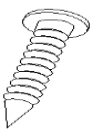

DESCRIPTION	PACKED IN BOX	QTY	DRAWING	DESCRIPTION	PACKED IN BOX	QTY	DRAWING
17-050-12 COVER FOR RAFTER 78.5" O1	4	8		17-046-12 FINISHING BAR 45.3" S	1	4	
08-135-12 SCREW Oo	1	4		17-068-12 FINISHING BAR 42.6" Ss	1	4	
16-118-12 SCREW M6 X 36 Oo1	1	64		17-048-12 SOLIDIFYING BAR 20.8" T	1	4	
17-051-12 GAP COVER BAR 39.7" P	1	16		17-069-12 SOLIDIFYING BAR 39.4" Tt	1	4	
18-067-12 SOLIDIFYING BAR BRACKET Pp	1	16		17-045-12 FINISHING BAR 45.2" U	1	4	
17-075-12 ROOF PANEL Qq	7	4		17-071-12 FINISHING BAR 45.2" U1	1	4	
17-053-12 END CAP R	1	16		17-047-12 SOLIDIFYING BAR 20.8" V	1	4	
17-076-12 ROOF PANEL Rr	7	4		17-070-32 SOLIDIFYING BAR 20.8" V1	1	4	

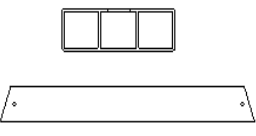

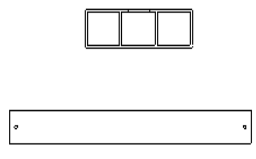
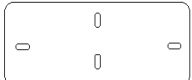
DESCRIPTION	PACKED IN BOX	QTY	DRAWING	DESCRIPTION	PACKED IN BOX	QTY	DRAWING
11-599-12 CORNER KEY Vv (Installed in Yy)	2	4		08-156-12 SCREW M4 X 16 Z	1	64	
12-047-12 SCREW M5 X 15 Ww	1	12		11-598-12 HORIZONTAL BAR FOR DOOR FRAME 81.1" Zz	2	2	
17-072-12 MIDDLE DOOR ROOF RAFTER 78.9" Xx	4	1		15-124-12 STEEL ANGLE Z1 (assembled on rafter K)	4	8	
17-060-12 ROOF PANEL Y	6	4		15-125-12 STEEL ANGLE Z2 (assembled on rafter L)	4	7	
11-597-12 VERTICAL BAR DOOR FRAME 78.7" Yy	2	2		19-102-12 STEEL ANGLE Z3 (assembled on rafter Xx)	4	1	
*NOT INCLUDED IN THE BOX							
DESCRIPTION	COLOUR	PART #					
SPRAY PAINT	SAND	11-699					
PAINT PEN		18-245					

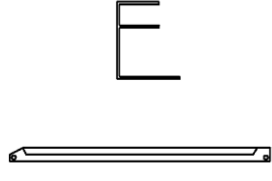
41218 SLATE

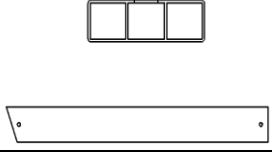
DESCRIPTION	PACKED IN BOX	QTY	DRAWING	DESCRIPTION	PACKED IN BOX	QTY	DRAWING
08-129-32 REGULAR FRAME A	2	4		08-160-32 SLIDING DOOR WITH RECEIVER CHANNEL D	2	1	
	3	8					
17-054-32 ROOF PANEL Aa	6	4		08-133-32 CONNECTING PIECE 78.9" E	4	14	
08-130-32 FRAME NEXT TO DOORS (extra holes) B	2	2		08-167-32 SCREW M6*63.5 Ee	1	28	
08-158-32 SCREW M6*16 Bb	1	140		08-162-32 TOP DOOR RAIL LEFT 81.9" F	4	1	
08-159-32 SLIDING DOOR- REGULAR C	2	1		08-221-32 TOP DOOR RAIL RIGHT 81.9" F1	4	1	
08-161-32 SCREW M6X70 Cc	1	12		08-163-32 BOTTOM DOOR RAIL LEFT 81.9" G	4	1	
12-037-32 CAPNUT M5X60 Cc-2	1	12		08-220-32 BOTTOM DOOR RAIL RIGHT 81.9" G1	4	1	

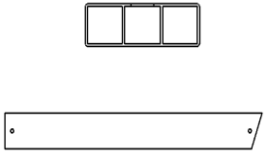
DESCRIPTION	PACKED IN BOX	QTY	DRAWING	DESCRIPTION	PACKED IN BOX	QTY	DRAWING
08-187-32 WASHER Gg	1	45		17-061-32 ROOF PANEL Kk	5	4	
08-138-32 DOOR STOPPER H	1	2		17-044-32 RAFTER 78.9" L	4	7	
08-189-32 ACORN NUT Hh	1	5		17-057-32 ROOF PANEL LI	6	4	
08-139-32 CONNECTING PIECE 78.9" I	4	8		08-164-32 TOP CAP M	4	1	
08-193 PLASTIC PLUG Ii	1	28		17-058-32 ROOF PANEL Mm	5	4	
08-140-32 CONNECTING PIECE 78.9" J	4	8		08-166-32 CENTRAL HUB N	4	1	
17-055-32 ROOF PANEL Jj	5	4		08-134-32 UPPER DOOR RAIL END CAP Nn	1	2	
17-043-32 RAFTER 89.9" K	4	8		17-049-32 COVER FOR RAFTER 88.9" O	4	8	

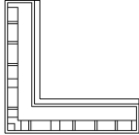
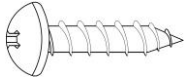
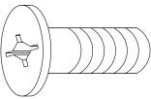
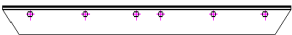
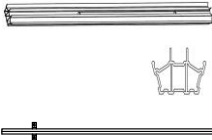
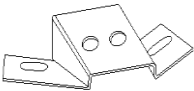
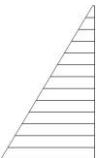
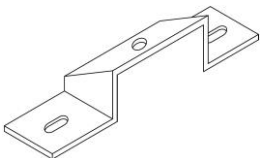
DESCRIPTION	PACKED IN BOX	QTY	DRAWING	DESCRIPTION	PACKED IN BOX	QTY	DRAWING
17-050-32 COVER FOR RAFTER 78.5" O1	4	8		17-046-32 FINISHING BAR 45.3" S	1	4	
08-135-32 SCREW Oo	1	4		17-068-32 FINISHING BAR 42.6" Ss	1	4	
16-118-32 SCREW M6 X 36 Oo1	1	64		17-048-32 SOLIDIFYING BAR 20.8" T	1	4	
17-051-32 GAP COVER BAR 39.7" P	1	16		17-069-32 SOLIDIFYING BAR 39.4" Tt	1	4	
18-067-32 SOLIDIFYING BAR BRACKET Pp	1	16		17-045-32 FINISHING BAR 45.2" U	1	4	
17-075-32 ROOF PANEL Qq	7	4		17-071-32 FINISHING BAR 45.2" U1	1	4	
17-053-32 END CAP R	1	16		17-047-32 SOLIDIFYING BAR 20.8" V	1	4	
17-076-32 ROOF PANEL Rr	7	4		17-070-32 SOLIDIFYING BAR 20.8" V1	1	4	

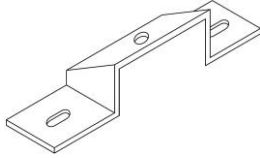
DESCRIPTION	PACKED IN BOX	QTY	DRAWING	DESCRIPTION	PACKED IN BOX	QTY	DRAWING
11-599-32 CORNER KEY Vv (Installed in Yy)	2	4		08-156-32 SCREW M4 X 16 Z	1	64	
12-047-32 SCREW M5 X 15 Ww	1	12		11-598-32 HORIZONTAL BAR FOR DOOR FRAME 81.1" Zz	2	2	
17-072-32 MIDDLE DOOR ROOF RAFTER 78.9" Xx	4	1		15-124-32 STEEL ANGLE Z1 (assembled on rafter K)	4	8	
17-060-32 ROOF PANEL Y	6	4		15-125-32 STEEL ANGLE Z2 (assembled on rafter L)	4	7	
11-597-32 VERTICAL BAR DOOR FRAME 78.7" Yy	2	2		19-102-32 STEEL ANGLE Z3 (assembled on rafter Xx)	4	1	
*NOT INCLUDED IN THE BOX							
DESCRIPTION	COLOUR	PART #					
SPRAY PAINT	SLATE	18-125					
PAINT PEN		18-126					

Before you assemble the Solarium

PLEASE DON'T DESTROY BOXES UNTIL COMPLETELY ASSEMBLED

Tools needed:

- Step Ladder 6' – 8'
- #2 Phillips Screwdriver, Robertson #2 (not supplied)
- Rubber Mallet
- Various Files
- 12" piece of wood

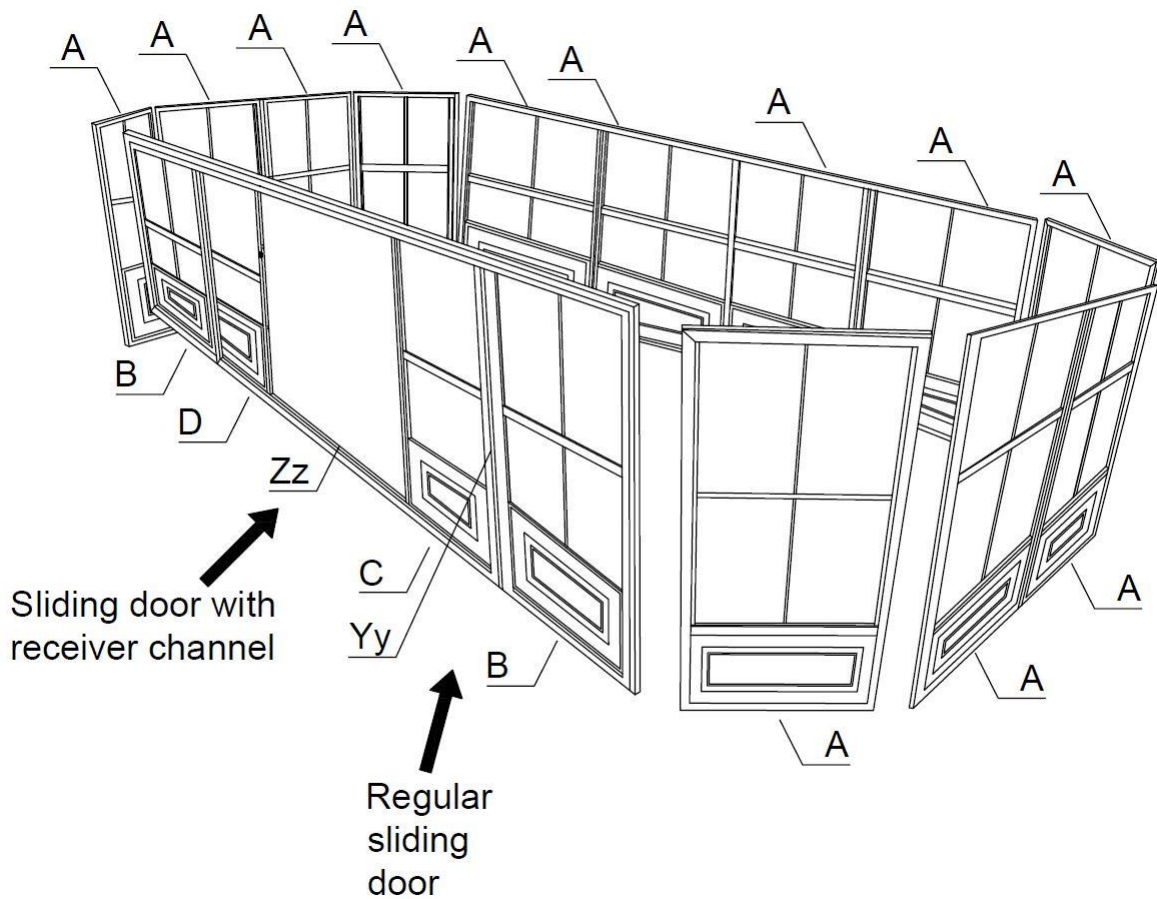

Based on the location, decide where you would like to position the two (2) doors panels which can slide open to the left or the right, your choice.

Assembly Instructions

12x18 Solarium

Pre-assembled steel angle (Z1, Z2, and Z3) to roof Rafters (K, L, Xx) respectively using Bolts (Bb)

To Be Assembled Before Packing

4 Steel Angles (Z1) to be attached to the right hole and remaining 4 to the left hole.

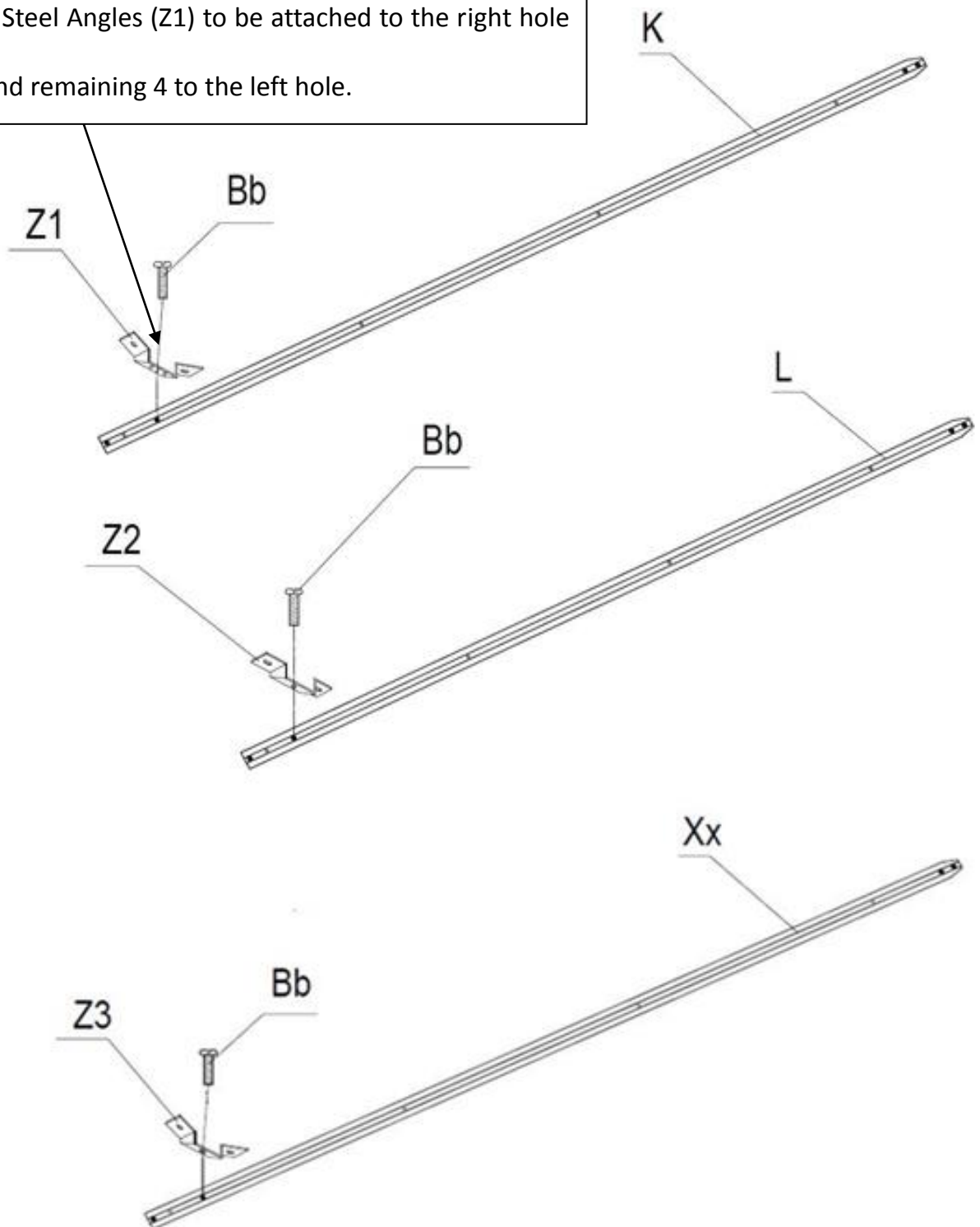

Step 1:

Before starting to assemble, please decide where you would like to position the door panels.

1. Stand up two Regular Frames (A) and affix the panels together at an angle by sliding two connecting Pieces (I, J) from top to bottom. All Frames should be placed such that screening face out of the unit.
2. To assemble door frame, firstly assemble 2 vertical bars (Yy) with 2 horizontal bars (Zz). Make sure the shape of the aluminum matches the other parts to be joined. With a rubber mallet get them closed at the corners. Make sure to not damage the aluminum parts. Make a small pilot hole if necessary, under 1/8" and use screws (Z) to secure 4 corners manually, screwing all screws into frame 4 holes.
3. After assembling door frame, attach to frames (B) on either side, by sliding connecting piece (E) between the frame and the door frame.
4. When assembling angled panels (A, B), you should put the two panels at 135-degree angle then use the angled connecting pieces (I) and (J) to affix the panels together.
5. Door frame step down is on the inside of the unit.

Note:

1. When sliding the part I, J and E into the frames shake the frames for it too slide. Do not apply excess force. Make sure the edges are clean from any extra paint if necessary, use a fine file.
2. Make sure the floor is level if not use Leveling Shims.

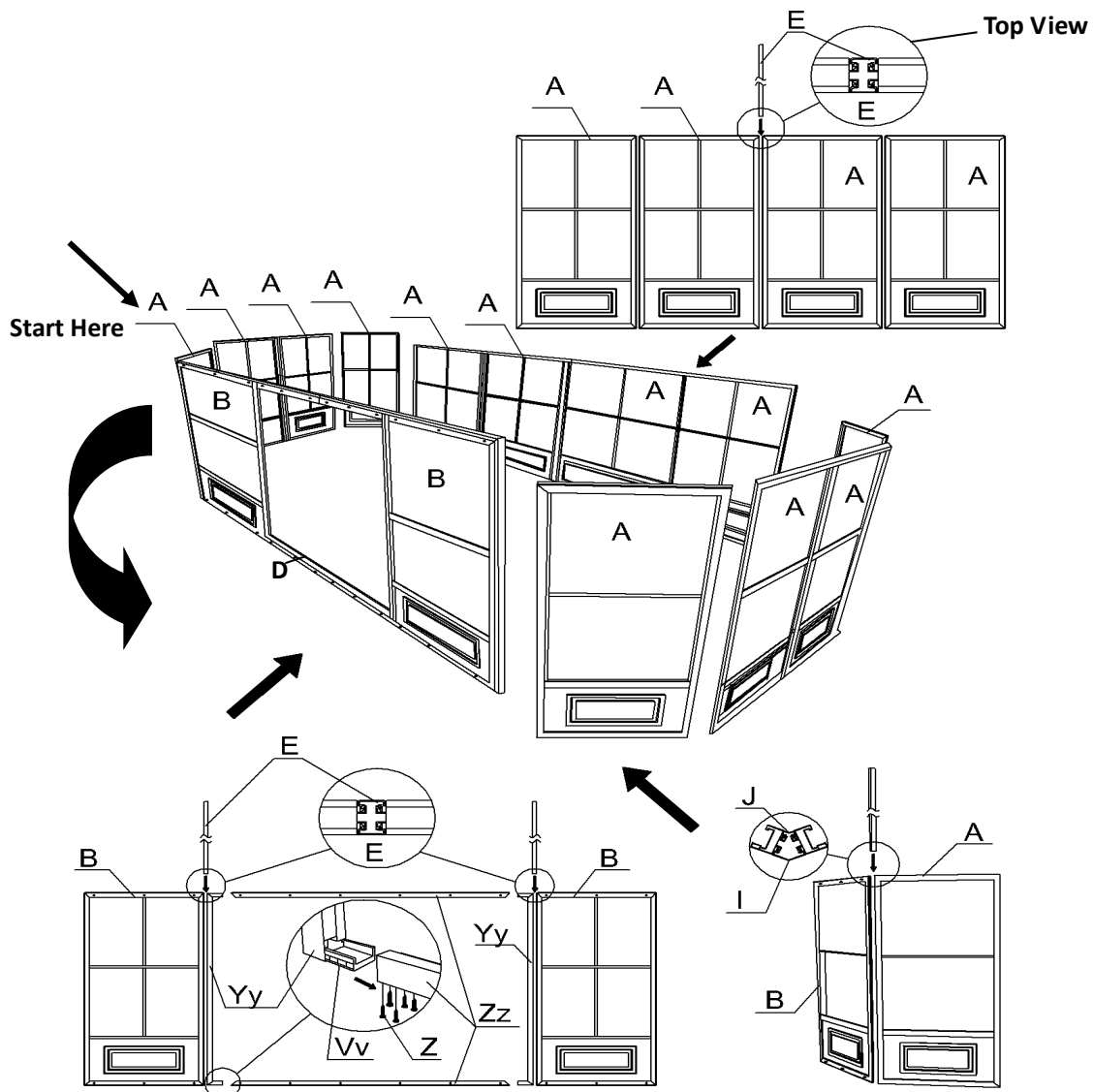

Step 2:

1. Affix gap Cover Bars (P) by sliding them on the top of the exterior groove of the Regular Frames (A, B, D).

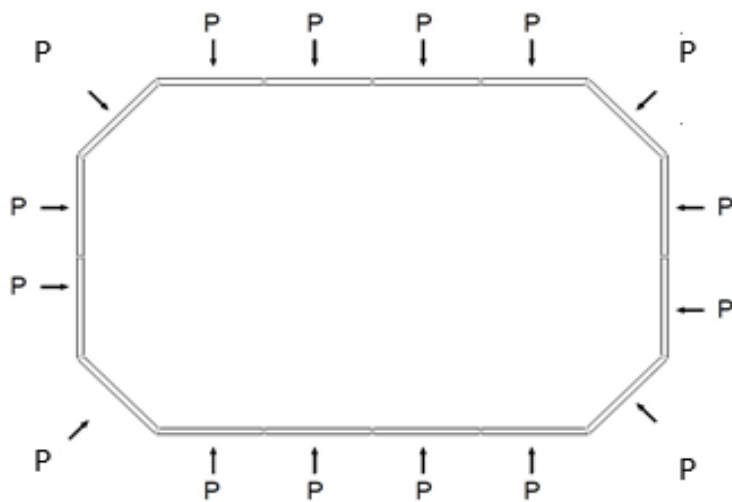
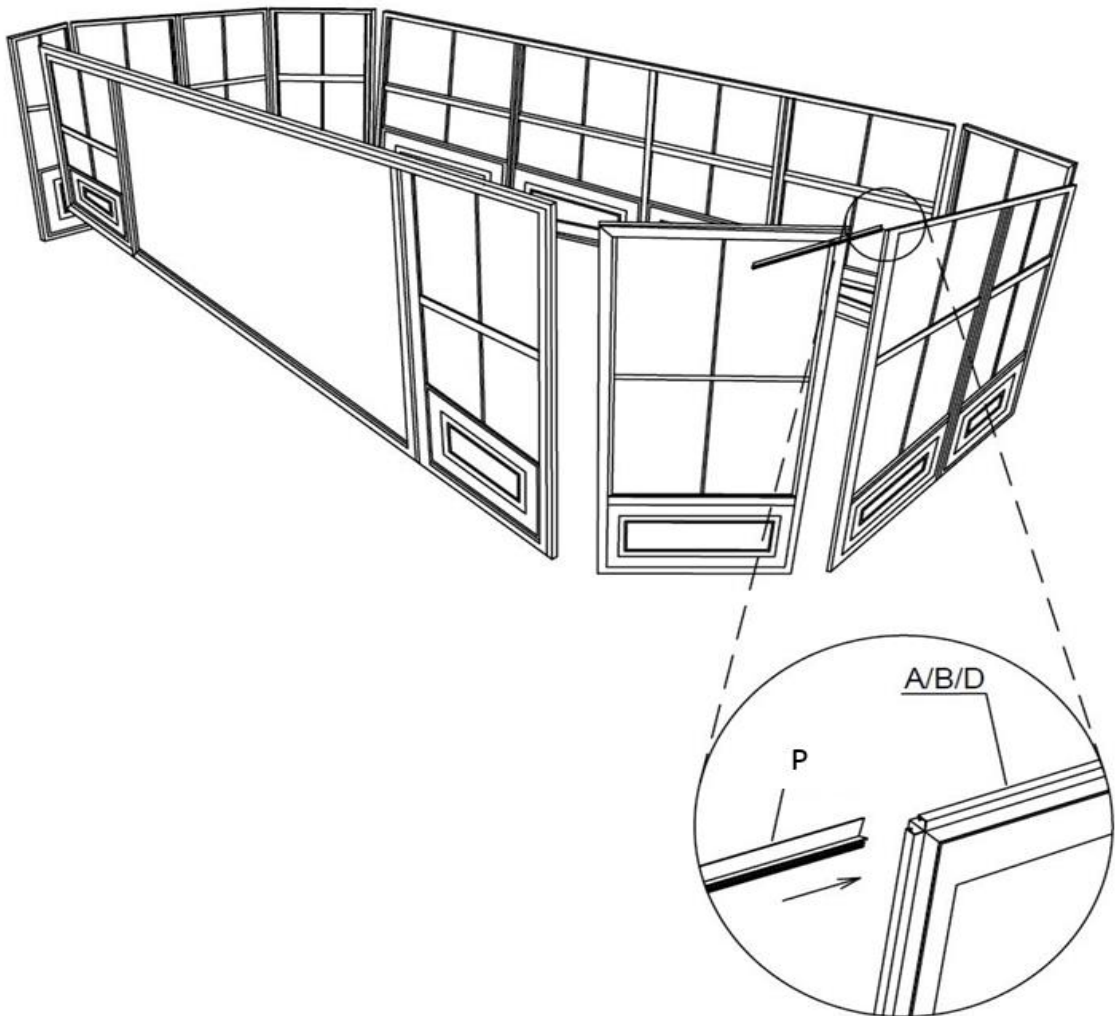

Step 3:

1. Slide Top Door Rail (F) into wheels of Sliding Door (C).
2. Slide Lower Door Rail (G) into the plastic guide of the Sliding Door (C).
3. Use Bolts (Bb) to affix the Plastic Stoppers (H) one on each end of Top Door Rail (F).
4. Using a Screw (Oo) affix the upper door rail End Caps (Nn) one on each end of Top Door Rail (F).
5. Similarly follow the above step to assemble the Sliding Door (D).

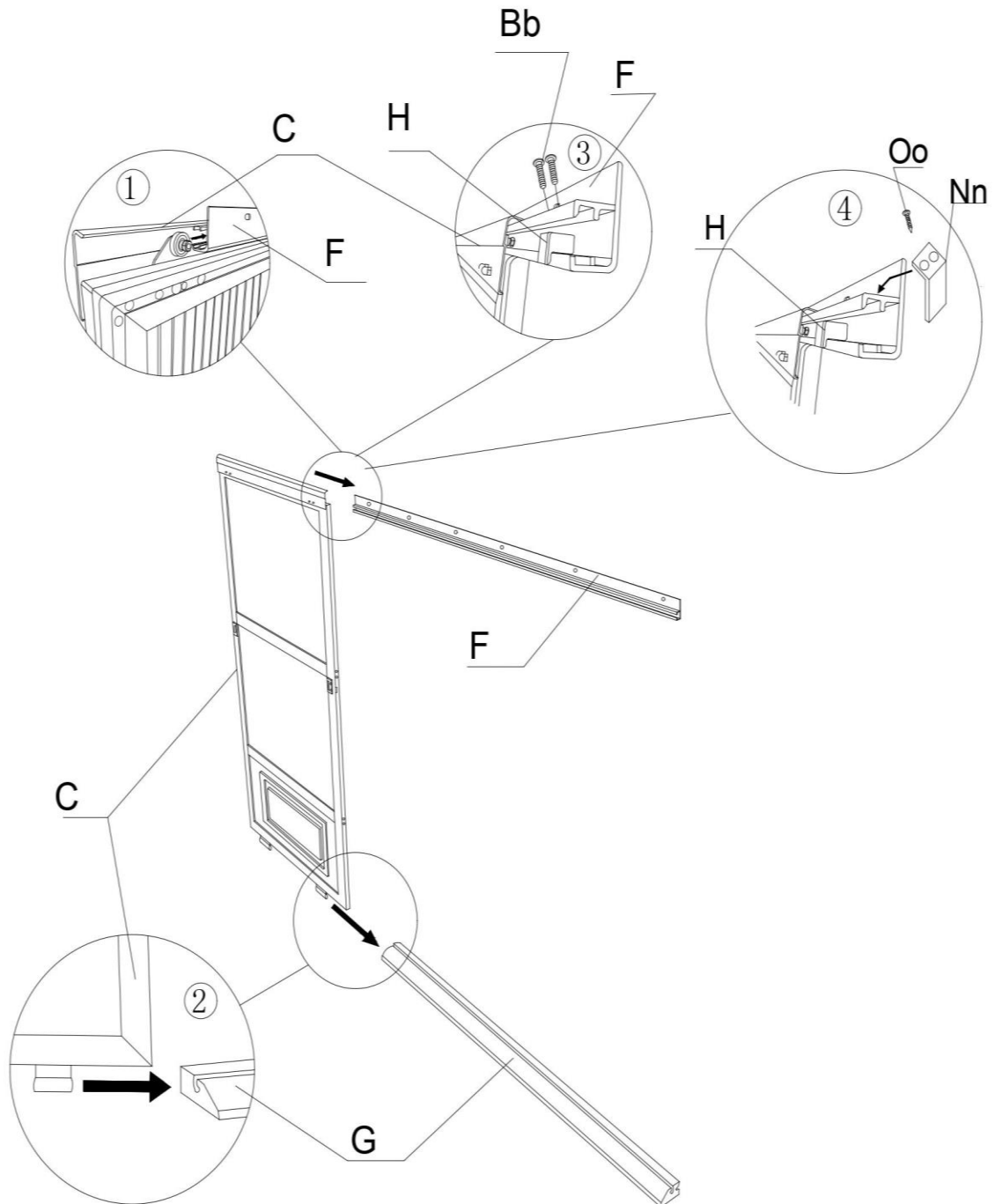

Step 4:

Please note the sliding door is suggested to be installed from the inside of the solarium.

1. Place a Bolt (Ww) and Washer (Gg) through the Top of Sliding Door Frame (C) and Top Door Rail (F), and place a Female Bolt (Cc-2) from the other side. Once all are inserted, tighten them all securely.
2. Secure the Bottom Door Rail (G), using a Bolt (Cc) with a Washer (Gg).
3. Similarly follow the above step for Sliding Door (D) with Top Door Rail (F1) and Bottom Door Rail (G1).

Note: Adjust door rail high up, for easy sliding of door.

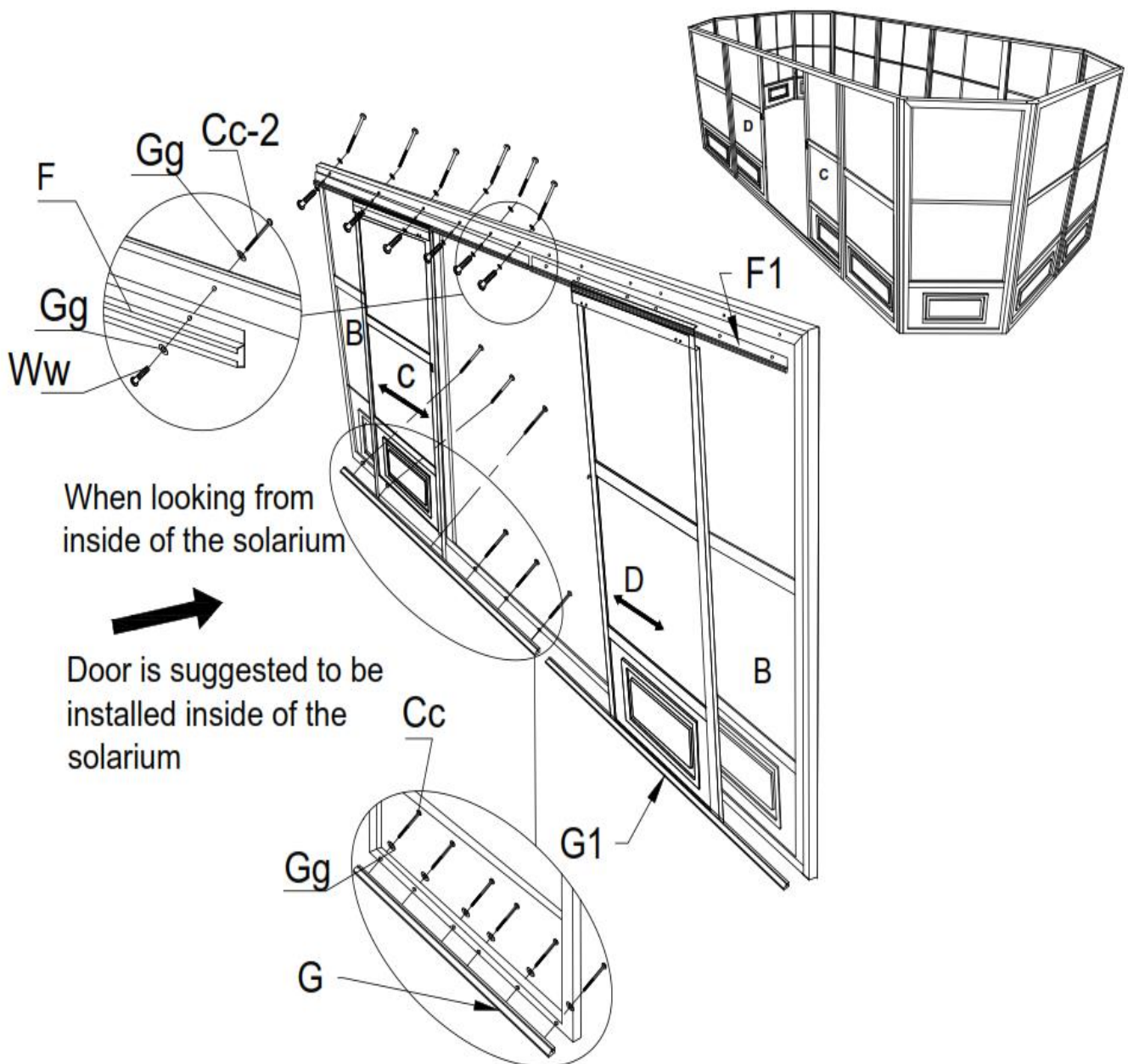

Step 5:

1. Attach roof rafters (L, Xx) to the Central Hub(N) using bolt (Bb).
2. Use screws (Z) to affix the Rafters (L) onto the top of panels going through the Metal Piece (Z2) attached to the Rafter (L).
3. Use Bolts (Bb) to affix Rafter (Xx) over the Horizontal Bar For Door Frame (Zz) at the top of Door opening as shown below.

Note:

1. Rafters must be affixed where panels connect to each other.
2. The Central Hub is a heavy part so it requires support while assembling.

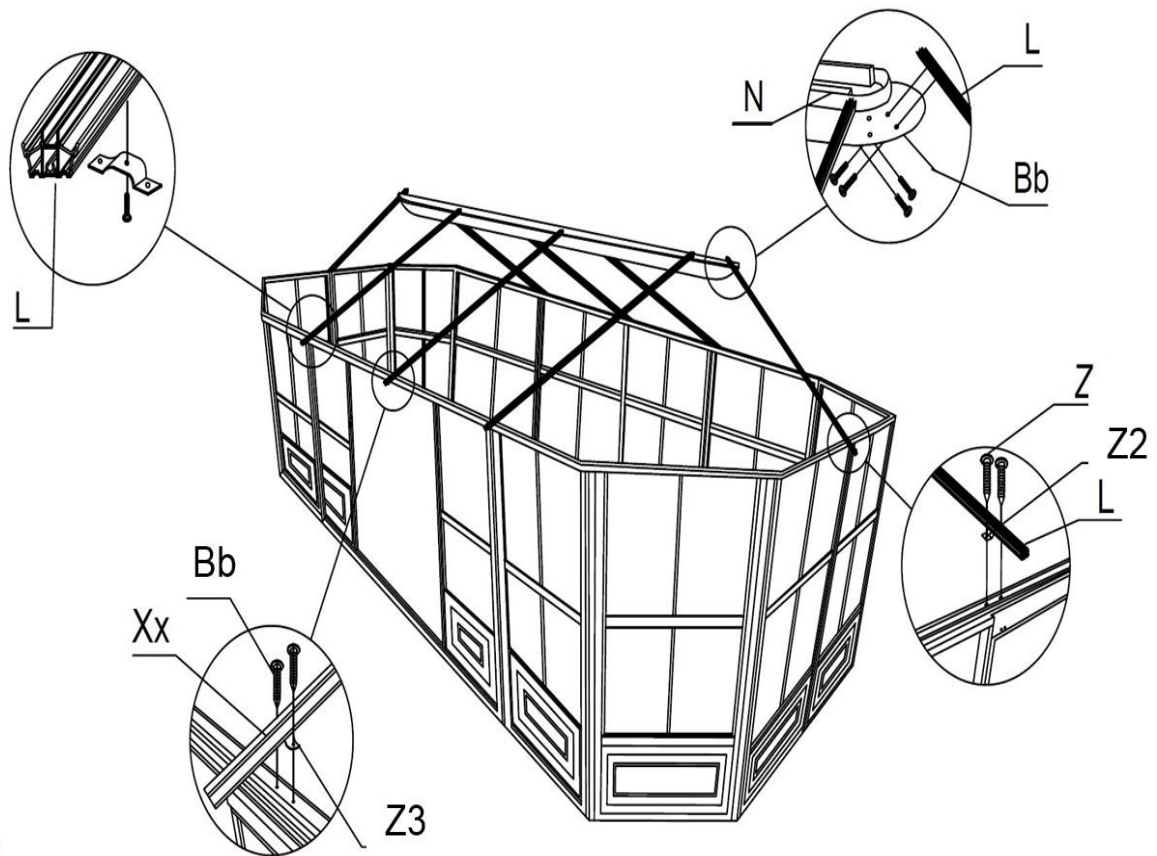

Step 6:

1. Follow the same procedure of Rafter (L) to assemble roof Rafters (K) onto the remaining panels.

Note:

1. Rafters must be affixed where panels connect to each other.
2. Affix the Rafter (K) such that, the extra hole on the bracket (Z1) are facing each other as shown below.
3. Do not tighten the bolts right away as you may have to adjust the angle when inserting the roof panels.

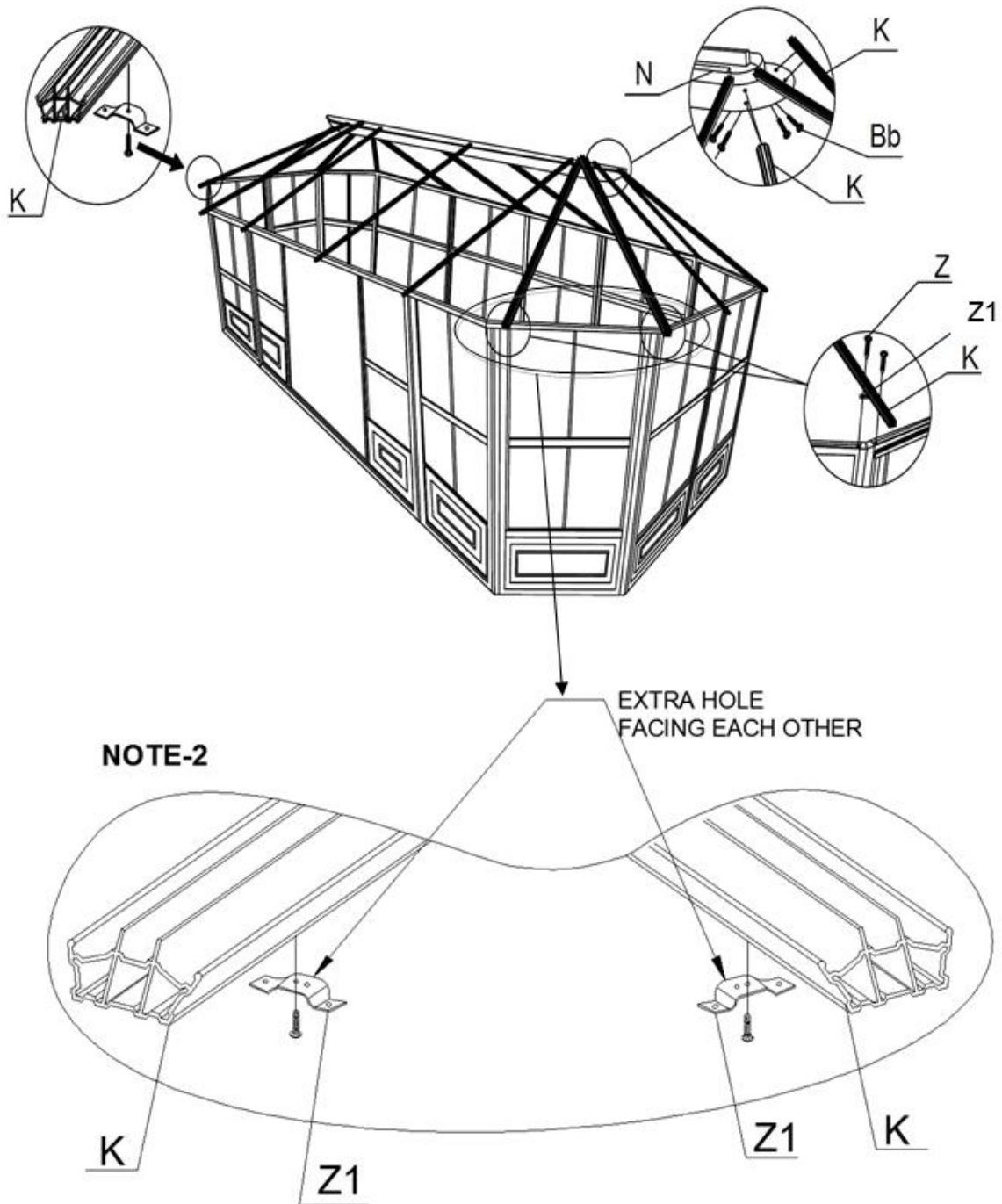

Step 7:

1. Now secure the sides of the roof with Finishing Bar (S, U, Ss and U1) with Bolts (Bb) and Brackets (R).
2. Place roof Finishing Bars (S, U, Ss and U1) on the right of the Roof Finishing Bar (S, U and U1) and align the holes in each bar one on top of the other. Place End Caps (R) under the aligned holes and secure with Bolts (Bb).
3. Repeat process with all Finishing Bars as illustrated.
4. In order to finish the installation of the last Finishing Bar (S, Ss, U, U1) you have to unscrew the first screw (Bb) at your starting point and place an end cap (R) then re-install the screw (Bb).

Note: Make sure all screws/ bolts are tight, when finished assembling.

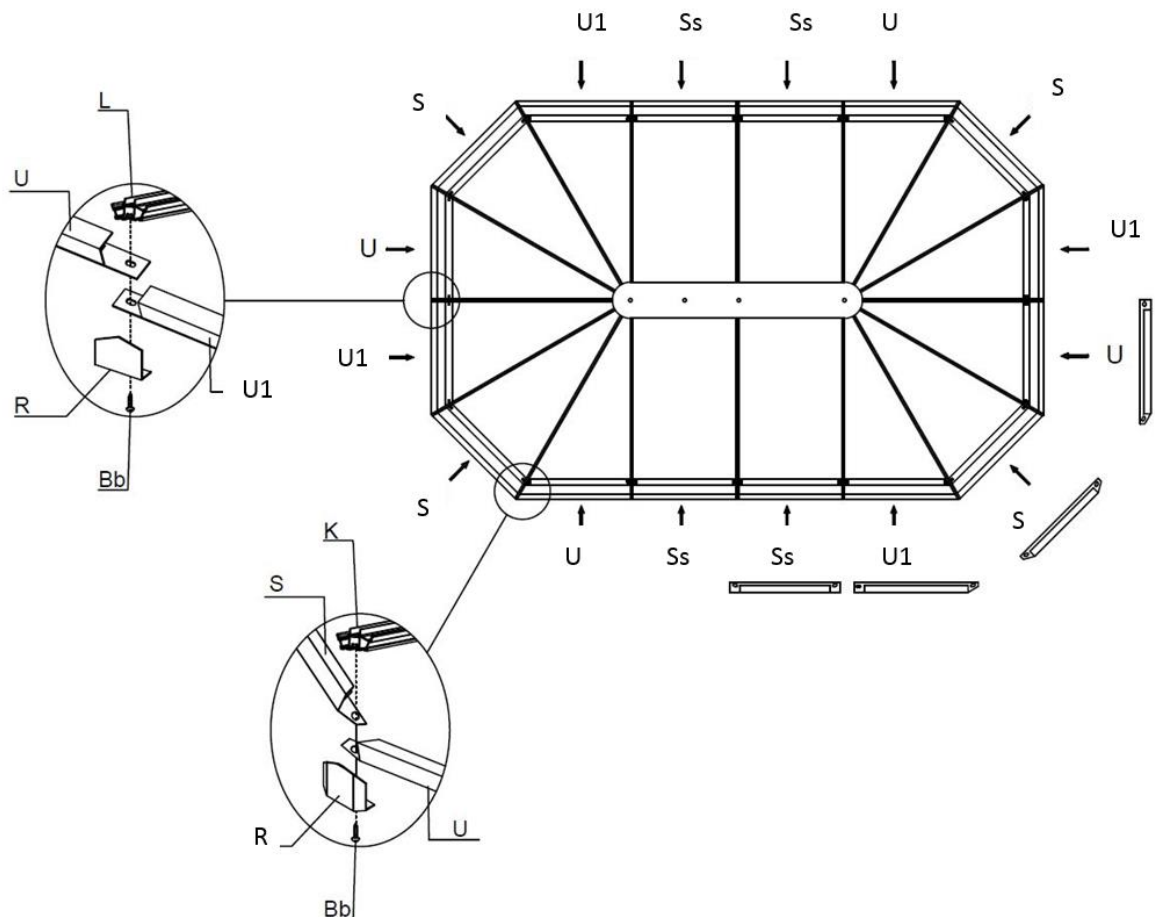

Step 8:

1. From the inside of the solarium, install all the Brackets (Pp) using Bolts (Bb) on the Rafters L & K.
2. From the inside of the solarium, install the Solidifying Bar (T, Tt, V, and V1) as illustrated using the Bolts (Bb).

NOTE :

1. **Make sure all screws/ bolts are tight. But avoid over-tightening as it can damage the threading and head.**

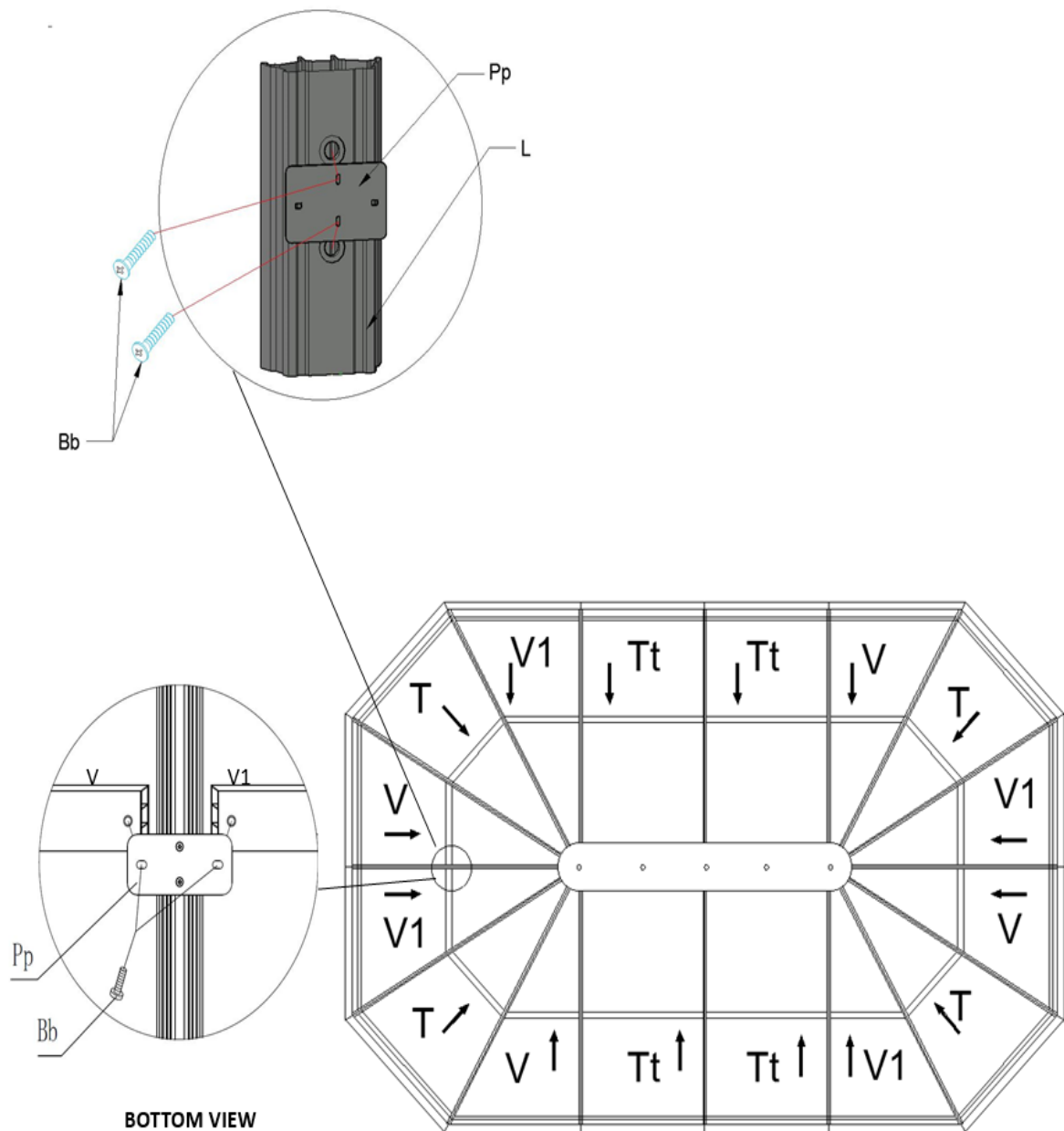

Step 9:

Install the bottom Roof Panels (Jj, Kk, Mm and Rr) by sliding them onto Finishing Bars (S, U, Ss and U1).

NOTE:

1. Please refer to the stickers on how to place the roof panels.
2. Make sure all screws/ bolts are tight.

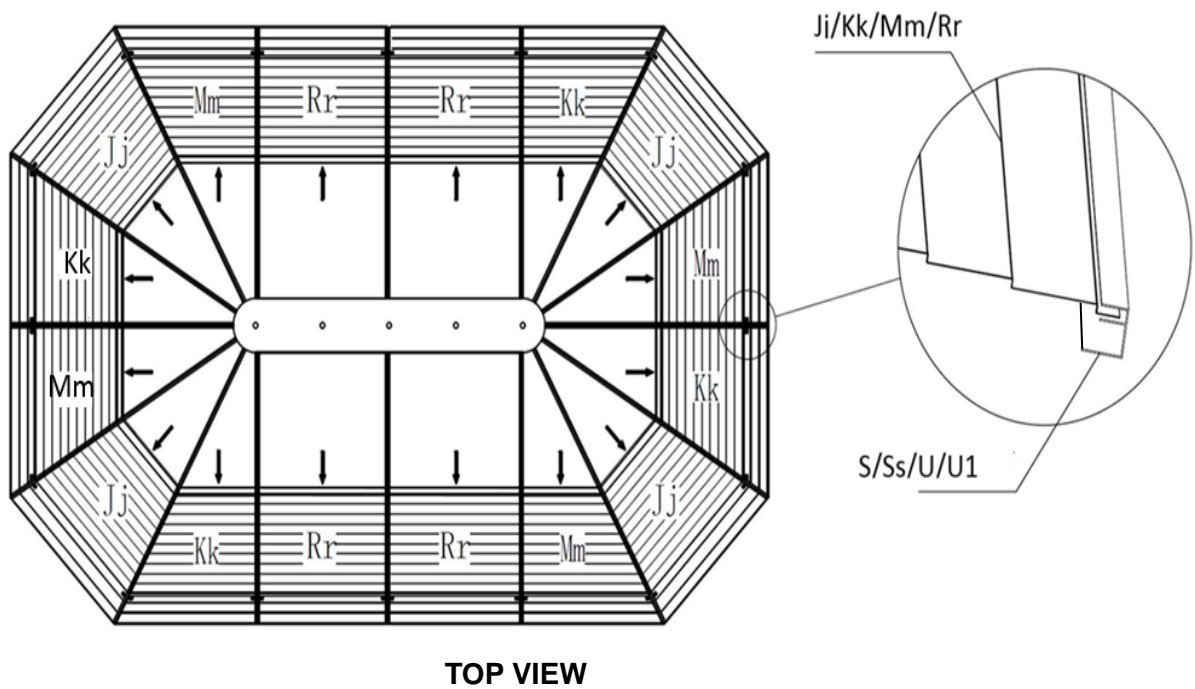

Step 10:

1. Install the upper Roof Panel (Aa) by sliding them on top of roof Rafters (K).

**NOTE: Please refer to the stickers on how to place the roof panels.
Hold panels in position until screwed.**

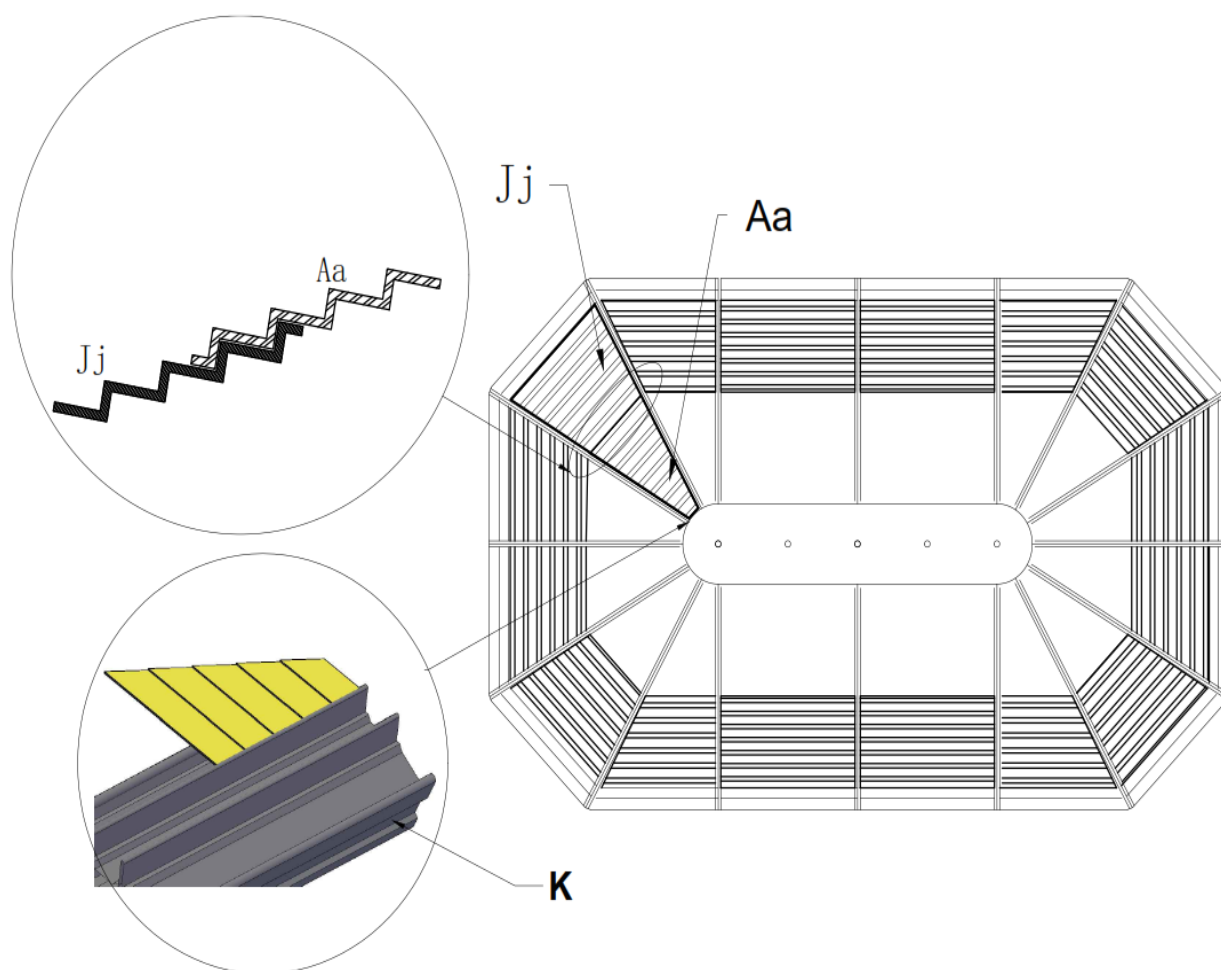

Step 11:

1. Once installation of the Roof Panel (Aa) is complete, affix it using the Cover Roof Bar (O) using the Screws (Oo1) on one side only, then place another roof panel and repeat this step.

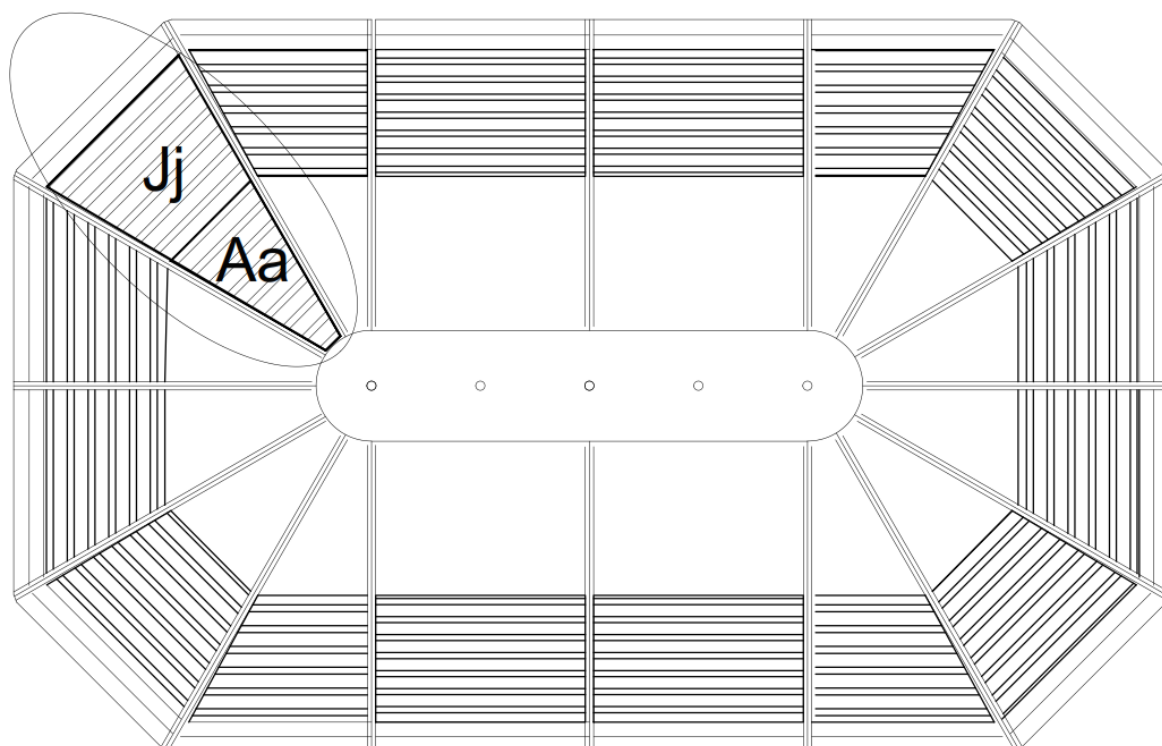
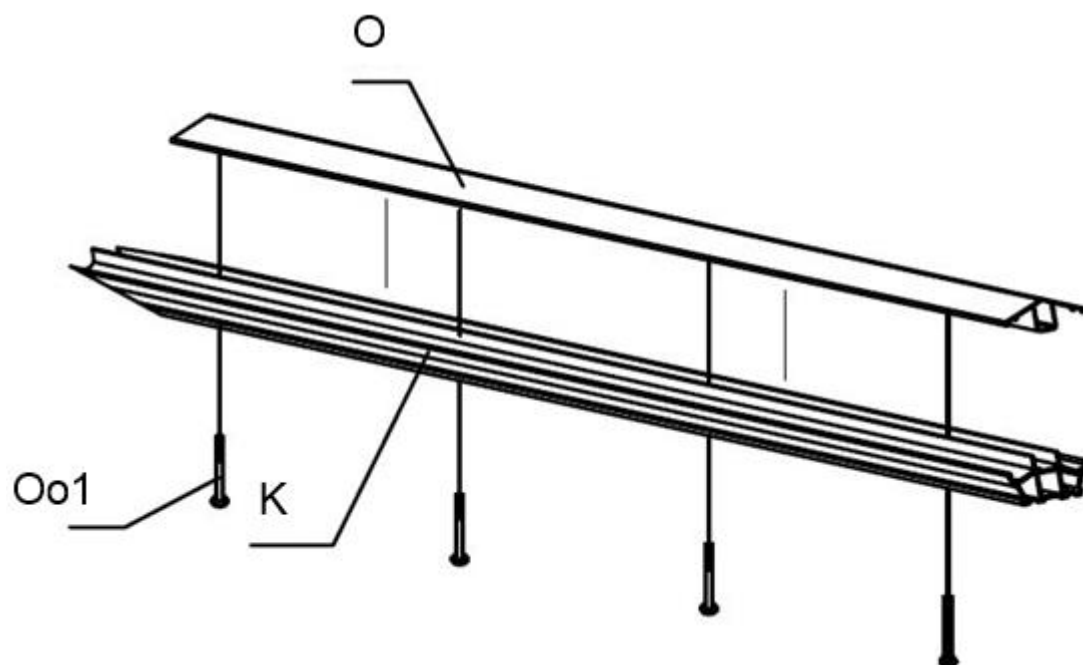

Step 12:

1. Install the Upper Roof Panels (Aa, Ll, Qq, Y) by sliding on top of roof Rafters (K, L) except for one Roof Panel (Qq) while installing Cover Roof Bars (0 & 01).

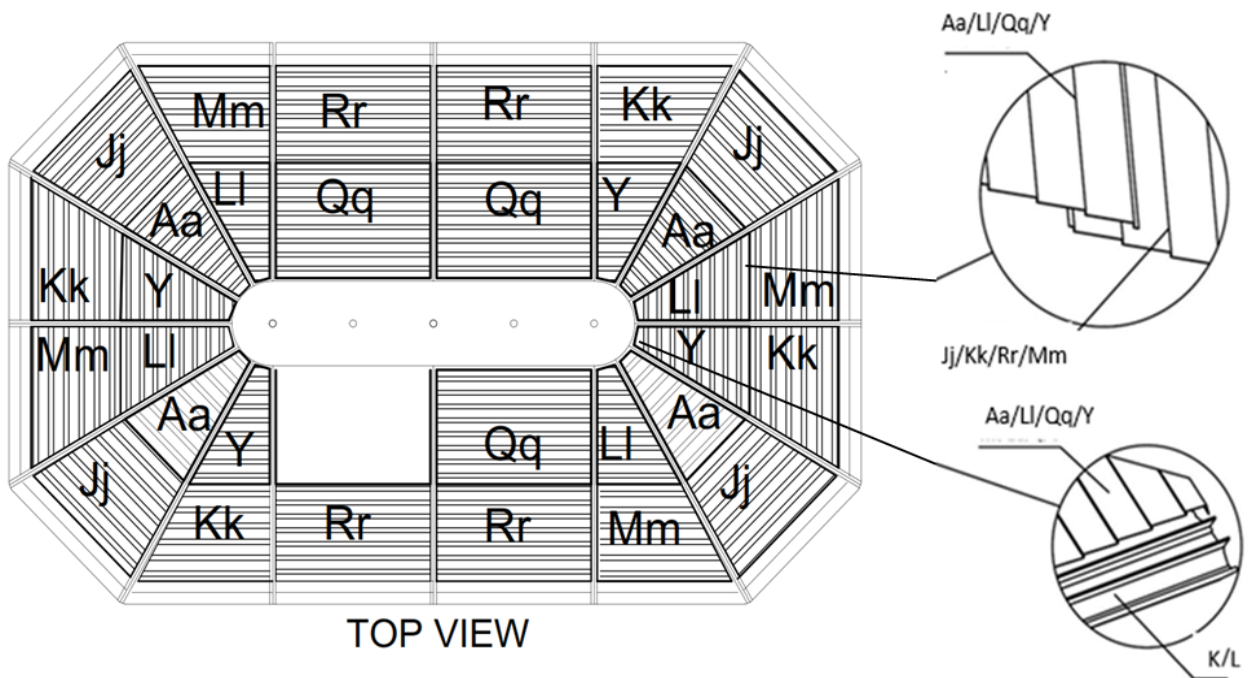
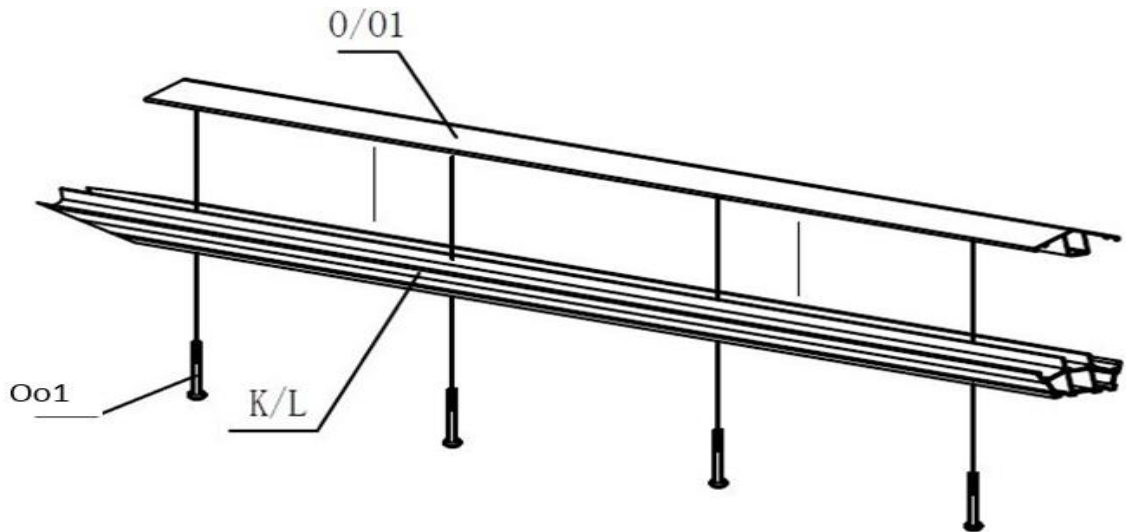

Step 13:

1. Use Nut (Hh) and Washer (Gg) to affix the Top Cap (M) to the Central Hub (N).

NOTE: This is a heavy part and needs to be handled carefully.

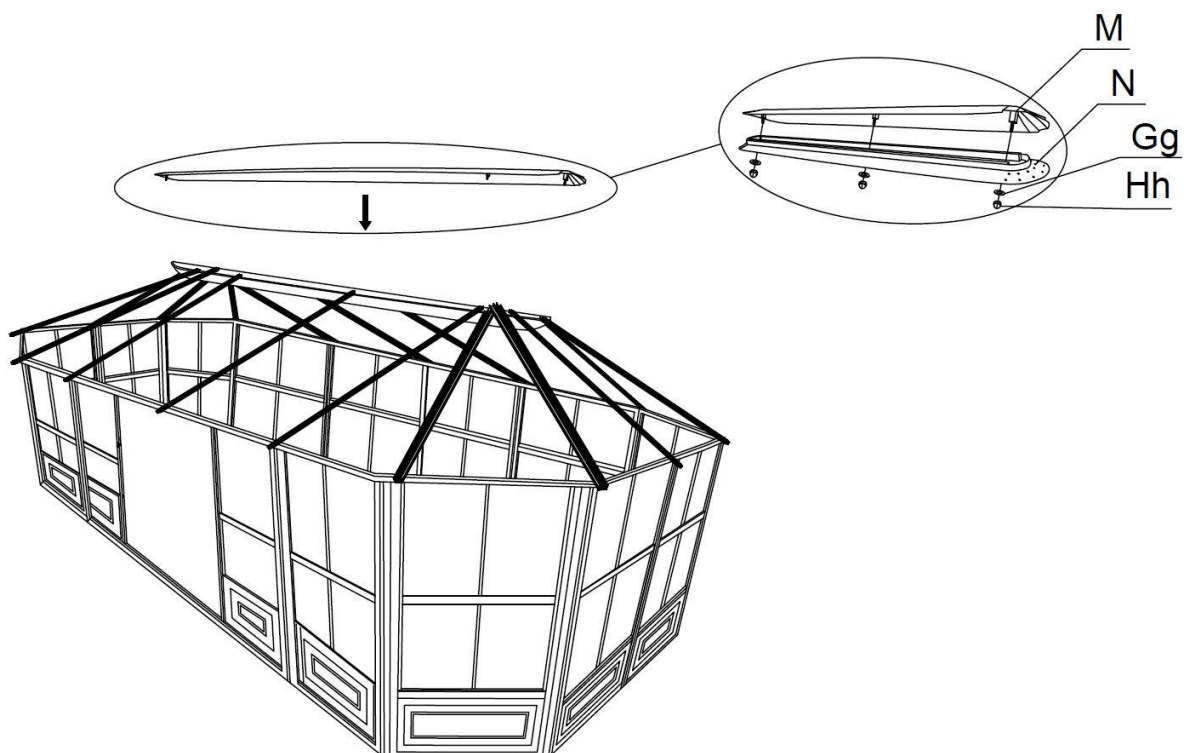

Step 14:

1. Install the last upper Roof Panels (Qq).

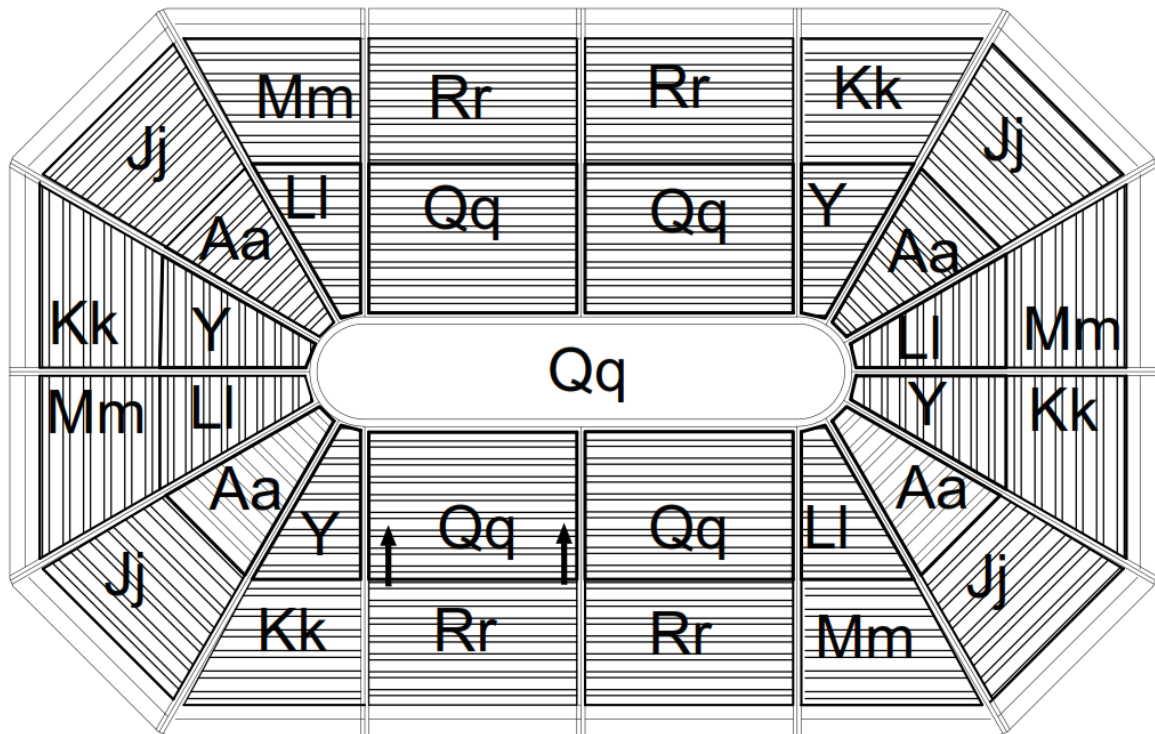

TOP VIEW

Step 15:

1. Once the last roof panel is installed, screw last Cover for Rafter (O1) to the Rafters (L) with bolt (Oo1).

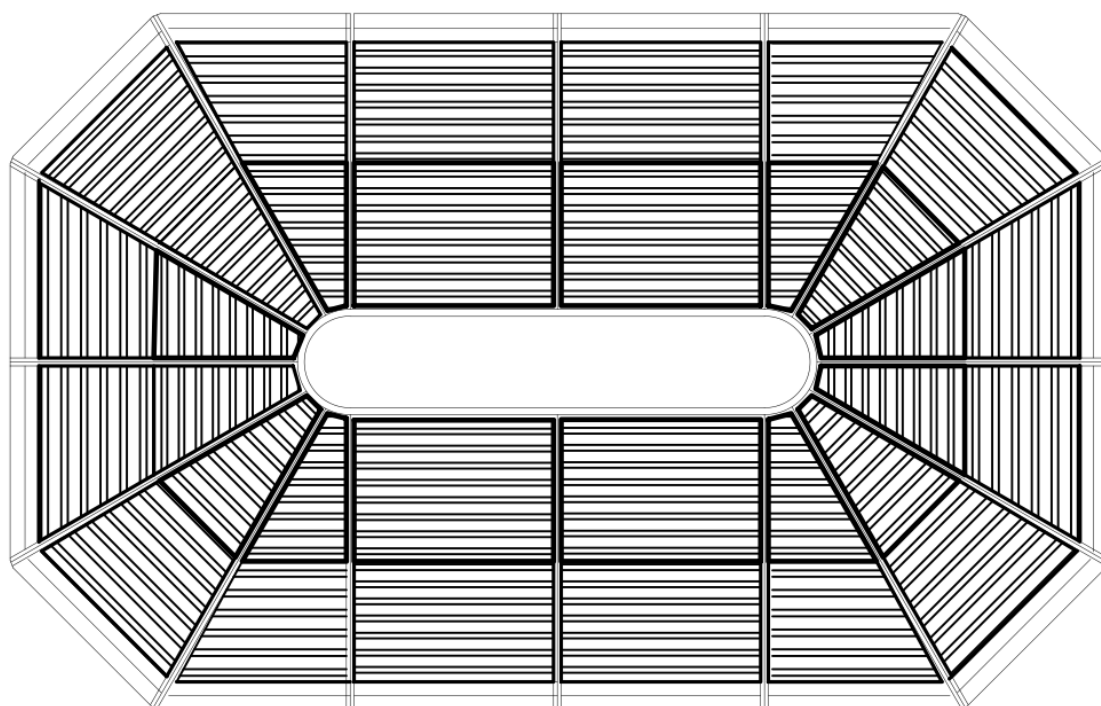
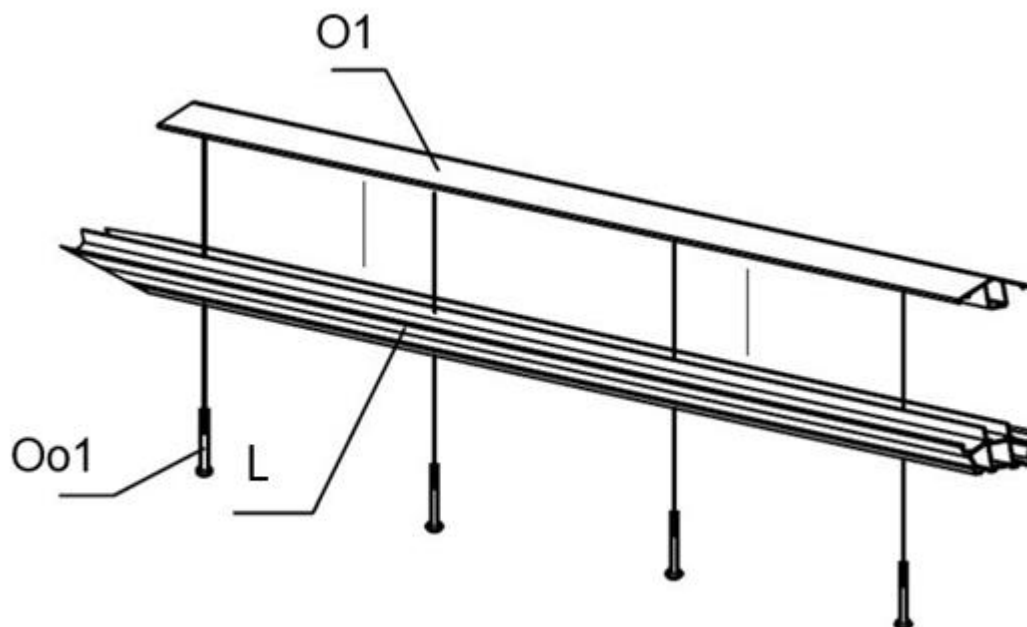

TOP VIEW

Step 16:

1. Inside each of the frames panels, push two Plastic Plugs (Ii) into the ground, and secure the unit by using two Screws (Ee) for each panel or use any other type of anchoring suitable for the floor that you are using.

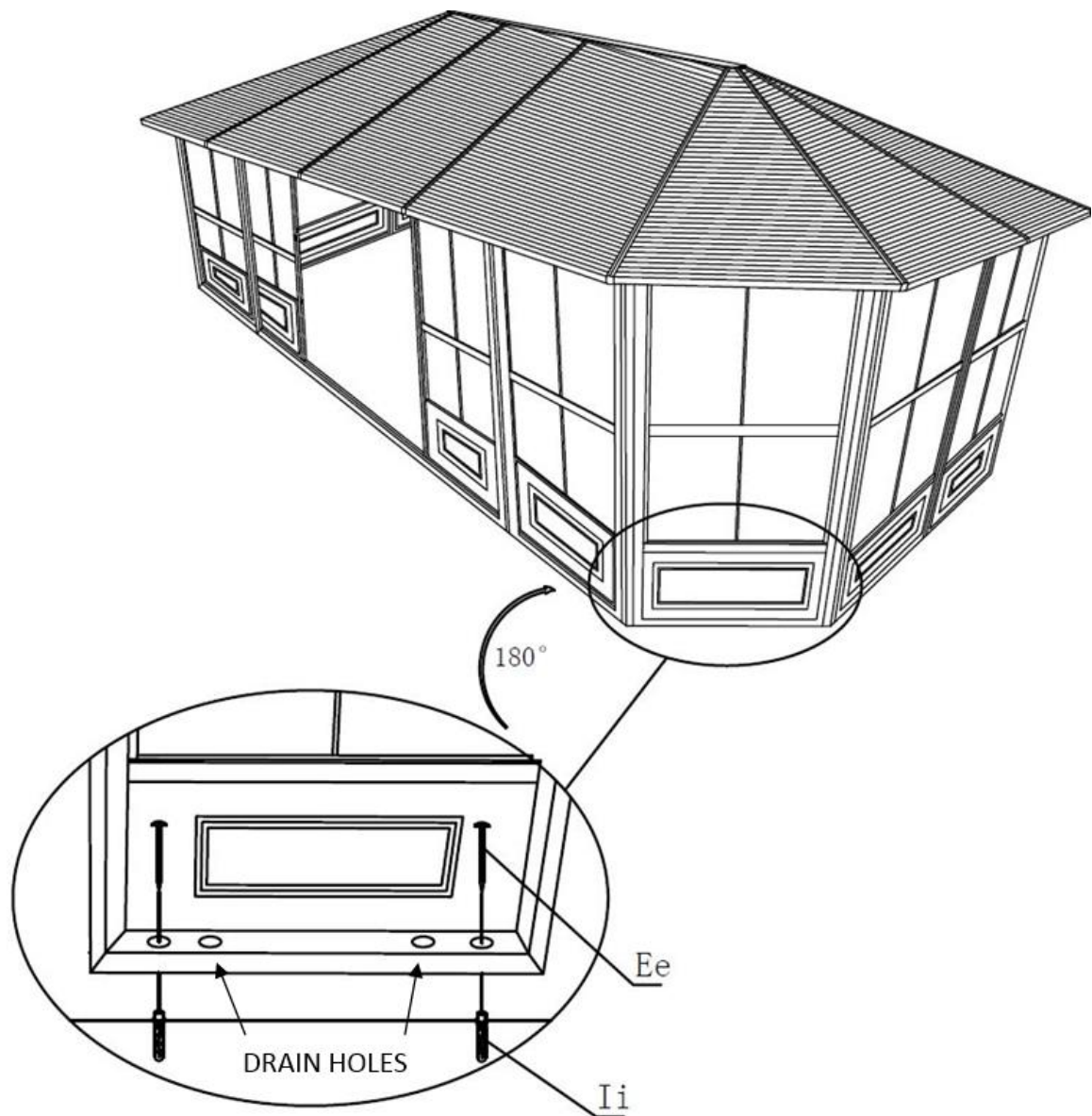

***Suggestions**

The below mentioned are only suggestions in order to permit drainage, these will vary depending on your flooring – material, flatness and slope.

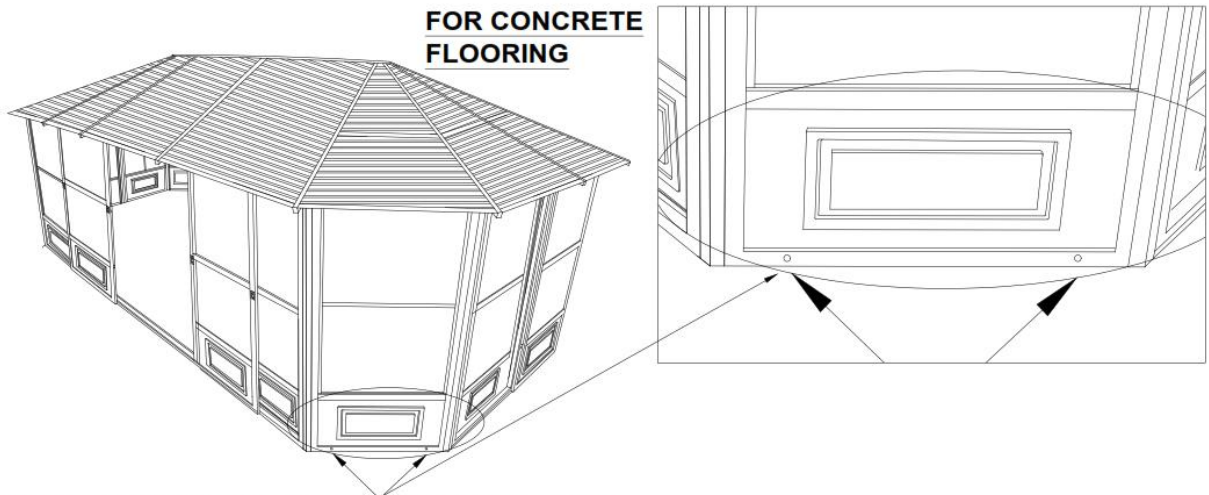

On the outside face, it is suggested to drill holes at the bottom end of the panels to permit drainage when installing on Concrete floor

For Wooden Deck

Drill through the wooden deck where drain holes are located to permit drainage

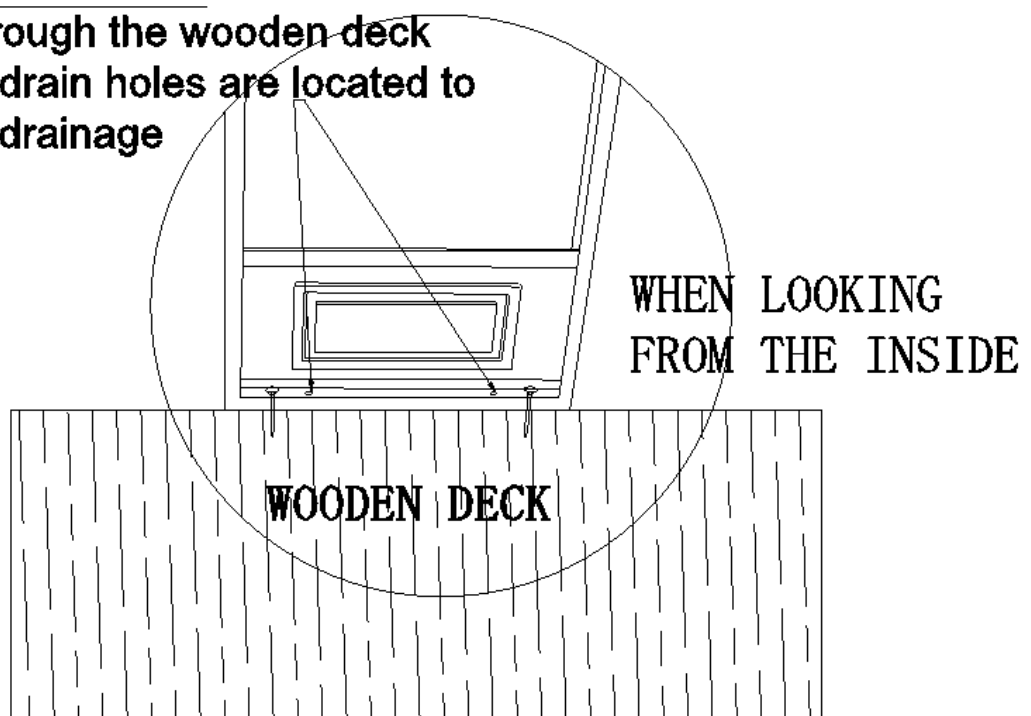

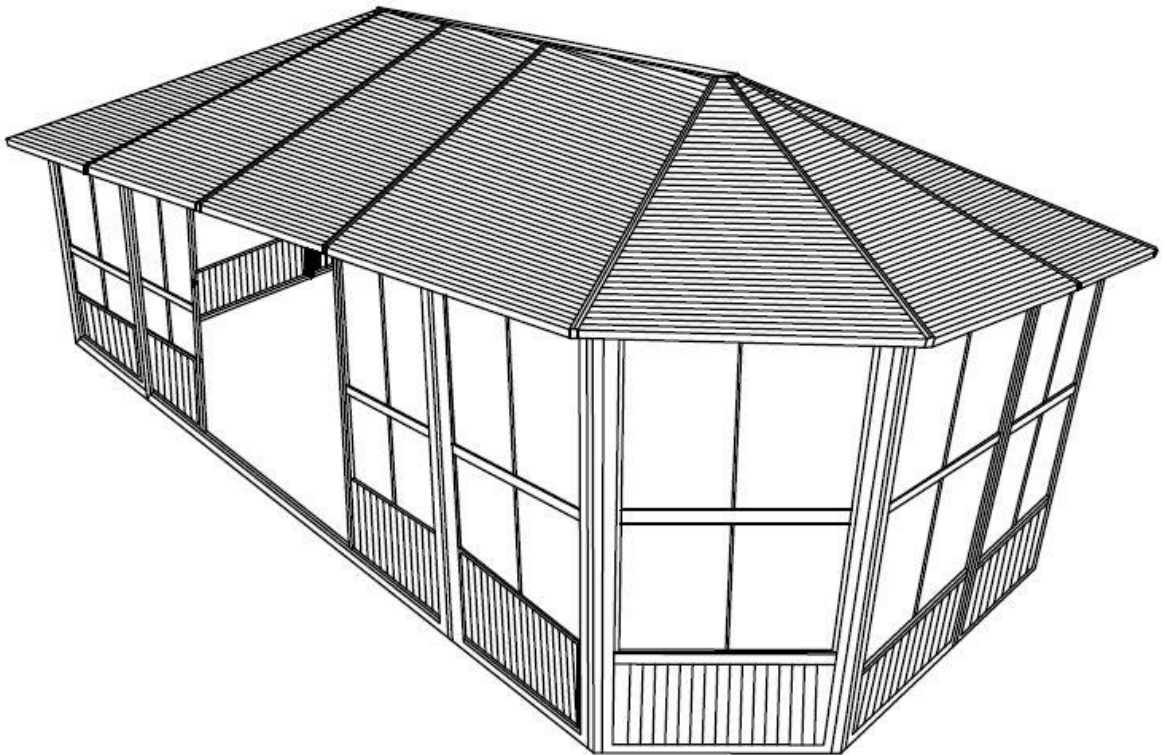
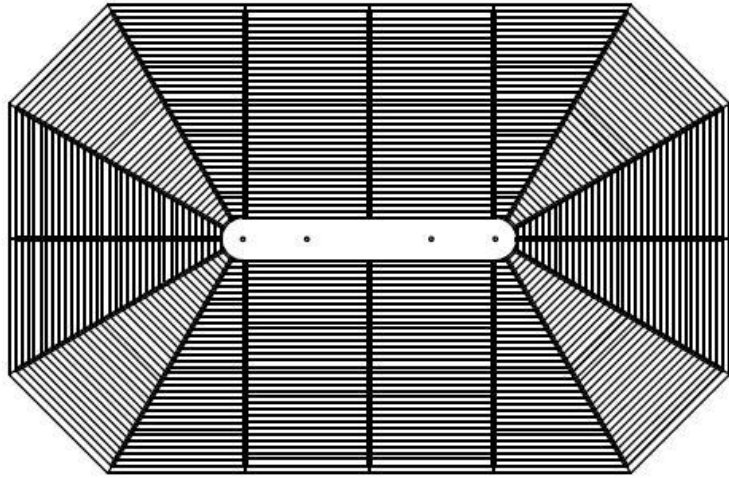

NOTE: The dimensions are approximate.

