

# Kräus<sup>®</sup>

## INSTALLATION MANUAL

### Handmade Stainless Steel Undermount Kitchen Sink

KHU100-26 / KHU100-28 / KHU100-30 / KHU100-32 /  
KHU101-10 / KHU101-13 / KHU101-14 / KHU101-17 /  
KHU101-20 / KHU101-21 / KHU101-22 / KHU101-23 /  
KHU101-24L / KHU102-33 / KHU103-32 / KHU103-33 /  
KHU104-33 / KHU105-32 / KHU110-27 / KHU111-24 /  
KHU111-25 / KHU121-23 / KHU122-23 / KHU123-32

## **Congratulations on the purchase of your new Kraus plumbing fixture!**

Please keep the box and packaging materials until your product is completely installed. If you have any questions, require technical assistance or have any problems with your product:

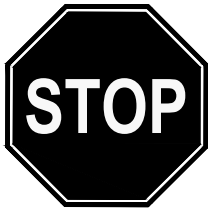

**DO NOT RETURN TO STORE**

**Please contact our Customer Service Team  
1-800-775-0703 / [customerservice@kraususa.com](mailto:customerservice@kraususa.com)**

Have the model number available and retain a copy of your receipt with purchase date for reference.

If for any reason this product does not meet your expectations, please be sure to repack this product in the original box and packaging material to avoid damage during transit.

Prior to Installation:

- Make sure that you have all necessary parts by checking the parts list. If any part is missing or damaged, please contact Kraus Customer Service at 800-775-0703 for a replacement
- Inspect the sink prior to installation to make sure that it has not been damaged or during shipping
- Use the cut-out template provided by Kraus
- Observe all plumbing and building codes according to your state requirements
- Not recommended to be installed with laminate countertop

**For technical assistance or replacement parts, please contact Kraus Customer Service and one of our representatives will be happy to help:**

**Toll-Free: 800-775-0703 or [customerservice@kraususa.com](mailto:customerservice@kraususa.com)**

The step-by-step guidelines in the installation instructions are a general reference for installing a Kraus sink. Should there be any discrepancies, Kraus cannot be held liable. It is recommended to install all Kraus products by hiring a licensed professional.

## Tools you will need:

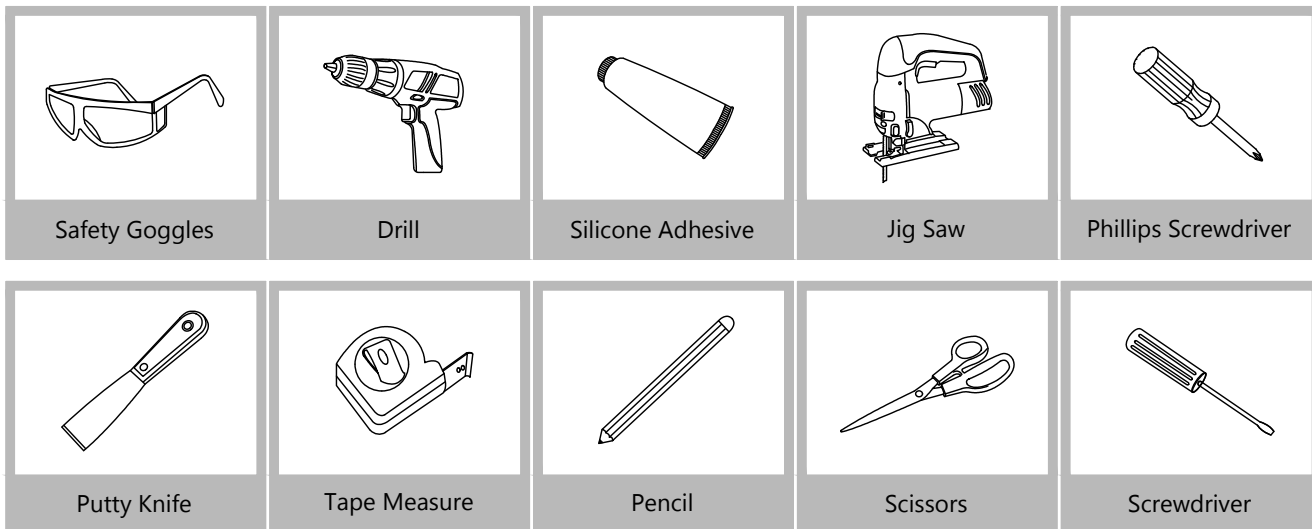

**NOTE:** Specialized tools may be necessary to install Kraus Stainless Steel Kitchen sinks with countertop materials other than wood, marble or granite.

## Dimensions:

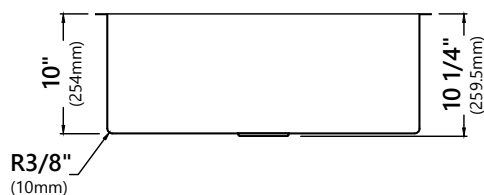
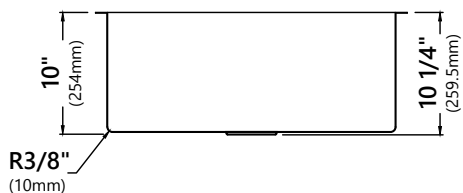
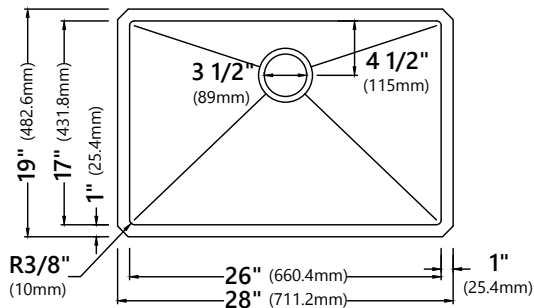
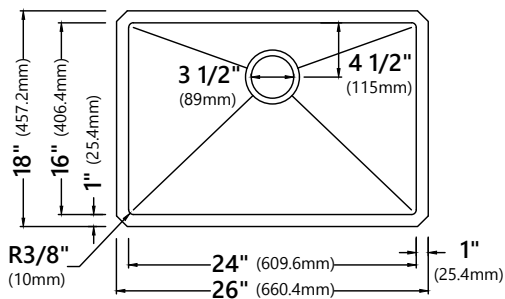

KHU100-26  
 26" x 18" x 10"  
 Min Cabinet Size: 30"  
 Matching Grid: KBG-100-26  
 Drain Model #: ST-1

KHU100-28  
 28" x 19" x 10"  
 Min Cabinet Size: 33"  
 Matching Grid: KBG-100-28  
 Drain Model #: ST-1

## Dimensions:

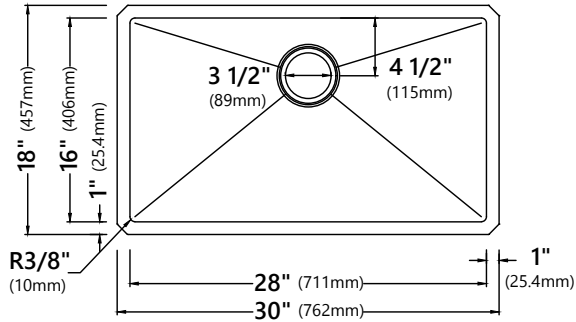

**KHU100-30**  
 30" x 18" x 10"  
 Min Cabinet Size: 33"  
 Matching Grid: KBG-100-30  
 Drain Model #: BST-1

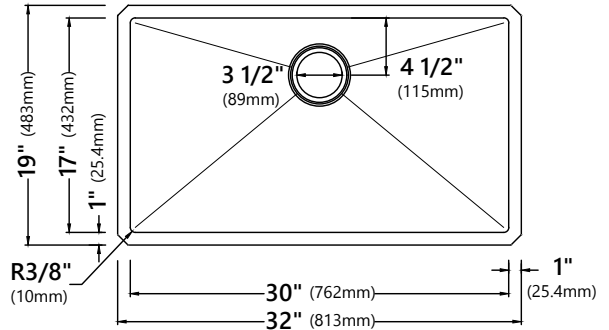

**KHU100-32**  
 32" x 17" x 10"  
 Min Cabinet Size: 36"  
 Matching Grid: KBG-100-32  
 Drain Model #: BST-1

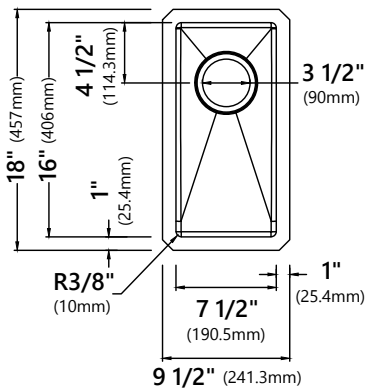

**KHU101-10**  
 9 1/2" x 18" x 8"  
 Min Cabinet Size: 12"  
 Drain Cap #: STC-2  
 Drain Model #: ST-1

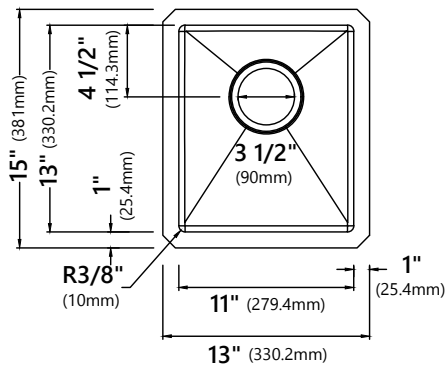

**KHU101-13**  
 13" x 15" x 8"  
 Min Cabinet Size: 15"  
 Drain Cap #: STC-2  
 Drain Model #: ST-1

# Dimensions:

Typical note: \* = Special Order

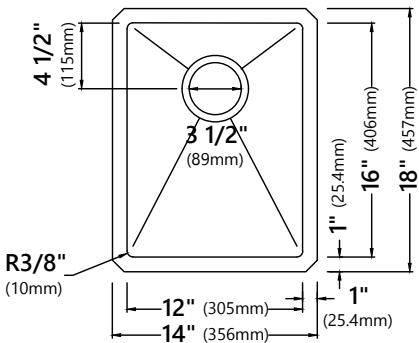

**KHU101-14**  
 14" x 18" x 8"  
 Min Cabinet Size: 18"  
 Drain Model #: ST-1

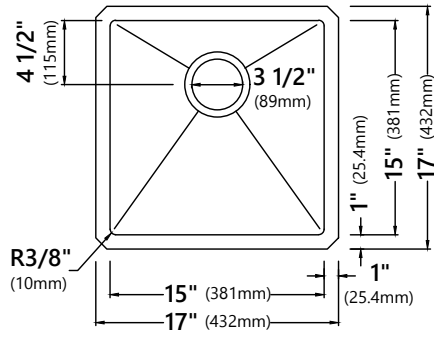

**KHU101-17**  
 17" x 17" x 10"  
 Min Cabinet Size: 21"  
 Drain Model #: ST-1

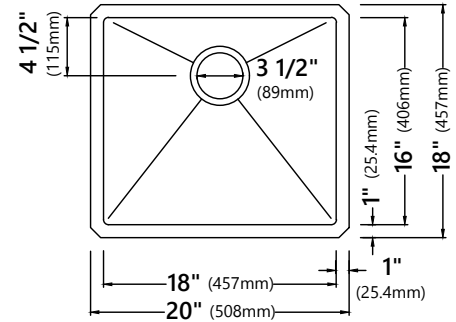

**\* KHU101-20**  
 20" x 18" x 10"  
 Min Cabinet Size: 24"  
 Matching Grid: KBG-101-20  
 Drain Model #: ST-1

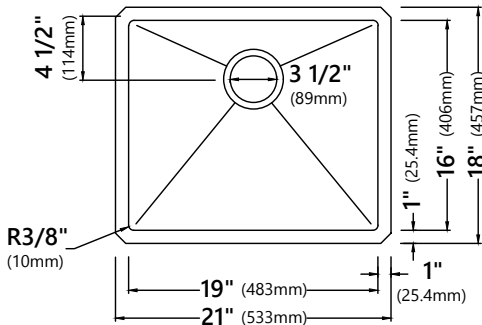

**KHU101-21**  
 21" x 18" x 10"  
 Min Cabinet Size: 24"  
 Matching Grid: KBG-101-21  
 Drain Model #: ST-1

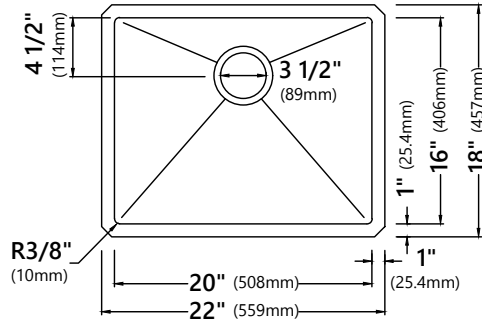

**\* KHU101-22**  
 22" x 18" x 10"  
 Min Cabinet Size: 27"  
 Matching Grid: KBG-101-22  
 Drain Model #: ST-1

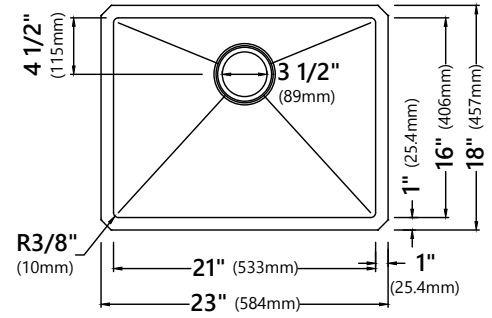

**KHU101-23**  
 23" x 18" x 10"  
 Min Cabinet Size: 27"  
 Matching Grid: KBG-101-23  
 Drain Model #: BST-1

## Dimensions:

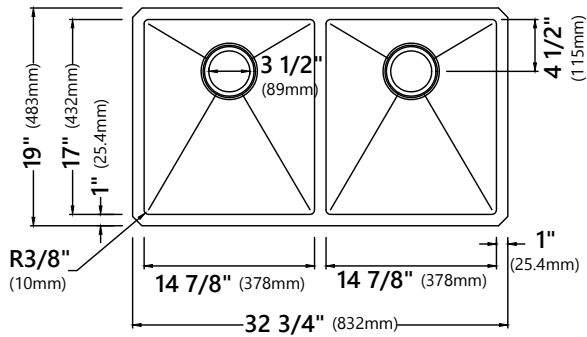

**KHU102-33**  
 32 3/4" x 19" x 10"  
 Min Cabinet Size: 36"  
 Matching Grid: KBG-102-33-1  
 and KBG-102-33-2  
 Drain Model #: BST-1 & ST-1

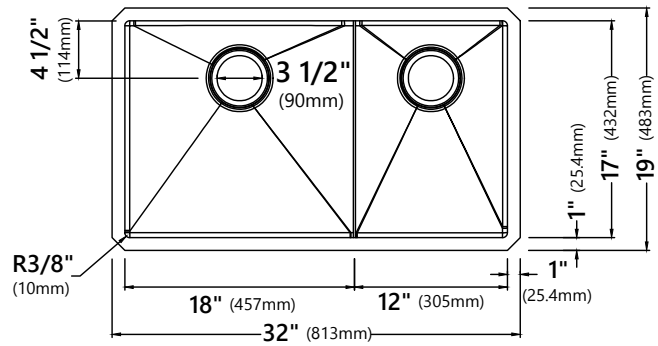

**KHU103-32**  
 32" x 19" x 10"  
 Min Cabinet Size: 36"  
 Matching Grid: KBG-103-32-1  
 and KBG-103-32-2  
 Drain Model #: ST-1 x 2  
 Drain Cap #: STC-2 x 2

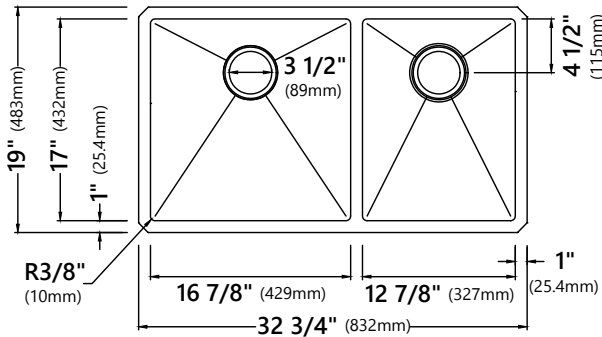

**KHU103-33**  
 32 3/4" x 19" x 10"  
 Min Cabinet Size: 36"  
 Matching Grid: KBG-103-33-1  
 and KBG-103-33-2  
 Drain Model #: BST-1 & ST-1

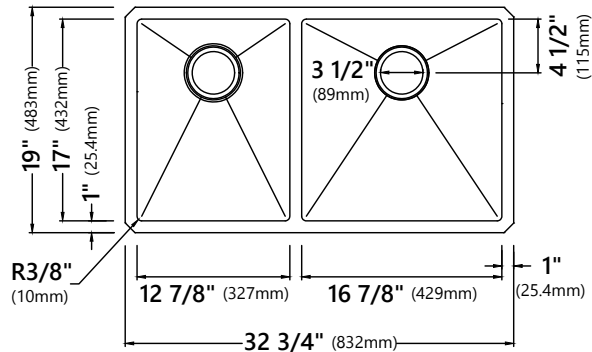

**KHU104-33**  
 32 3/4" x 19" x 10"  
 Min Cabinet Size: 36"  
 Matching Grid: KBG-104-33-1  
 and KBG-104-33-2  
 Drain Model #: BST-1 & ST-1

## Dimensions:

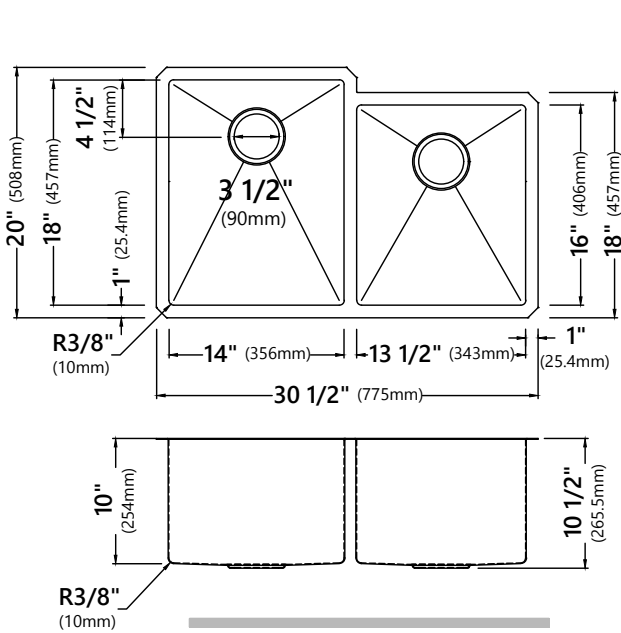

**KHU105-32**  
 30 1/2" x 20" x 10"  
 Min Cabinet Size: 36"  
 Matching Grid: KBG-105-32-1 and  
 KBG-105-32-2  
 Drain Model #: BST-1 & ST-1

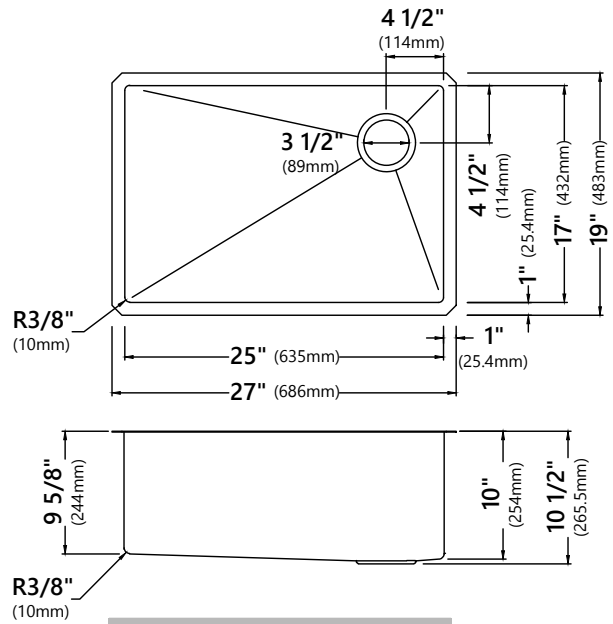

**KHU110-27**  
 27" x 19" x 10"  
 Min Cabinet Size: 30"  
 Matching Grid: KBG-110-27  
 Drain Model #: ST-1  
 Drain Cap #: STC-2

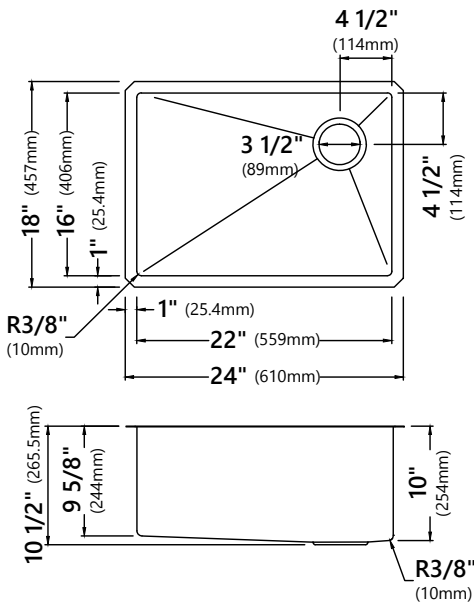

**KHU111-24**  
 24" x 18" x 10"  
 Min Cabinet Size: 27"  
 Matching Grid: KBG-111-24  
 Drain Model #: ST-1

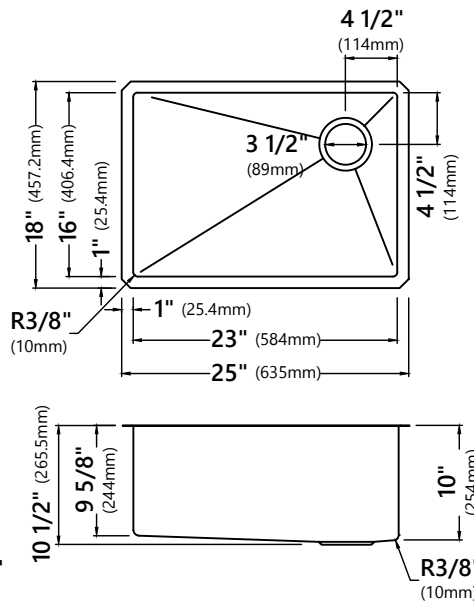

**KHU111-25**  
 25" x 18" x 10"  
 Min Cabinet Size: 30"  
 Matching Grid: KBG-111-25  
 Drain Model #: ST-1  
 Drain Cap #: STC-2

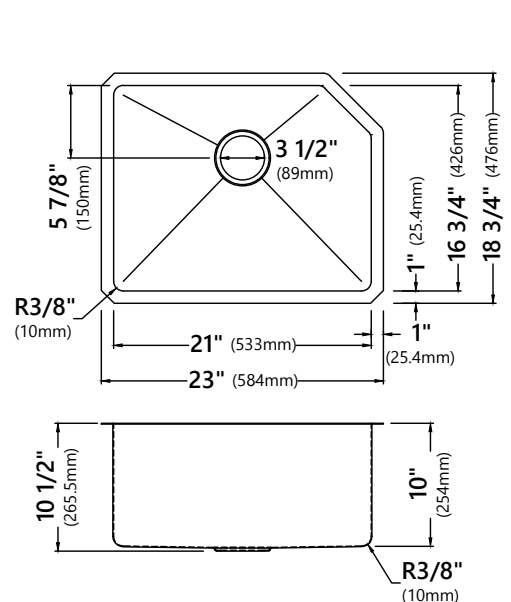

**KHU121-23**  
 23" x 18 3/4" x 10"  
 Min Cabinet Size: 27"  
 Matching Grid: KBG-121-23  
 Drain Model #: BST-1



## Dimensions:

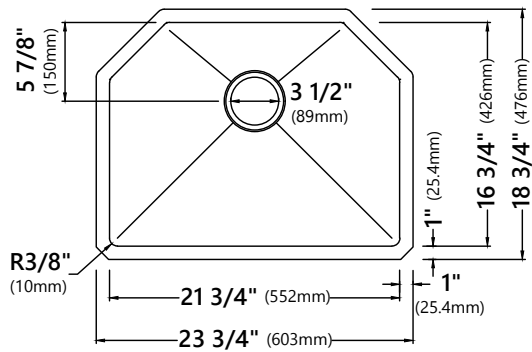

**KHU122-23**  
 23 3/4" x 18 3/4" x 10"  
 Min Cabinet Size: 27"  
 Matching Grid: KBG-122-23  
 Drain Model #: BST-1

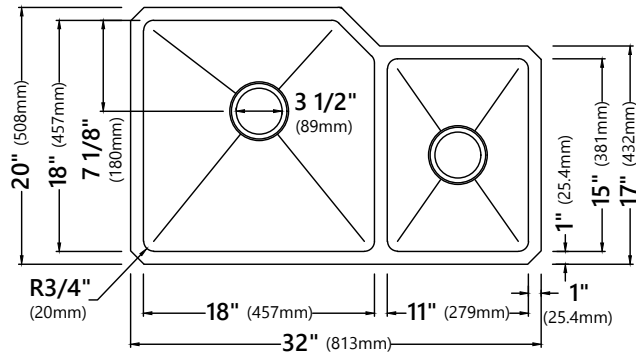

**KHU123-32**  
 32" x 20" x 10"  
 Min Cabinet Size: 36"  
 Matching Grid: KBG-123-32-1  
 and KBG-123-32-2  
 Drain Model #: BST-1 & ST-1

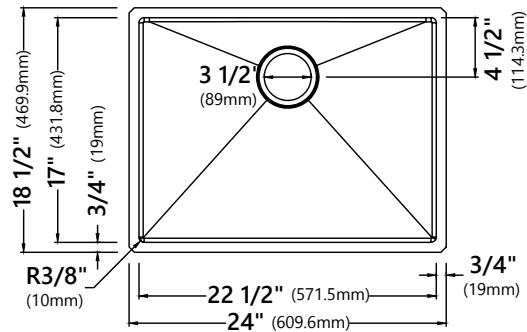
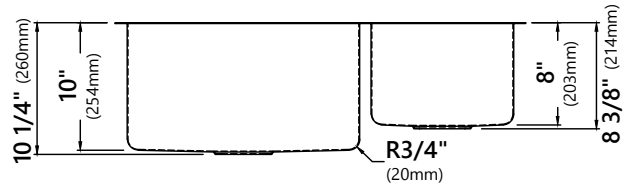
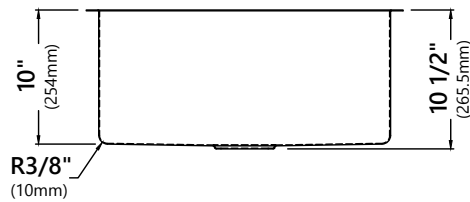

**KHU101-24L**  
 24" x 18 1/2" x 12"  
 Min Cabinet Size: 27"  
 Matching Grid: KBG-101-24  
 Drain Model #: ST-1  
 Drain Cap #: STC-2

# Undermount Installation

## Step 1. Determine reveal type

- Use scissors to cut along the line of the paper template for your desired reveal type (Negative, Positive, or Flush Reveal)

### KRAUS Recommended Installation Type

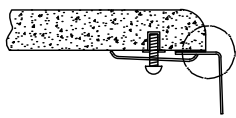

3/8" Positive Reveal

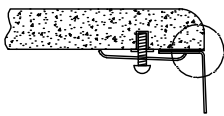

Flush/Zero Reveal

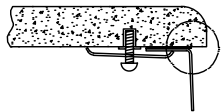

1/8" Negative Reveal

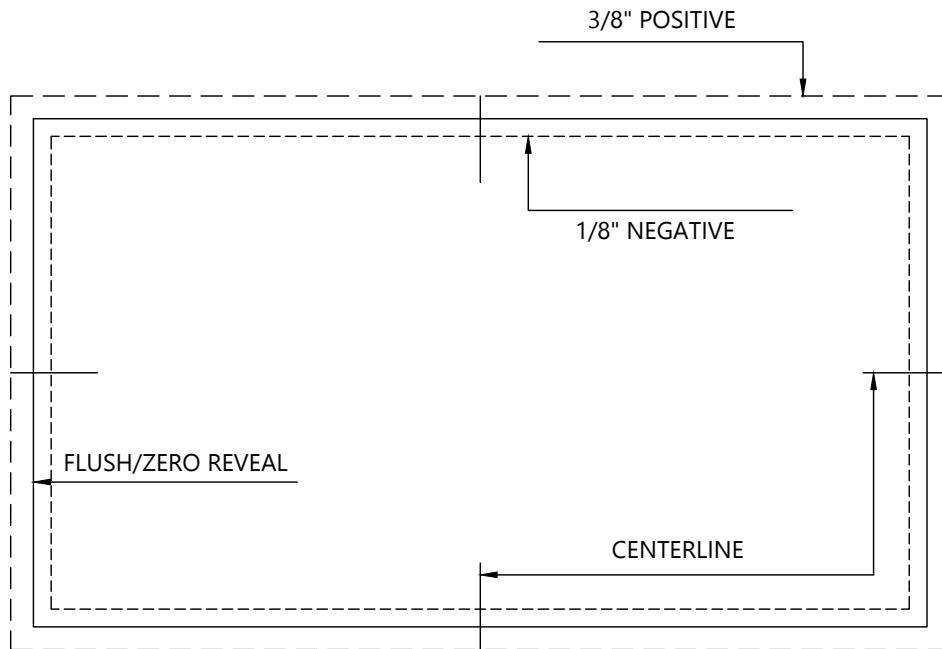

## Step 2. Position template

---

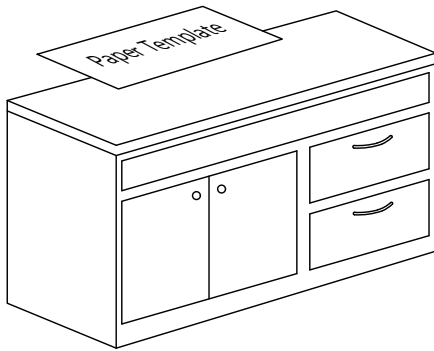

- Check the cut-out template against the actual sink to ensure a proper sized cut-out.
- Place the cut-out template in the desired location on the countertop.

**NOTE:** Make sure clearance is suitable for backsplash, faucet and plumbing for the sink.

## Step 3. Trace Template

---

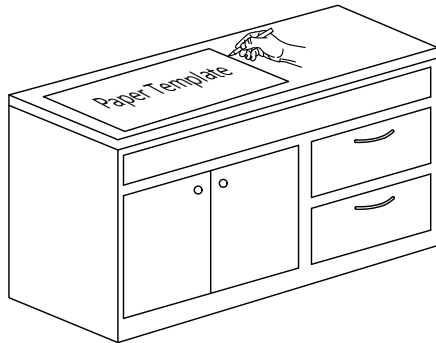

- Trace template on countertop with a pencil.

## Step 4. Cut countertop

---

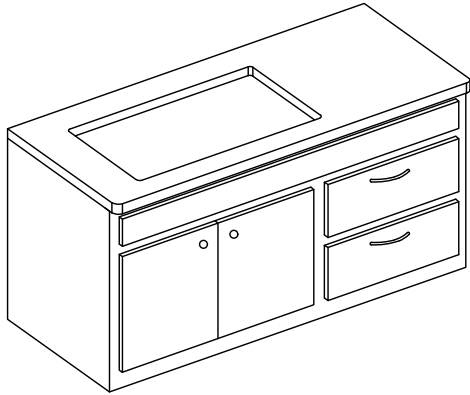

- Cut the opening in the countertop by carefully following the traced line.

**NOTE:** Please use the appropriate saw that best fits your countertop material.

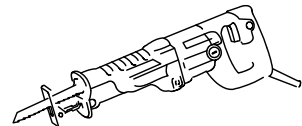
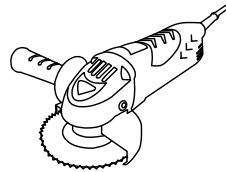
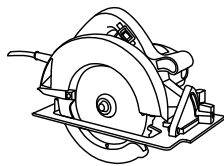
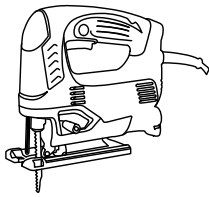

## Step 5. Set up mounting brackets

---

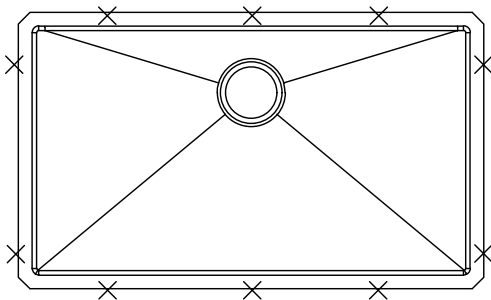

- Turn countertop over and align sink with countertop. Decide location for mounting brackets.
- Mounting holes should be 1/2" from edge of sink.

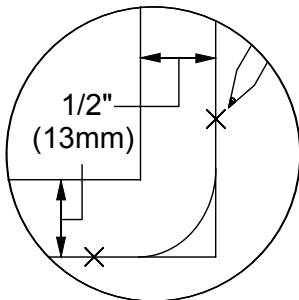

## Step 6. Drill hole in countertop

---

- Drill 3/8" diameter x 1/2" deep hole in the countertop.

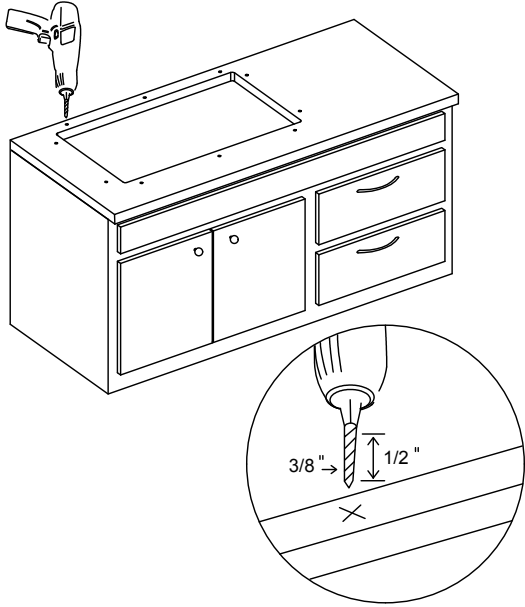

## Step 7. Install anchors

---

- Insert anchors into drilled holes and lightly tap with a hammer until flush.

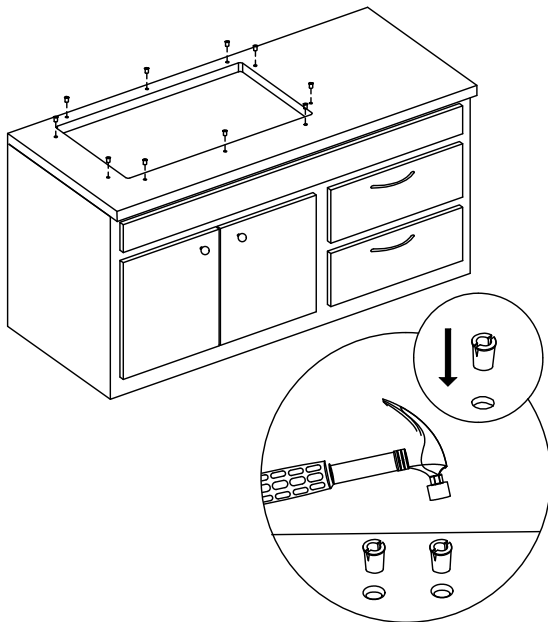

## Step 8. Secure sink to countertop

---

- Use a bead of silicone (or preferred adhesive) around the rim of the sink. Check the alignment of the sink to the cutout in the countertop. Place sink over cutout hole and press firmly.

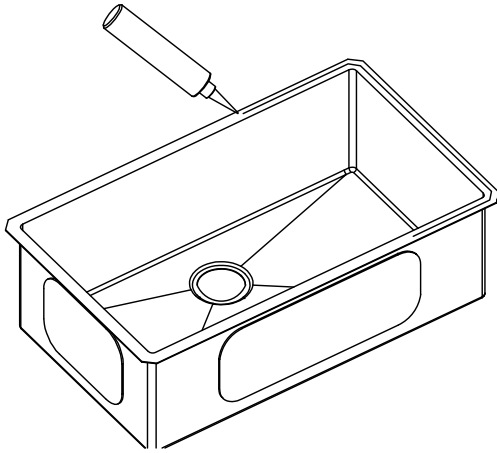

## Step 9. Attach mounting hardware

---

- Attach mounting hardware to secure bowl. Remove excess sealant from inside lip.
- Allow sealant to set for 30 - 60 minutes.

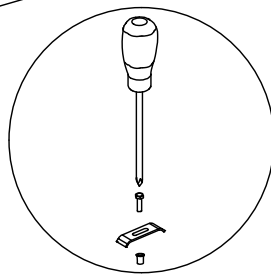
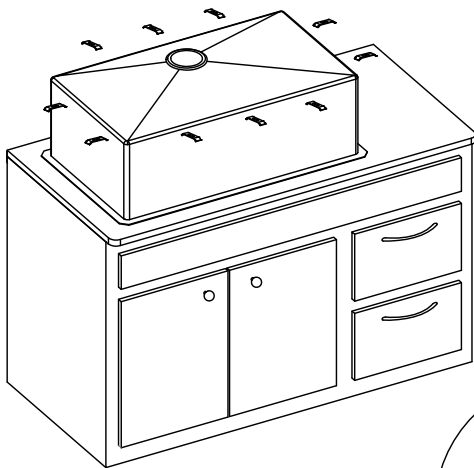

**NOTE:** Use acetone or rubbing alcohol to remove any excess sealant.

## Step 10. Install plumbing fixtures

---

- Connect drain to sink. Connect trap to drain. Connect water supply connections to faucet according to manufacturer's instructions.
- Run water into sink and check for leaks.

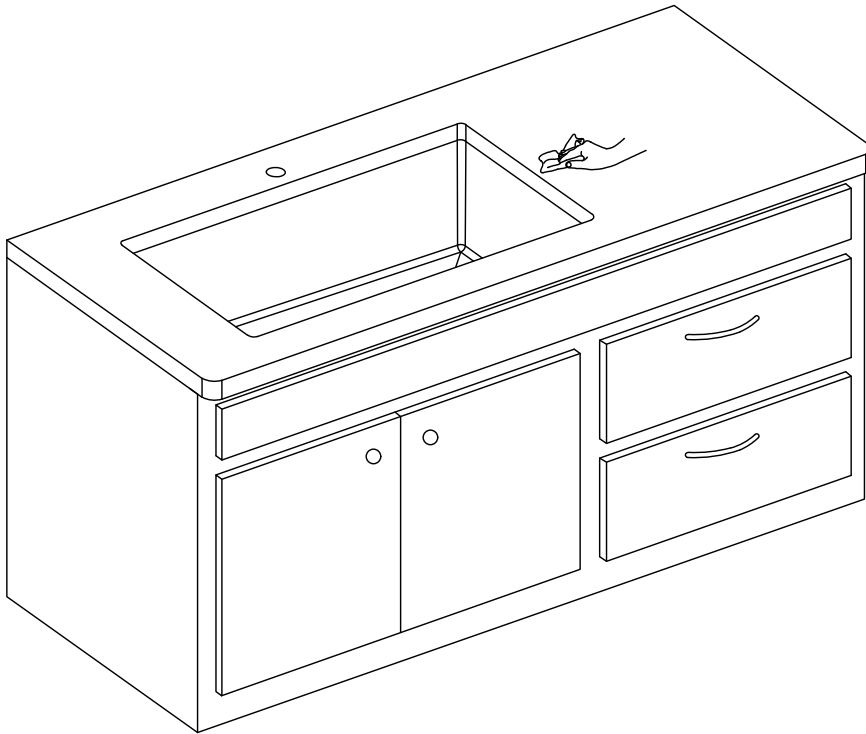

## Maintenance

---

Clean your sink on a regular basis with warm soapy water. Rinse the sink after using cleaning products. Wipe the sink surface with a soft cloth to remove any liquid residue. Do not cut food directly on the surface of the sink. Do not leave sharp objects on the surface of the sink for an extended period of time. Do not use abrasive cleaning products, sanding tools, steel wool or bleaching products.

## Codes/Standards Applicable



### Kitchen Sink Warranty

Kraus products are manufactured and tested to the highest quality standards by Kraus USA Inc. ("Kraus").

Kraus extends this warranty to the original purchaser for personal household use of the "Kitchen Sink" in its original location. The warranty is non-transferable.

Kraus warrants the structure and finish of the product to be free from defects in material and workmanship under normal usage for the lifetime of the product. The warranty commences from the initial date of purchase by the owner or trade professional, from an authorized Kraus dealer, through the lifetime of the original owner or end-user.

Any product reported to the authorized dealer or to Kraus as being defective within the warranty period will be repaired or replaced with a product of equal value at the option of Kraus. This warranty extends to the original owner or end-user, and is not transferable to a subsequent owner.

### Restrictions

This warranty does not cover antediluvian, discontinued, or display products, whether such items are purchased at discount outlets, unauthorized dealers, and/or sold on clearance.

This warranty does not cover instances of negligence, misuse, abuse, improper installation, carelessness, accident, hard water or mineral deposits, exposure to corrosive materials, misapplication, damages caused by improper maintenance, alteration of the product, or failure to follow care or installation instructions enclosed with your product. Avoid using abrasive cleaners such as powders, bleach, ammonia, alcohol, or chlorine. Avoid using abrasive pads, steel wool, or wire brushes, as these will damage and wear down the finish.

This warranty does not apply to Products that have not been installed or operated in accordance with instructions supplied by Kraus and all applicable rules, regulations, and legislation pertaining to such installations.

This warranty does not apply unless the Kraus product is installed by a fully insured and licensed trade professional. Kraus insists that such professionals have experience in the installation of bathroom and kitchen manufactured goods.

This warranty does not cover labor charges or costs of removal and reinstallation of said product. This warranty does not allow recovery of incidental or consequential damages, such as loss of use, delay, property damage, or other consequential damages, and Kraus accepts no liability for such damages.

This warranty does not cover Marine or Outdoor Installation.

This warranty does not cover any free gifts included with purchase.

Except as otherwise provided above, Kraus makes no warranties, expressed or implied, including warranties of merchantability and fitness for a particular purpose, or compliance with any code.

Shipping charges will be covered for the first (1) year of the warranted replacement part or product (HI, AK, and Puerto Rico shipping charges may apply). International shipping fees are not included.

### COMMERCIAL WARRANTY

Kraus extends the above warranty for a period of one (1) year to purchasers of products for industrial, commercial, and business use.

All incidental or consequential damages are specifically excluded. No additional warranties, express or implied, are given, including but not limited to any implied warranty of merchantability or fitness for a particular purpose.

Some states do not allow the exclusion or limitation of incidental or consequential damages or limitations on how long an implied warranty lasts, so the above limitations or exclusions may not apply to you.

This warranty gives you specific legal rights, and you may also have other rights which vary from state to state.

KRAUS USA has the right to change, modify, and/or update the warranty policy at any time. For the latest, most up to date comprehensive warranty, go to [www.kraususa.com/warranty](http://www.kraususa.com/warranty)



**If you are a homeowner please contact a Kraus Customer Service Representative at:**

Kraus USA, Inc.  
12 Harbor Park Drive  
Port Washington, NY 11050  
Toll-free 800-775-0703  
Customerservice@kraususa.com

**If you are a plumbing contractor or trade professional please contact a Kraus Pro Representative at:**

Kraus USA, Inc.  
12 Harbor Park Drive  
Port Washington, NY 11050  
516-801-8955  
Proservice@kraususa.com

**If you are an Authorized Partner please contact a Partner Support Representative at:**

Kraus USA, Inc.  
12 Harbor Park Drive  
Port Washington, NY 11050  
516-801-8954  
Partnersupport@kraususa.com

**In requesting warranty service, please be ready to provide:**

1. Proof of purchase.
2. A description of the problem.

**Download the Kraus Care & Maintenance Guide at:**  
<http://www.kraususa.com/maintenance>

# IMPORTANT

## Register Your Kraus Product

**Activate** Your Warranty

**Access** Premium Customer Support

**Get** Product Information

**REGISTER TODAY**

<http://www.kraususa.com/registration>



**Kräus**<sup>®</sup>  
www.kraususa.com