



INSTRUCTIONS D'ASSEMBLAGE
ASSEMBLY INSTRUCTIONS

MONARCH
SPECIALTIES INC.

I 7322

CHAISE DE BUREAU -
GRIS SIMILI-CUIR / DOSSIER EXECUTIF

OFFICE CHAIR -
GREY LEATHER-LOOK / HIGH BACK EXECUTIVE



POUR DE L'ASSISTANCE OU POUR COMMANDER
DES PIÈCES CONTACTEZ NOTRE DÉPARTEMENT
DE SERVICE À LA CLIENTÈLE.



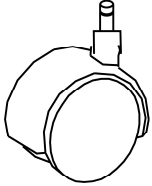
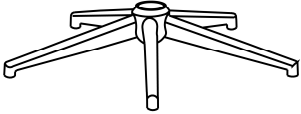
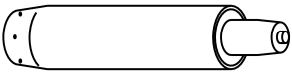
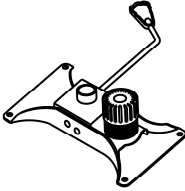
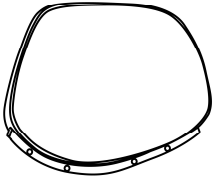

FOR ASSISTANCE OR TO ORDER PARTS
CONTACT OUR CUSTOMER SERVICE DEPARTMENT

WWW.MONARCHSERVICE.COM

LISTE DES PIÈCES
PARTS LIST

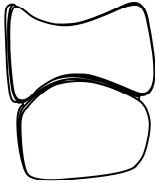
PIÈCE / PART #	IMAGE	DESCRIPTION	QTY / QTÉ
1		<p align="center">CASTOR ROULLETTE</p>	5
2		<p align="center">BASE BASE</p>	1
3		<p align="center">GASLIFT ASCENSEUR À ESSENCE</p>	1
4		<p align="center">CHAIR MECHANISM SEAT PLATE MÉCANISME DE SIÈGE</p>	1
5		<p align="center">HEADREST APPUI TÊTE</p>	1

LISTE DES PIÈCES
PARTS LIST

PIÈCE / PART #	IMAGE	DESCRIPTION	QTY / QTÉ
6		<p>BACK REST DOSSIER</p>	1
7		<p>SEAT CUSHION COUSSIN DU SIÈGE</p>	1
8		<p>FRONT FACING LEFT ARMREST ACCOUDOIR AVANT GAUCHE</p>	1
9		<p>FRONT FACING RIGHT ARMREST ACCOUDOIR AVANT DROIT</p>	1
10		<p>SCREW CAP CAPUCHON DE VIS</p>	1

LISTE DES PIÈCES
PARTS LIST

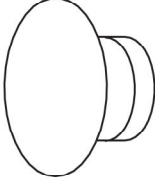
PIÈCE / PART #	IMAGE	DESCRIPTION	QTY / QTÉ
11		SCREW CAP CAPUCHON DE VIS	8

LISTE DES PIÈCES DE MONTAGE
HARDWARE LIST

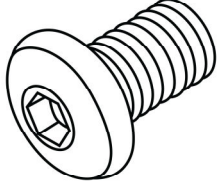
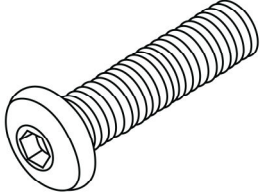
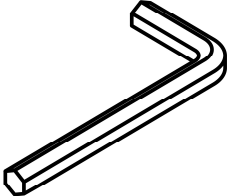
PIÈCE / PART #	IMAGE	DESCRIPTION	QTY / QTÉ
A		<p>ASSEMBLING BOLT - Ø 1/4" X 3/4"</p> <p>BOULON D'ASSEMBLAGE - Ø 1/4" X 3/4"</p>	12
B		<p>ASSEMBLING BOLT - Ø 3/8" X 1"</p> <p>BOULON D'ASSEMBLAGE - Ø 3/8" X 1"</p>	4
C		<p>HEX KEY</p> <p>CLÉ HEXAGONALE</p>	1

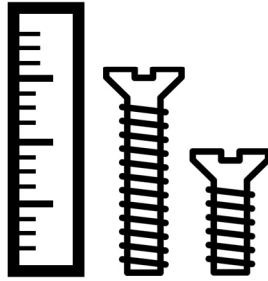

OUTIL DE VÉRIFICATION DE DIMENSIONS DES PIÈCES
HARDWARE DIMENSIONS VERIFICATION TOOL

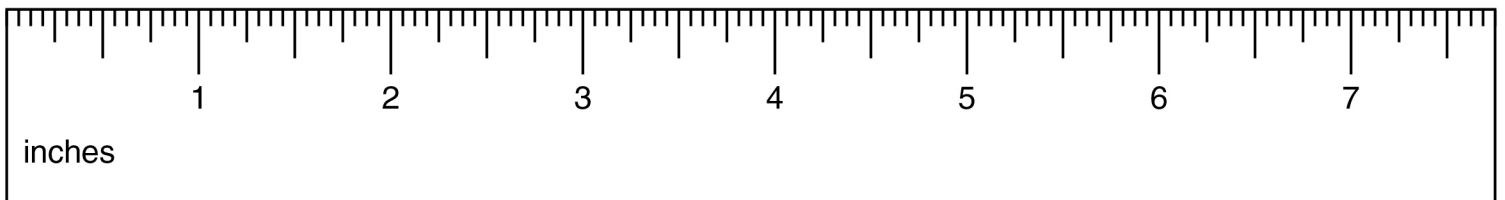

ÉTAPE / STEP 1

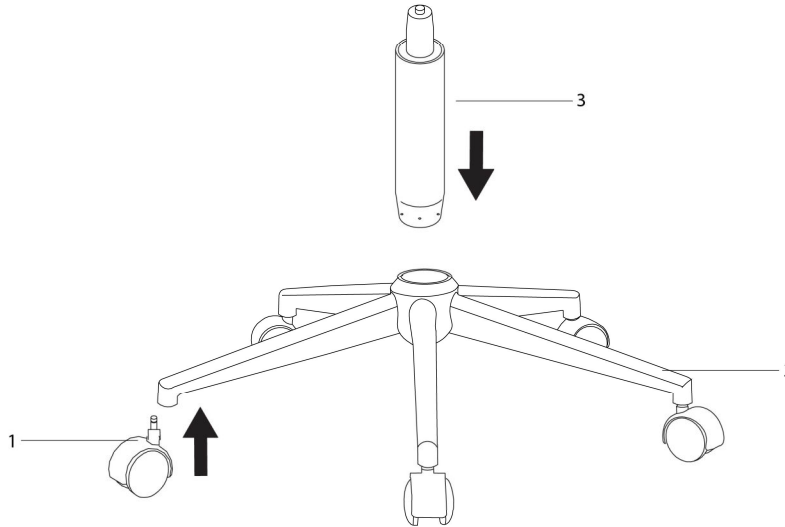

ÉTAPE / STEP 2

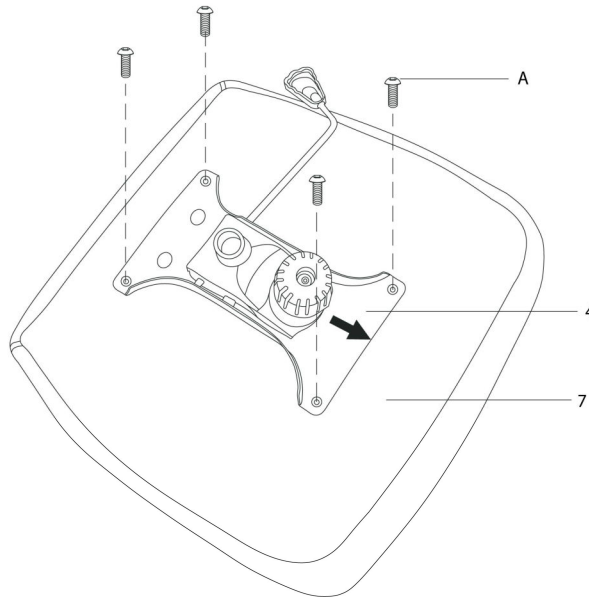

ÉTAPE / STEP 3

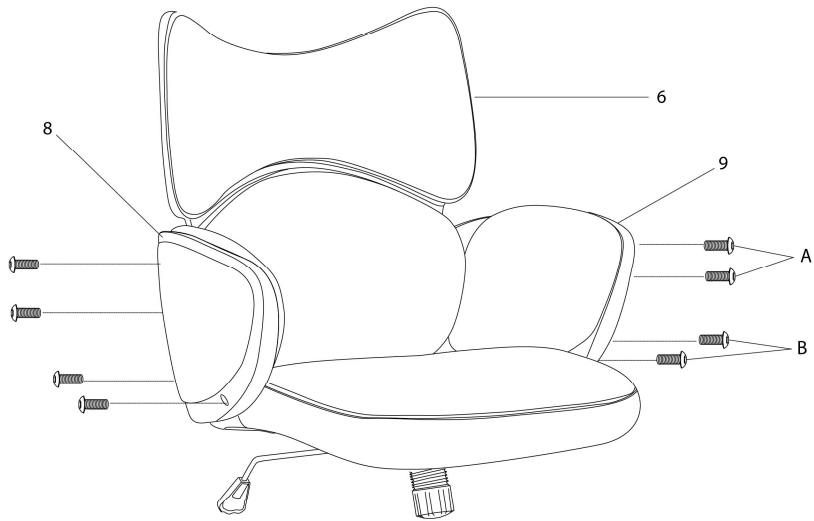

ÉTAPE / STEP 4

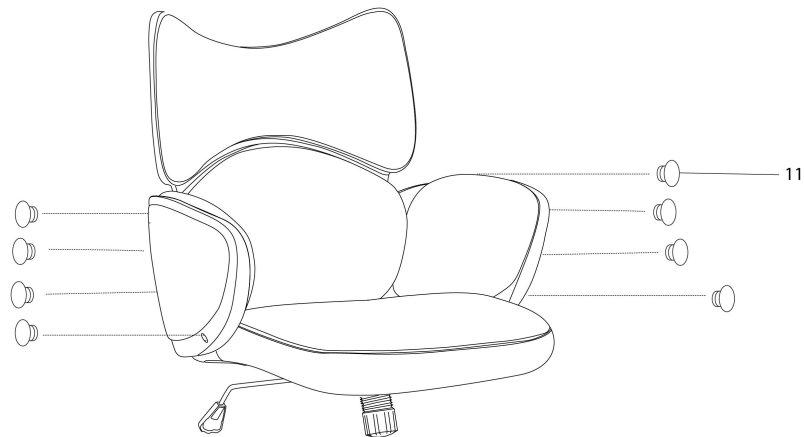

ÉTAPE / STEP 5

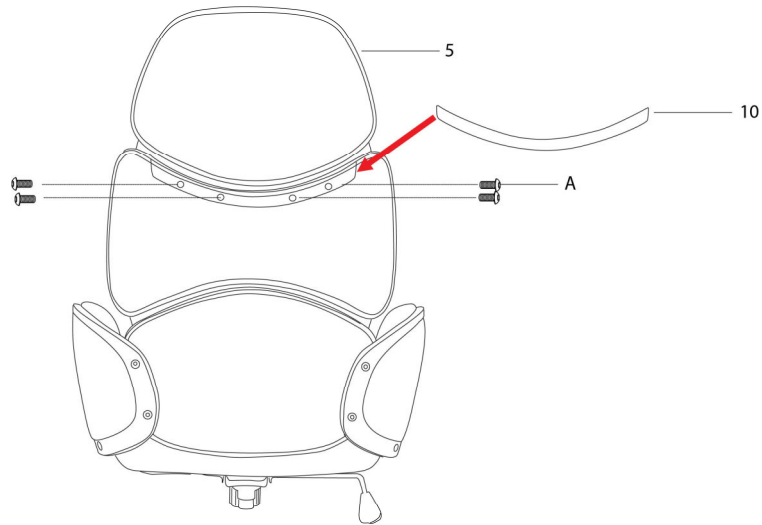

ÉTAPE / STEP 6

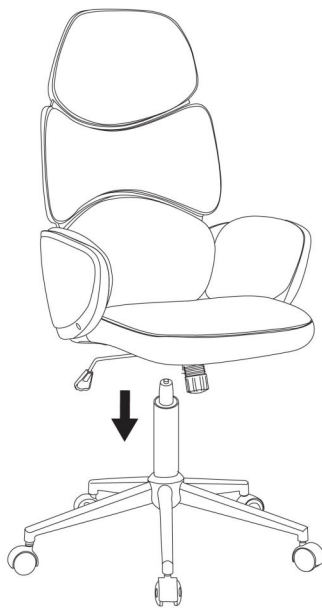

ÉTAPE / STEP 7

