

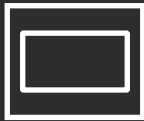

# 5L

OPERATING MANUAL

GUIDE D'UTILISATION



SUPPORT@ONSENPRODUCTS.CA  
ONSENPRODUCTS.CA  
800.996.5559

**onsen**

## **WARNING**

### FIRE OR EXPLOSION HAZARD

If you smell gas:

1. Do not attempt to light appliance and make sure appliance is in the OFF position.
2. Extinguish any nearby flame(s).
3. Shut off cylinder fuel supply valve if so equipped, or if equipped with a disposable fuel cylinder, disconnect the cylinder.
4. Leave the area immediately.
5. Allow gas to dissipate for 5 minutes.
6. If gas smell has dissipated from the area, the appliance, and fuel supply, follow gas connection procedures.

Failure to follow these instructions could result in fire or explosion which could cause property damage, personal injury or death.

## **DANGER**

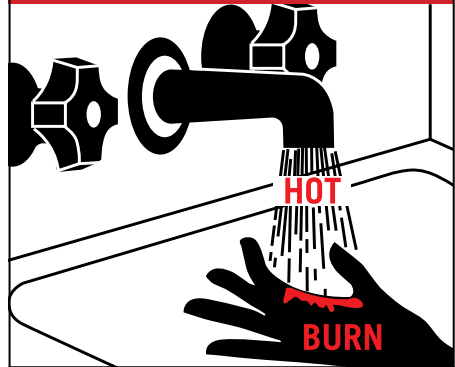

Water temperature over 125°F (52°C) can cause severe burns instantly or death from scalds.

Children, disabled and elderly are at highest risk of being scalded.

See instruction manual before setting temperature at water heater.

Feel water before bathing or showering.

**FOR YOUR SAFETY**

Do not store or use gasoline or other flammable vapors and liquids in the vicinity of this or any other appliance.

** DANGER****CARBON MONOXIDE HAZARD**

This appliance can produce carbon monoxide which has no odor.

Using it in an enclosed space can kill you.

Never use this appliance in an enclosed space such as camper, tent, car or home.

** WARNING**

Improper installation, use, adjustment, alteration, service, or maintenance can cause injury or property damage. Refer to this manual. For assistance or additional information, consult a qualified installer, service agency, or gas supplier.

 **DANGER**

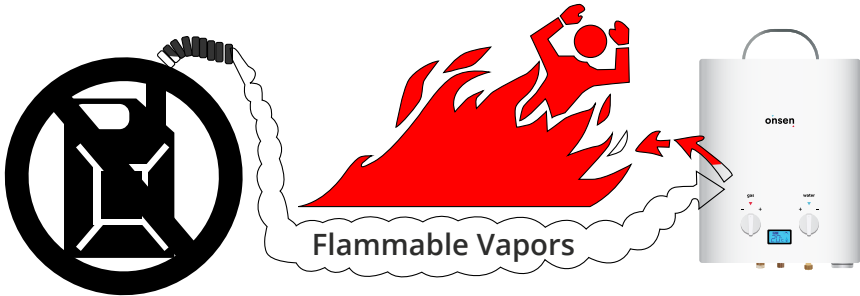

 **Vapors from flammable liquids will explode and catch fire causing death or severe burns.**

Do not use or store flammable products such as gasoline, solvents or adhesives in the same room or area near the water heater.

Keep flammable products:

1. far away from heater,
2. in approved containers,
3. tightly closed and
4. out of children's reach.

Water heater has a main burner flame.  
The main burner flame:

1. can come on at any time and
2. will ignite flammable vapors.

Vapors:

1. cannot be seen,
2. are heavier than air,
3. go a long way on the floor and can be carried from
4. other rooms to the main burner flame by air currents.

**Installation:**

Do not install water heater where flammable products will be stored or used unless the main burner flame is at least 18" above the floor. This will reduce but not eliminate the risk of vapors being ignited by the main burner flame.

Read the following water heater warnings and instructions. If owners manual is missing, contact the retailer or manufacturer.

**Thank you for purchasing the  
ONSEN 5L PORTABLE TANKLESS WATER HEATER**

Before using this gas-powered water heater, it is extremely important to read all of the safety and operation instructions provided in this Operating Manual to ensure that you can enjoy the Onsen 5L safely and responsibly.

If you have any questions about how to use this water heater, please contact **Onsen** at [support@onsenproducts.ca](mailto:support@onsenproducts.ca) or **800-996-5559**.

**Please retain this Operating Manual for future reference.**

## INDEX

Safety Information .....	6
Safety Precautions .....	9
How It Works .....	10
Getting Started .....	11
Installation Requirements .....	15
Use and Operation .....	16
Adjusting the Water Temperature .....	19
Technical Specifications .....	20
Draining the Water Heater .....	23
Maintenance and Cleaning Instructions .....	24
Troubleshooting .....	24
Support .....	28
Warranty .....	29

## SAFETY INFORMATION



**PLEASE MAKE SURE TO READ ALL INSTRUCTIONS BEFORE USING THIS WATER HEATER**

Your safety and the safety of others is extremely important in the installation, use and servicing of this water heater. Safety-related messages, warnings and instructions have been provided in this Operating Manual and the labels affixed to the water heater to warn you and others of potential injury hazards. Read and obey all safety messages and instructions throughout this Operating Manual.



**THIS IS THE SAFETY ALERT SYMBOL. IT IS USED TO ALERT YOU TO POTENTIAL PERSONAL INJURY HAZARDS. OBEY ALL SAFETY MESSAGES THAT FOLLOW THIS SYMBOL TO AVOID POSSIBLE INJURY OR DEATH.**



**DANGER**

DANGER indicates an imminently hazardous situation which, if not avoided, will result in death or injury.



**WARNING**

WARNING indicates a potentially hazardous situation which, if not avoided, could result in death or injury.



**CAUTION**

CAUTION indicates a potentially hazardous situation which, if not avoided, could result in minor or moderate injury.

**GENERAL GAS APPLIANCE WARNINGS AND BEST PRACTICES**** WARNING**

If the information in these instructions is not followed exactly, a fire or explosion may result causing property damage, personal injury, or death.

Keep the area around the water heater clear and free from combustible materials, gasoline, and other flammable vapors and liquids.

Before operating any gas appliance, smell all around the appliance area for gas. Be sure to smell next to the floor because Liquid Propane Gas is heavier than air and will settle on the floor.

Liquid Propane gas is heavier than air and will accumulate at the lowest points in the event of a leak which sometimes makes it difficult to detect at nose level. It is highly recommended to install a gas detector near ground level to detect gas leaks.

This water heater is capable of producing scalding water temperatures. Always check the outgoing water temperature before use.

Hot exhaust and casing may cause serious burns. Keep away from the water heater. Keep small children away from the water heater.

If any of the instructions contained in this Operating Manual are unclear to you, contact a trained and qualified professional to perform the installation.

This water heater is intended to be used with a 20 lb LP gas cylinder only (height: 18 in., tank diameter: 12 in., foot diameter: 8 in.). LP gas cylinders must either be designed, fabricated, tested and marked (or stamped) in accordance with the regulations of the U.S. Department of Transportation (DOT) or for use in Canada, cylinders must be constructed and marked in accordance with the specifications for *Cylinders, Spheres, and Tubes for the Transportation of Dangerous Goods, CSA B339*.

The gas must be turned off at the LP gas supply cylinder when the water heater is not in use.

When the LP gas supply cylinder is not disconnected from the water heater, the water heater and cylinder must be stored outdoors, in a well ventilated space, out of the reach of children, and must not be stored in a building, garage or any other enclosed area.

Storage of the water heater indoors is permissible only if the cylinder is disconnected and removed from the water heater.

Cylinders must be stored outdoors, in a well-ventilated space, out of the reach of children, and must not be stored in a building, garage or any other enclosed area.

Should overheating occur or the gas supply fail to shut off, turn off the manual gas control valve to the appliance.

This water heater is intended for point of use, for temporary water heating and not for connection to a permanent inlet water connection or for connection to a water distribution system to supply multiple outlets.



## SAFETY PRECAUTIONS

- ✓ **THIS WATER HEATER IS FOR OUTDOOR USE ONLY.**
- ✓ **THIS WATER HEATER IS NOT INTENDED FOR PERMANENT INSTALLATION AND CANNOT BE PERMANENTLY PLUMBED IN ANY WAY.**
- ✓ **WHEN NOT IN USE, THE WATER HEATER MUST BE DISCONNECTED AND STORED IN A WARM AND DRY PLACE.**
- ✓ Always use a soapy solution on the gas fittings and connections to detect gas leaks.
- ✓ Do not operate the water heater with Natural Gas. Use only Liquid Propane gas. Do not try to convert this water heater to Natural Gas.
- ✓ If a gas odor is detected, turn off the gas valve on the gas tank immediately.
- ✓ Do not operate the water heater in strong wind conditions.
- ✓ Do not leave the water heater unattended when turned on.
- ✓ Never mount the water heater onto a combustible surface or wall.
- ✓ Any alteration to the water heater or its controls can be dangerous and will void the warranty.
- ✓ Always check the outgoing water temperature before showering or bathing.

### **WARNING**

This water heater is intended for use with non-potable water only (for showering, cleaning, etc.) It is not intended for heating water for human consumption. Consuming water heated by this water heater may result in exposure to bacterial, viral, parasitic or chemical waterborne contaminants harmful to human health.

## HOW IT WORKS

The Onsen 5L Portable Tankless Water Heater uses Liquid Propane gas to heat water by burning a flame on the copper heat exchanger. The incoming water is heated when it circulates through the heat exchanger before being directed to the water outlet (showerhead). The temperature of the exiting water can be increased by turning the gas knob on the water heater, which increases the flame output, or by turning the water knob to decrease water flow.

The water heater is equipped with an electronic ignition system that uses 2 “D” type batteries or 12 volt for ignition. The ignition system is pressure controlled, which means the flame will only ignite if the water circulating inside has a sustained pressure of 10 to 80 PSI. When the water flow is cut off (by shutting off the water source or turning the showerhead to the OFF position), the flame shuts off automatically.



# GETTING STARTED

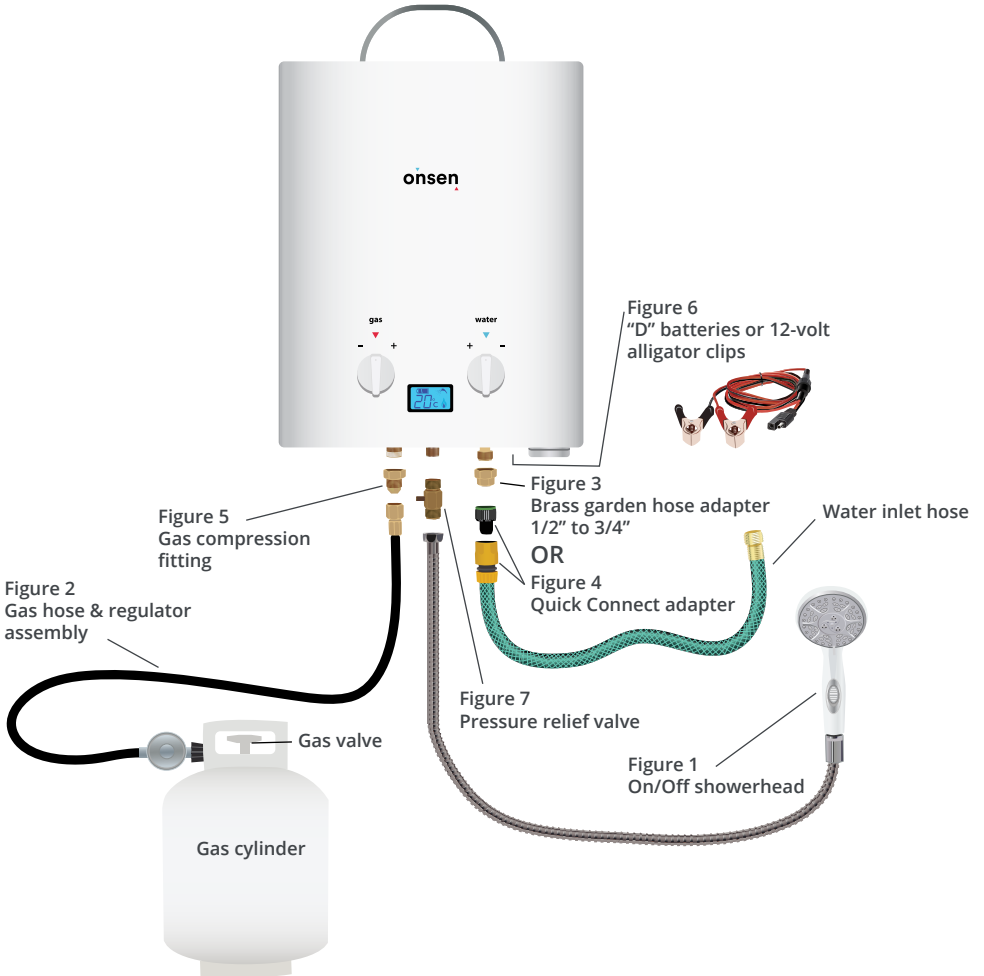

- ① Check the box for any damage sustained during shipment.
- ② Check that all components and accessories are included in the box:
  - ✓ Water heater
  - ✓ Gas hose & regulator assembly (factory connected to water heater)
  - ✓ Showerhead set
  - ✓ Garden hose adapter
  - ✓ Hardware pack
  - ✓ 12 volt battery alligator clips
  - ✓ Pressure relief valve
- ③ Connect the water inlet:
  - ✓ Apply Teflon to the threads of the water inlet to ensure a sealed connection and to prevent leaking.
  - ✓ Attach the 1/2" to 3/4" brass garden hose adapter (Fig. 3) to the Teflon coated threads of the water inlet. Connect a garden hose to the garden hose adapter.  
**OR**  
Attach the male Quick Connect adaptor (Fig. 4) to the Teflon coated threads of the water inlet and the female Quick Connect Adaptor to a garden hose. Connect the garden hose to the water inlet by clicking the female and male adaptors together.

#### ④ Connect the water outlet:

- ✓ Connect the pressure relief valve (Fig. 7) to the water outlet of the water heater, then connect the On/Off showerhead hose (Fig. 1) to the relief valve.

#### ⑤ Check the gas inlet:

- ✓ Check the connection of the gas regulator hose to the 3/8" gas compression fitting of the gas inlet of the water heater (Fig. 5) (the gas regulator hose should already be connected to the gas fitting). If necessary, use a wrench to ensure a secure connection. **DO NOT OVERTIGHTEN AS THIS MAY CAUSE A CRACK IN THE GAS CONNECTION AND RESULT IN A GAS LEAK.**

*(WARNING: Do not apply gas tape, compound or other sealant to the threads of the 3/8" gas compression fitting. The fitting is flared and does not require sealant. Applying sealant to the threads of the fitting may prevent a secure connection, resulting in a gas leak).*

#### ⑥ Install batteries / connect 12 volt ignition:

- ✓ If using 2 "D" type batteries for ignition, install the batteries in the battery box located on the bottom right of the water heater (Fig. 6). Alternatively, if using 12 volt for ignition, connect the circular connector of the included 12 volt alligator clip to the 12 volt input connection at the bottom of the water heater (Fig. 6). Next, connect the alligator clips to a 12 volt battery by connecting the positive red wire to the positive (+) terminal of your battery and the negative black wire to the negative (-) terminal of your battery.

*(WARNING: Do not reverse the positive (+) and negative (-) connections as this could damage the alligator clip accessory as well as the 12 volt ignition module of the water heater.)*

**Note:** When using both batteries and 12 volt for ignition, the 12 volt takes priority.

7 Hang the water heater:

- ✓ Hang the water heater using the bottom and top brackets onto the included mounting screws.

8 Connect 20 lb LP gas tank:

- ✓ Connect the gas regulator hose (Fig. 2) to a 20 lb LP gas tank. DO NOT OPEN THE TANK'S GAS VALVE YET.

CONNECTING THE LP TANK

- 1 The knob on the LP tank must be closed. Make sure that the knob is turned clockwise to a full stop. The cylinder supply system must be arranged for vapor withdrawal.
  - 2 Check that the ON/OFF button located at the bottom of the water heater is in the OFF position.
  - 3 Remove the protective cap from the LP tank valve and coupling nut.
  - 4 Hold the regulator in one hand and insert the nipple into the valve outlet. Be sure the nipple is centered in the valve outlet. The coupling nut connects to the large outside threads on the valve outlet. Use care – do not cross thread the connection.
  - 5 Hand tighten the coupling nut clockwise until it comes to a full stop. Firmly tighten by hand only. Do not use tools.
- To disconnect:** Fully close the tank valve by turning clockwise. Turn the coupling nut counter-clockwise until the regulator assembly detaches.

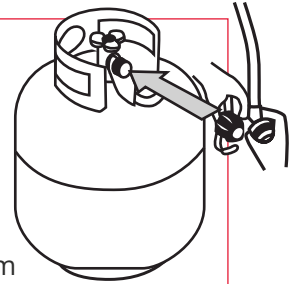

The propane cylinder must be arranged for vapor withdrawal and equipped with a listed overfilling prevention device (required on all 4 to 40 pound cylinders in Canada and the US). Please use the proper cylinder orientation to provide vapor withdrawal. NOTE: The cylinder must be fully upright for the cylinder to have vapor withdrawal only.



CORRECT



WRONG



WRONG

## INSTALLATION REQUIREMENTS



- ✓ This water heater should be installed outdoors only.
- ✓ Do not install this water heater in an enclosed space.
- ✓ Do not install this water heater where flammable materials are stored or used.
- ✓ Install the water heater in a vertical position at eye level.
- ✓ Install the water heater with the following minimum clearance distances from flammable materials or liquid: 31.5 in. (800 mm) top, 10 in. (250 mm) sides, and 1 in. (25.4 mm) back.

## USE AND OPERATION

**⚠ DANGER**

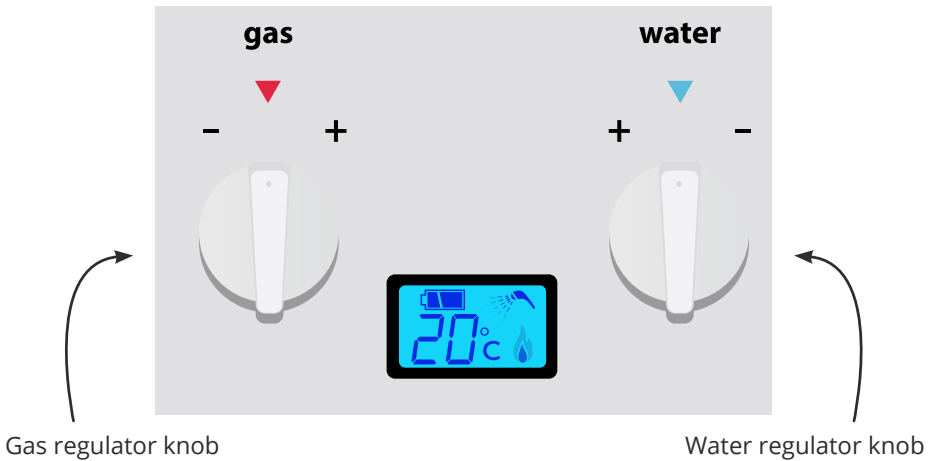
Always check for gas leaks before using this water heater. To do so, spray a mixed solution of water and soap on the gas inlet connection. If bubbles start to form, close the gas valve and seal the gas connection properly before repeating the gas leak test.



- ① Set the water regulator knob to maximum **+** setting (turn counter-clockwise ).
- ② Set the gas regulator knob to minimum **-** setting (turn counter-clockwise ).
- ③ Ensure the showerhead button is in the OFF position .



- ④ Turn on the incoming water supply and wait for the water lines to completely fill with water (water pressure must be between 10 – 80 PSI for ignition to occur).
- ⑤ Open the gas valve on the LP gas tank.
- ⑥ **IMPORTANT:** Check for gas leaks by spraying a mixed solution of water and soap on the gas inlet connection. If bubbles start to form, close the gas valve and seal the gas connection properly before repeating the gas leak test.

**⚠ DANGER**

This water heater comes with a ½" – ¾" gas compression fitting already connected to the ½" gas inlet during the assembly portion of the manufacturing process. In the event that the gas compression fitting has been removed, make sure to connect it by applying gas tape or compound to the ½" gas inlet threads to ensure the connection is sealed and to prevent a gas leak. ALWAYS CHECK FOR GAS LEAKS AFTER APPLYING GAS TAPE / COMPOUND.

- ⑦ Push button located at the bottom of the water heater to the ON position.
- ⑧ Push the showerhead button to the ON position  (this will allow for water to circulate inside the water heater and kick start the ignition sequence).
- ⑨ You will hear a series of clicks followed by the sound of the flame igniting, similar to an outdoor grill. If the flame does not ignite after 5 seconds, shut off the water supply and close the gas valve. Go to Troubleshooting on page 24 of this Operating Manual for advice.

A yellow warning icon consisting of a black triangle with a white exclamation mark inside.

**WARNING**

During flame ignition, do not expose this water heater to flammable vapors or liquids.

### IMPORTANT TO KNOW

- ▶ This water heater is equipped with a water temperature sensor that will turn off the flame when 50 °C is reached.
- ▶ This water heater is equipped with a 20 minute safety shut-off timer that will automatically turn off the flame when this timeframe is reached. To start the water heater again, push the showerhead button OFF and ON to reignite the flame.

## ADJUSTING THE WATER TEMPERATURE

**WARNING: THIS WATER HEATER MAY PRODUCE SCALDING WATER TEMPERATURES. USE EXTREME CAUTION WHEN OPERATING THIS WATER HEATER.**

Follow these steps to adjust the outgoing water temperature:

- ① Set the water heater to the lowest setting available by turning the water regulator knob to maximum and the gas regulator knob to minimum. Carefully check the water temperature.
- ② To raise the water temperature, turn the gas knob slowly towards maximum, checking the water temperature often. Wait several seconds after turning the gas knob before checking the temperature.
- ③ To further raise the water temperature once the gas knob is at maximum, turn the water knob slowly towards minimum, checking the water temperature often until the desired temperature is achieved.
- ④ The digital screen between the gas and water knobs displays the temperature of the outgoing water. Adjust the gas and water knobs to achieve the desired temperature.

# TECHNICAL SPECIFICATIONS

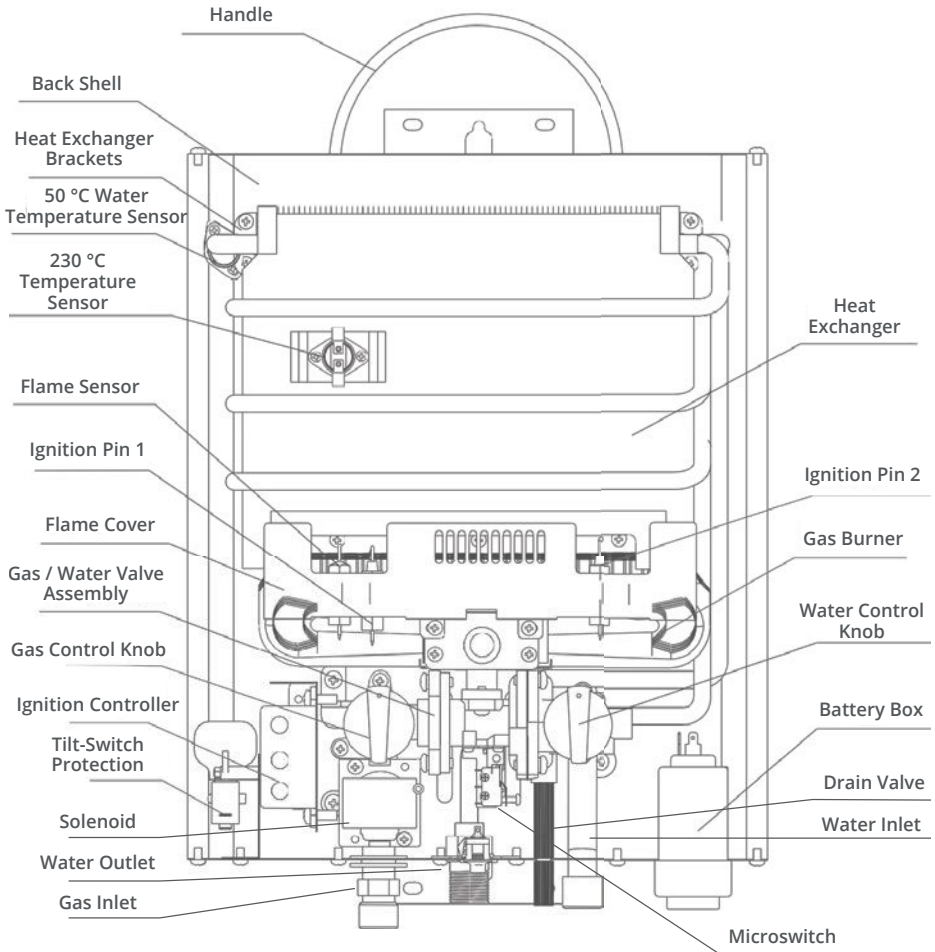

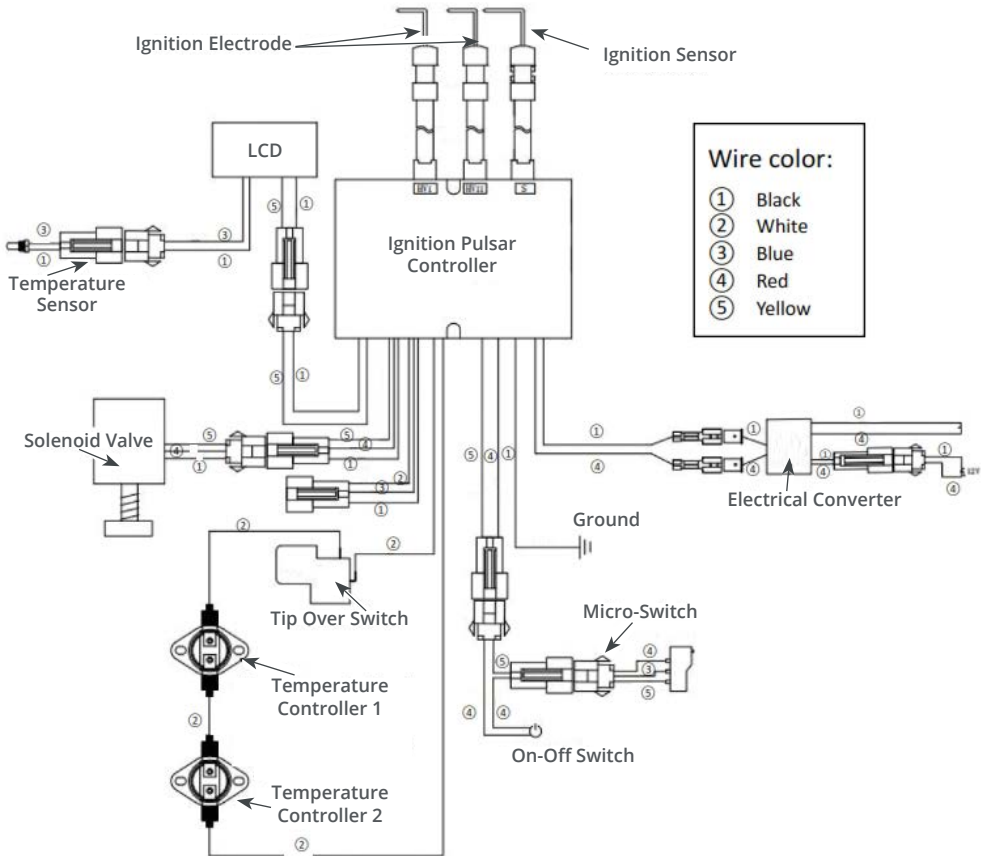

## ONSEN 5L PORTABLE TANKLESS WATER HEATER

Fuel Type	LP (Liquid Propane)
Model	5L
Activation Flow Rate	10 – 80 PSI
BTU/h	32,000
Manifold Pressure	11 in. W.C.
Ignition	2 “D” batteries / 12 volt
Protections	Anti-dry combustion protection, over-pressure, overheating and flame-out protection
Weight	10.5 lbs
Dimensions	14.6 × 11.8 × 4.9 in.
Pipe Fittings	1/2” incoming / outgoing water & gas

### TEMPERATURE INCREASE BASED ON FLOW RATE:

Model	Gas Setting	0.8 GPM / 3.0 LPM	1.32 GPM / 5.0 LPM	1.8 GPM / 6.8 LPM
Onsen 5L	Highest	29 °C / 52 °F	16.5 °C / 30 °F	13 °C / 23.5 °F
	Lowest	8.7 °C / 15.5 °F	7 °C / 12.5 °F	4.5 °C / 8 °F

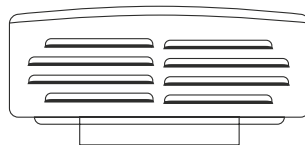
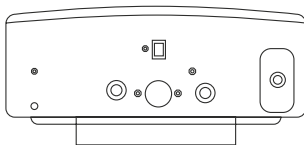

**⚠ CAUTION**

Label all wires prior to disconnection when servicing controls. Wiring errors can cause improper and dangerous operation.

**⚠ CAUTION**

Verify proper operation after servicing.

## DRAINING THE WATER HEATER

Freeze damage is the most common defect affecting portable water heaters and is not covered by the warranty. Freeze damage can easily be prevented by manually draining the water heater and storing it in a warm place when not in use.

During freezing temperatures, ensure the water heater is properly drained by following these steps:

- ① Shut off the incoming water supply and the gas supply.
- ② Use a flat-head screwdriver to turn the drain valve stem (located at the bottom of the water heater) counter-clockwise until water starts to drain.
- ③ Disconnect the water inlet and outlet lines.
- ④ Using an air compressor, blow compressed air into the water inlet to drain any excess water remaining in the heat exchanger piping. This ensures the water heater is completely drained of water and will prevent the internal piping from freezing and possibly bursting in cold temperatures.
- ⑤ Store in a warm area.

## MAINTENANCE AND CLEANING INSTRUCTIONS

- ① Keep the water heater installation area clear and free from combustible materials, gasoline and other flammable vapors and liquids.
- ② During use, do not obstruct the flow of combustion and ventilation air.
- ③ Visually check the burner flame during use for abnormal burning (e.g. flame-back, flameout, yellow flame or black smoke).
- ④ Descale your water heater at least once a year to prevent scaling inside the piping. This can be done by circulating a mixture of water and vinegar in the water heater for approximately 5 minutes.

## TROUBLESHOOTING

### WATER HEATER DOES NOT TURN ON AND NO AUDIBLE CLICKS

- ▶ Ensure the ON/OFF switch at the bottom of the water heater is in the ON position.
- ▶ Ensure the 2 “D” batteries are in working condition and inserted properly in the correct position. If using the 12 volt feature for ignition, ensure the 12 volt accessory is connected properly on both ends (water heater and 12 volt power source). Ensure the 12 volt power source (ex: 12 volt battery) is not depleted and working properly.



- ▶ Ensure the incoming water hose is connected to the water inlet of the water heater and the outgoing water hose (shower set) is connected to the water outlet. The water heater will not ignite if the connections are reversed.
- ▶ Check for debris in the water heater's water inlet. The presence of debris in the water inlet screen may affect the incoming water pressure, which could prevent the flame from igniting.
- ▶ Verify the water pressure. The primary cause of non-ignition is insufficient water pressure. The water heater requires a minimum 10 PSI of sustained water pressure to ignite the burner. Municipal water pressure is commonly rated at 60 PSI while most water pumps are rated at 40 – 60 PSI.
- ▶ If using a water pump for water pressure, try connecting the water heater to municipal water pressure instead. Water pumps can sometimes provide mixed results based on the specifications and the connection configuration between the pump and water heater. Connecting the water heater to a different water pressure source is the best way to determine if the problem is due to a configuration issue or a defective water heater.
- ▶ Check for any possible disconnected wires inside the water heater, which can sometimes occur during shipping. If a wire is disconnected, there will be no audible clicking sound from the ignition pins. To check the wires, ensure the gas supply is turned off, pull off the gas and water regulator knobs, and remove the screws holding the front panel in place. Remove the front panel and locate the disconnected wires toward the bottom of the water heater.
- ▶ The ignition controller may be defective. Please contact **Onsen** at: [support@onsenproducts.ca](mailto:support@onsenproducts.ca) or **800-996-5559**.

## WATER HEATER DOES NOT TURN ON BUT CLICKS ARE AUDIBLE

- ▶ Ensure the LP gas tank is not depleted.
- ▶ Check for debris in the water heater's gas inlet and the opening of the gas regulator hose connected to the inlet. The presence of debris may prevent gas from flowing normally into the water heater.
- ▶ The solenoid may be defective. Please contact **Onsen** at: [support@onsenproducts.ca](mailto:support@onsenproducts.ca) or 800-996-5559.

## WATER HEATER TURNS OFF AFTER APPROXIMATELY 10 SECONDS

- ▶ The water temperature sensor may be defective. Please contact **Onsen** at [support@onsenproducts.ca](mailto:support@onsenproducts.ca) or 800-996-5559.

## WATER HEATER TURNS OFF AT VARIOUS TIME INTERVALS

- ▶ The water heater is equipped with a water temperature sensor that, for safety purposes, will turn off the flame when 50 °C is reached. To restart the water heater, turn the showerhead to the OFF position to stop the water from flowing and then turn the showerhead to the ON position to re-activate water flow and the unit will restart normally.
- ▶ The water heater is equipped with a 20 minute safety shut-off timer that will automatically extinguish the flame when this timeframe is reached. To start the water heater again, push the showerhead button OFF and ON to reignite the flame.
- ▶ In high wind environments, the flame may be extinguished by wind entering the casing. Test the water heater in an area with little to no wind.

- ▶ Verify the water heater is connected to a sustained 10 – 80 PSI water pressure source. Sudden drops in water pressure by a water pump or municipal water source may cause the flame to be extinguished. Test the water heater by connecting to an alternate water pressure source. If the water heater operates normally then, it means that the irregular water pressure in the previous setup is at fault.
- ▶ Sustained water pressure may be affected when a water pump is used for two applications simultaneously (ex: cold water line and hot water line via the water heater), splitting the pressure output in half. In that case, the water pressure may not be sufficient for ignition to occur. Test by connecting the pump to the water heater ONLY. If the water heater operates normally then, it means that the insufficient water pressure in the previous setup is at fault.

## SUPPORT

Model: **Onsen 5L**

For support in French or English contact **Onsen** at:  
**support@onsenproducts.ca** or **800-996-5559**.

To obtain replacement parts, contact **Onsen** at:  
**support@onsenproducts.ca** or **800-996-5559** or visit our website at  
**onsenproducts.ca**.

### **Onsen**

2426 rue de la Province  
Longueuil, QC J4G 1G1 Canada

# WARRANTY

## ONSEN LIMITED WARRANTY

### Limited Warranty Coverage

This Limited Warranty covers any product defects in material or workmanship under normal use and maintenance when installed and operated according to the Operating Manual.

During the Warranty Period, Onsen will repair or replace, at no charge, products or parts of a product that proves defective because of improper material or workmanship, under normal use and maintenance when installed and operated according to the Operating Manual.

*Except as expressly set forth herein, there are no representations or warranties, express or implied, including, without limitation, as to merchantability or fitness for a particular purpose with respect to any goods sold hereunder. Buyer's exclusive remedy is limited to repair or replacement of the goods sold, at Onsen's discretion. Onsen shall not be liable for incidental or consequential damages.*

### Limited Warranty Period

The Warranty Period is as follows:

- **2 YEARS** from date of purchase on Parts
- **30 DAYS** from date of purchase on Accessories

## Limited Warranty Exclusions

This Limited Warranty becomes null and void if product failure is determined to be the result of any of the following:

- ① Careless operation or handling, misuse, abuse and/or lack of maintenance or use not in accordance with the Onsen Operating Manual.
- ② Freeze damage.
- ③ Installation in a corrosive or otherwise destructive environment.
- ④ Inadequate water quality.
- ⑤ Incorrect gas or water pressure.
- ⑥ Scale buildup.
- ⑦ When used as a pool heater.
- ⑧ Product is used in a hot water circulation loop (ex: in-floor heating).
- ⑨ Acts of Force Majeure.

## Limited Warranty Claims and Shipping Costs

All warranty claims must be pre-approved by Onsen before shipment of products and/or parts.

Any warranty related shipments to Onsen that have not been pre-approved by Onsen will be the responsibility of the shipper.

For pre-approved warranty claims, responsibility for shipping costs will be allocated as follows:

- ▶ Within **60 DAYS** of the date of purchase: ground shipping within Canada only (territories excluded) will be covered by Onsen with the carrier of Onsen's choosing.
- ▶ After **60 DAYS** of the date of purchase: customer is responsible for shipping costs.

SUPPORT@ONSENPRODUITS.CA  
ONSENPRODUITS.CA  
800.996.5559

The logo for 'onsen' features the word in a white, lowercase, sans-serif font. A small blue downward-pointing triangle is positioned above the letter 'n', and a small red upward-pointing triangle is positioned below the letter 'n'.