

# KWF210-33

## 33 Inch Farmhouse Workstation Single Bowl Stainless Steel Kitchen Sink

# Kräus<sup>®</sup>

SPECIFICATION SHEET

### Sink Dimensions

Overall Dimensions: 32 7/8" x 20 1/4"

Bowl Dimensions: 31" x 16"

Sink Depth: 10"

### Features

- 16 Gauge
- Farmhouse Installation
- Single Bowl Sink
- Required Minimum Cabinet Size: 36"
- Rear Off-Set Drain
- 3 1/2" Drain Opening
- NoiseDefend Undercoating and Sound Dampening Pads

### Accessories Included

- Strainer ST-1
- Cover Cap STC-2
- Bottom Grid KBG-UN1-33
- Rolling Mat KRM-11BL
- Cutting Board KCB-WS103BB
- Cut-Out Template
- Mounting Hardware

### CODES/STANDARDS:

#### Product Certification

cUPC (ASME A112.19.3/CSA B45.4)

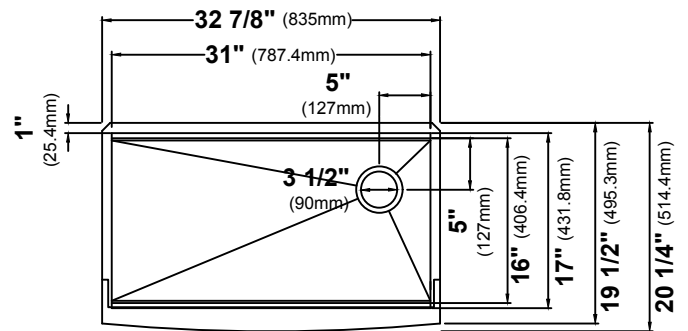

### Warranty

Kraus Limited Lifetime Warranty

see website for details [www.kraususa.com](http://www.kraususa.com)

Kraus USA Customer Service

1.800.775.0703 | [customerservice@kraususa.com](mailto:customerservice@kraususa.com)

REV. October 15, 2019