

Features

- 30-inch minimum base cabinet width.
- Single bowl.
- 9" depth provides generous workspace.
- Single faucet hole.
- Bowl slopes 2 degrees toward drain to minimize water pooling.
- Offset drain increases workspace in the sink and storage space underneath.
- Includes K-9137 bottom sink rack.

Material

- KOHLER® enameled cast iron.

Installation

- Top-mount.

Recommended Products/Accessories

- K-8801 Sink Strainer
- K-8799 Sink Strainer
- K-23726 Drain treatment
- K-23725 Cast iron cleaner

Optional Products/Accessories

- K-11352 Disposal Flange with Stopper
- K-9000 P-Trap

Included Components

- Product consists of:
- K-9137 Sink Rack



Codes/Standards











ASME A112.19.1/CSA B45.2

KOHLER® Enameled Cast Iron Kitchen Sink Lifetime Limited Warranty

See website for detailed warranty information.

Available Colors/Finishes

Color tiles intended for reference only.

Color	Code	Description
	0	White
	FF	Sea Salt™
	96	Biscuit
	47	Almond
	FD	Cane Sugar™
	95	Ice™ Grey
	G9	Sandbar
	K4	Cashmere
	20	Suede
	KA	Black 'n Tan
	7	Black Black™

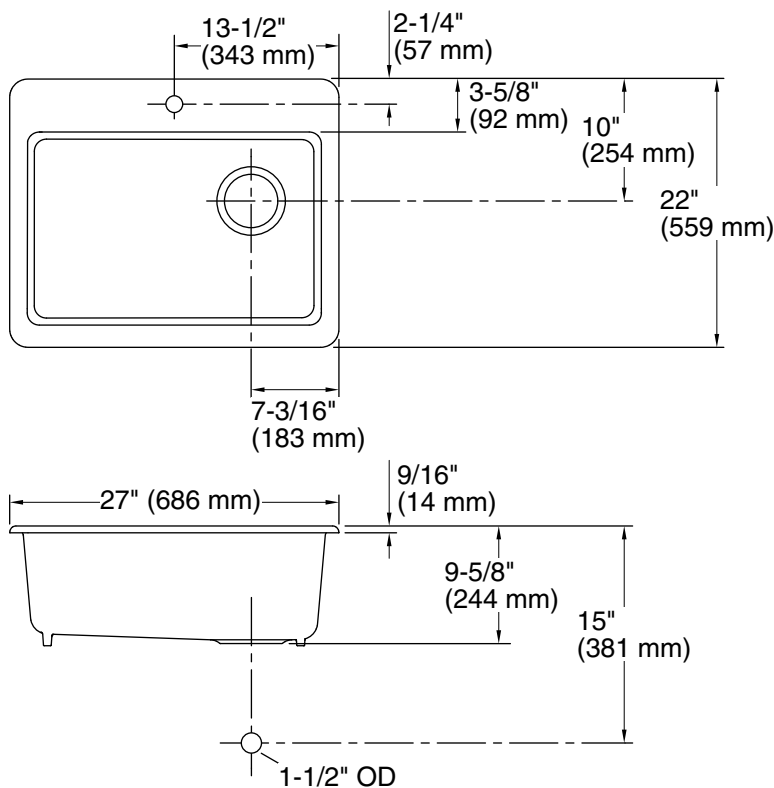

Technical Information

All product dimensions are nominal.

Bowl configuration:	Single
Installation:	Top-mount
Min. base cabinet width:	27" (686 mm)
Bowl area:	Length: 24-1/4" (616 mm) Width: 17-1/4" (438 mm) Bowl depth: 9" (229 mm) Water depth: 9" (229 mm)
Drain hole:	3-7/8" (98 mm)
Template:	1244382-7, required, included

Notes

Install this product according to the installation instructions.